

User Manual

Indoor HD Pan/Tilt Wireless IP Camera with P2P



Model: FI9821P
Color: Black/White



Model: FI9826P
Color: Black/White



Model: FI9831P
Color: Black/White



Model: FI9816P/FI9815P
Color: Black/White

Table of Contents

1 Overview.....	1
1.1 Key Features.....	1
1.2 Read Before Use.....	2
1.3 Package Contents.....	2
1.4 Physical Description.....	2
1.5 Hardware Installation.....	5
2 Access the IP Camera.....	6
2.1 Hardware Connection & Software Installation.....	6
2.2 Access the Camera in LAN.....	6
2.3 Access the Camera in WAN.....	8
2.4 Using the VLC player.....	11
2.5 IP camera connection to the server.....	13
3 Surveillance Software GUI.....	14
3.1 login Window.....	14
3.2 Setup Wizard.....	15
3.3 Surveillance Window.....	17
4 Advanced Camera Settings.....	25
4.1 Setup Wizard.....	25
4.2 Status.....	25
4.3 Basic Settings.....	27
4.4 Network.....	35
4.5 Video.....	46
4.6 Alarm.....	50
4.7 Record.....	56
4.8 PTZ.....	60
4.9 Firewall.....	65
4.10 System.....	65
5 Playback.....	69
6 Appendix.....	71
6.1 Frequently Asked Questions.....	71
6.2 Default Parameters.....	78
6.3 Specifications.....	79
6.4 CE & FCC.....	81
6.5 Warranty.....	82
7 Obtaining Technical Support.....	85

1 Overview

FOSCAM Indoor HD IP Camera is an integrated wireless IP Camera with a color CMOS sensor which enable to view in High Definition resolution. It combines a high quality digital video camera, with a powerful web server, to bring clear video to your desktop and mobile devices no matter where by your local network or over the Internet.

These cameras support P2P function. Thanks to the P2P easy access technology, you don't need to do complicated Port Forwarding and DDNS settings, you just need to scan the QR code on the bottom of the camera to connect it to smart phone, or input the UID on CMS software to realize remote access.

With flexible move of 300-degree horizontally and 120-degree vertically(FI9826P:With flexible move of 300-degree horizontally and 100-degree vertically), FOSCAM IP Camera provides users with more comprehensive controls over a monitored site. The camera supports H.264 video compression technology, dramatically reduces file size and saves network bandwidth.

The camera is based on the TCP/IP standard. A built-in WEB server inside which could support Internet Explorer simplifies the management and maintenance of your device is simplified by accessing the website of your camera through network.

The camera is designed for indoor surveillance with wide applications such as at home, in retail store and in office. Controlling the camera and managing images are simplified by using the provided web interface across the network in either wired or wireless way.

FOSCAM provides Smart Phone App for Android and iPhone users, please search and install Foscam App named **Foscam** on App Store and Google Play for iOS and Android devices, then you can view your camera anywhere, anytime on your smart mobile devices.

1.1 Key Features

- Standard H.264 video compression algorithm to satisfy the transmission of high definition video in narrow bandwidth network
- P2P feature for easy access
- Megapixel HD video
- Pan 300 degree, tilt 120 degree(FI9826P:Pan 300 degree, tilt 100 degree)
- Support IE/Firefox/Google/Safari browser
- Support WEP,WPA-PSK and WPA2-PSK Encryption
- Wireless connection is compliant with IEEE 802.11b/g/n WI-FI, up to 150Mbps
- IR night vision (Range: 8m)
- Support image snapshot
- Support dual-stream
- Support SD Card storage up to 32GB
- Support IR-Cut auto switch

- Embedded free FOSCAM DDNS(dynamic domain name service) Service
- Supporting the Third Party Domain Name Service
- Support two-way audio
- Support ONVIF protocols
- Multi-level users management with password protection
- Motion detection alert via email or upload image to FTP
- Provide free Android and iPhone APP for viewing live video provide free Central Management Software to manage and monitor multiple cameras
- Support record schedule

1.2 Read Before Use

Please first verify that all contents received are complete according to the Package Contents listed below. Before the IP Camera is installed, please carefully read and follow the instructions in the Quick Installation Guide to avoid damage due to faulty assembly and installation. It also ensures the product is used properly as intended.

1.3 Package Contents

● IP Camera × 1	● DC Power Adapter × 1
● WI-FI Antenna × 1	● Mounting bracket × 1
● Ethernet Cable × 1	● CD×1
● Quick Installation Guide × 1	● Warranty Card × 1

1.4 Physical Description

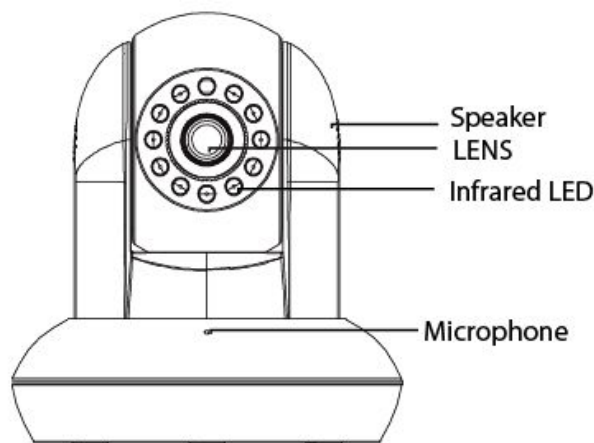

1.Speaker: Built-in speaker

2.LENS: Fixed focus lens (only FI9826P supports optical zoom).

3.Infrared LED: Infrared LEDs for night vision

4.Microphone: Built-in microphone

5.WI-FI Antenna: Wireless Antenna

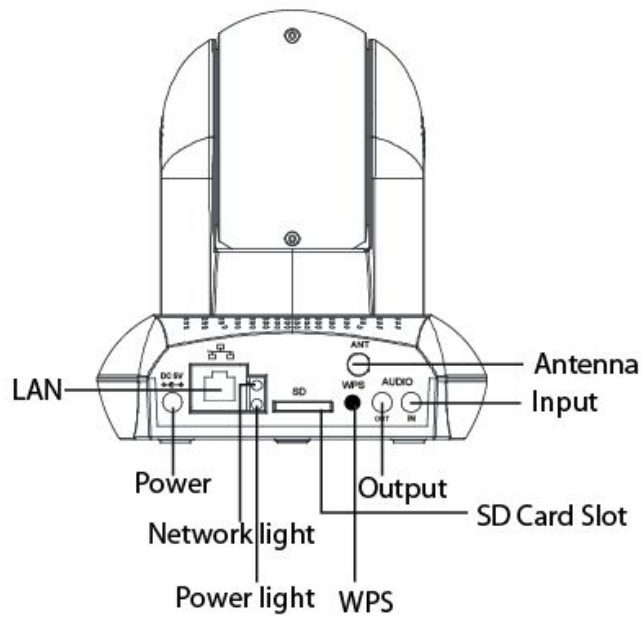

- LAN: 10/100 Mbps RJ-45 port for wired connection
- Power: DC 5V/2A Power supply
- WPS: Push both WPS button on the camera and wireless router within 1 minute, the camera will connect to the wireless router automatically, in WPS process, the Network Light will blink very fast
- SD card Slot: Supports up to 32GB SD card for storing the video
- Output: This jack is used to plug an external speaker
- Input: This jack is used to plug an external microphone
- Antenna: Used to connect external wireless antenna

Bottom View

There are some labels located of the camera; this is an important feature of original Foscam cameras. If your camera does not have labels, it may be a clone. Cloned Foscam cameras can not use original firmware and are not eligible for warranty or technical services.

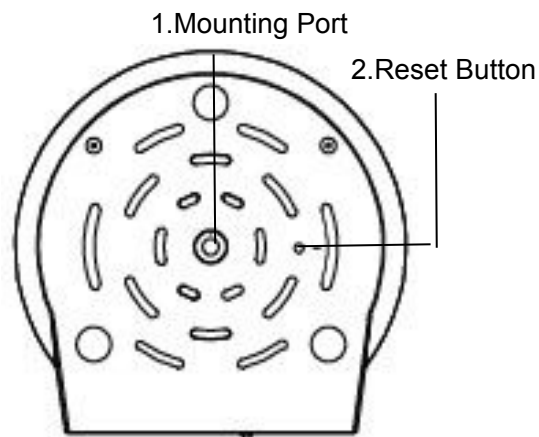

1. Mounting Port: Port for mounting bracket
2. Reset Button: Push and hold for more than 5 seconds to set the camera to factory default

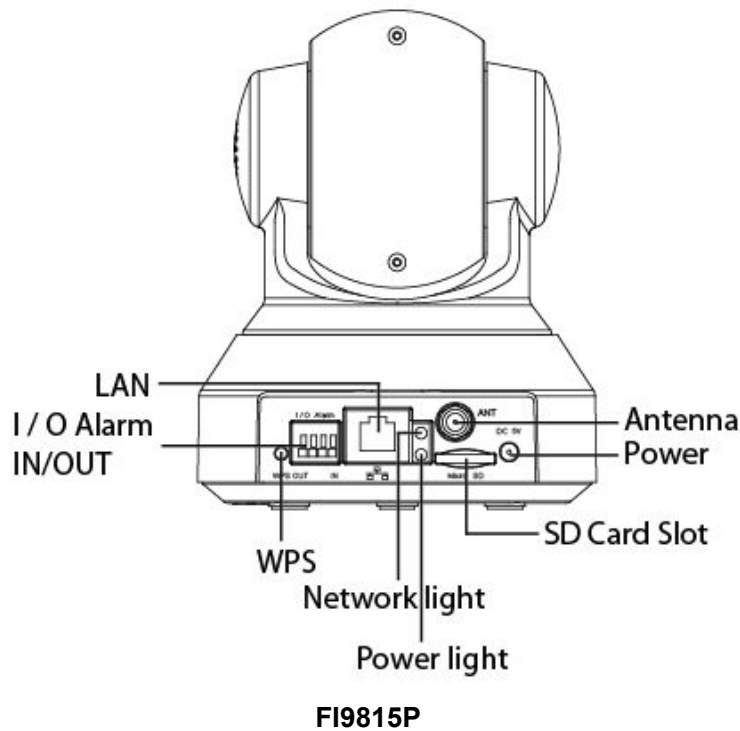

NOTE:

The different features between the models involved.

Differences						
Model	Maxmium Resolution	3x Optical Zoom	SD Card Slot	Micro SD Card Slot	Antenna	P2P
FI9821P	1280*720	×	×	√	Detachable	√
FI9826P	1280*960	√	×	√	Detachable	√
FI9831P	1280*960	×	×	√	Detachable	√
FI9816P	1280*720	×	×	√	Detachable	√
FI9815P	1280*720	×	×	√	Detachable	√

The flashing status of the Power light and Network light are shown in the following table.

Light	Flashing Status	Description
Power light	off	The power don't work properly.
	on	The power supply works fine.
Network light	off	No Wireless connection
	Slow Flash once per second	Wireless connection
	Flashing every 0.4 seconds	WPS is connecting
	Flashing every 0.2 seconds	EZLink takes effect
	Flashing every 0.1 seconds	SoftAP is started
	Constant for 3 secondsone time	Reset to take effect

1.5 Hardware Installation

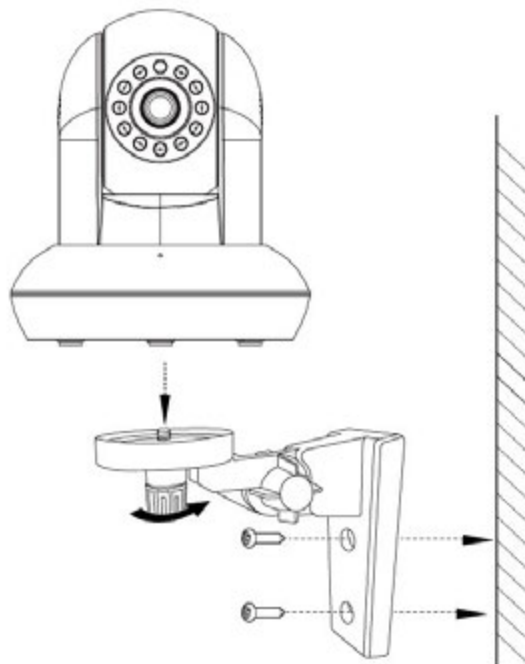

Step 1: Screw the mount on the wall with the two screws Provided.

Step2: Loosen the thumb screws to adjust the mount to the desired position. Once the position is set, tighten the screws securely.

2 Access the IP Camera

2.1 Hardware Connection & Software Installation

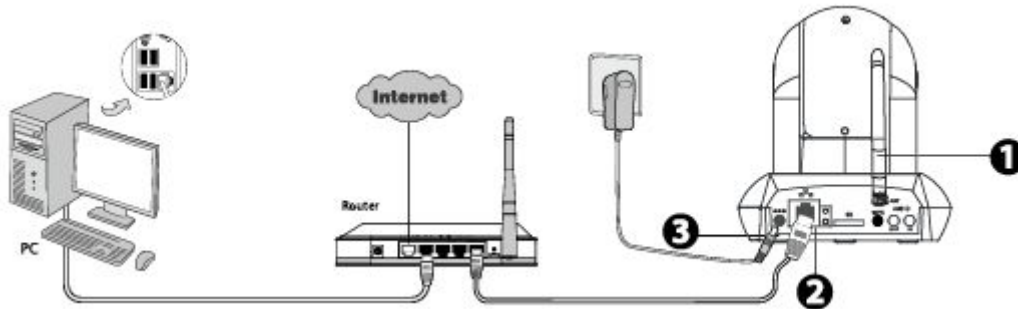

1. Mount the antenna and make it stand vertically.
2. Connect the camera to the LAN network (Router or Switch) via network cable.
3. Connect the power adapter to the camera.
4. Insert the CD into the CD drive of your computer.
5. Go to the folder "IP Camera Search Tool" and find the folder "For Windows OS" or "For Mac OS". Copy and paste the IP camera tool file to your computer, or drag it onto your Desktop.



Shortcut icon for Windows OS



Shortcut icon for Mac OS

Notes:

- If your computer (Windows OS) supports autorun function, you can find the corresponding file in the opened control panel.
- If your computer doesn't have CD drive, you can download the IP camera tool from our website for free.

2.2 Access the Camera in LAN

The camera supports HTTP and HTTPS protocols, you can access the camera in two ways.

(1) [http:// LAN IP + HTTP Port NO.](http://LAN IP + HTTP Port NO.)

The default HTTP port NO. is 88. Double click the IP Camera Tool icon to run, and it should find the camera's IP address automatically after you plug in the network cable.

Camera name	IP Address	Device ID	Device type
IPCAM	Http://192.168.11.220:88	00626E4D8A55	H

Double click the IP address of the camera; the camera login page should be open in your default browser.

(2) https:// LAN IP + HTTPS Port NO.

The default HTTPS port NO. is 443. You can use the URL to access the camera: https:// LAN IP + HTTPS port NO.

Go to **Settings - Network - Port** panel, you can see and change the HTTP and HTTPS port NO.

Save Refresh	
HTTP Port	88
HTTPS Port	443
ONVIF Port	65533

NOTE:

When logging in for the first time, you will need to download and install the add-on.

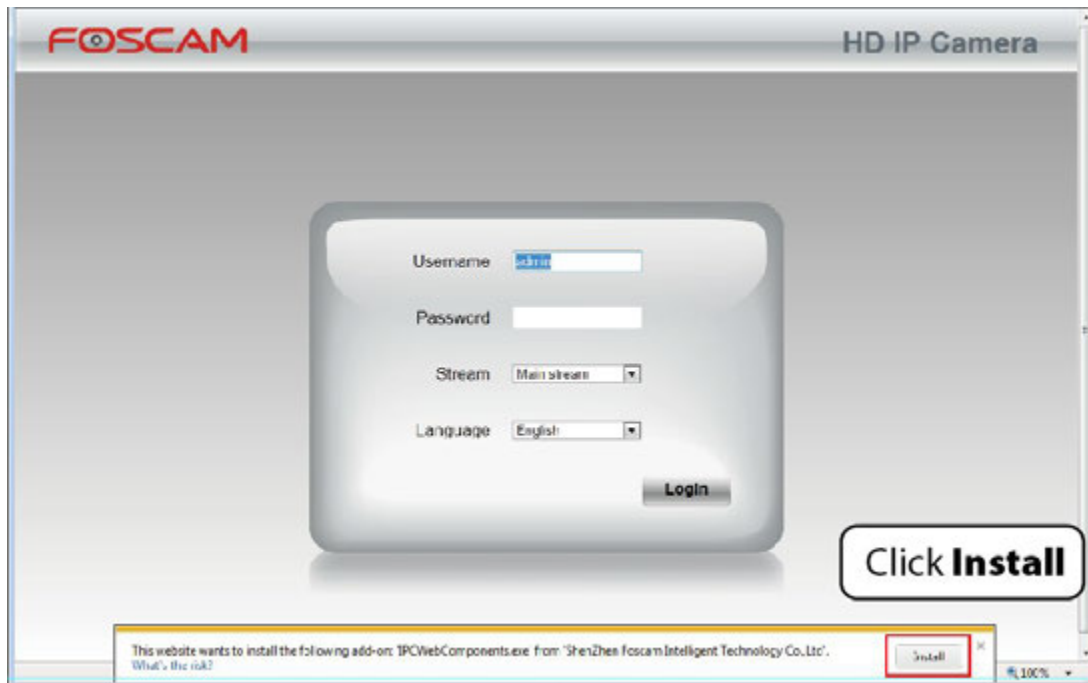

2.3 Access the Camera in WAN

2.3.1 Static IP Addresses

Users with static IP addresses do not need to set DDNS service settings for remote access. After you have finished connecting the camera using the LAN IP address and port forwarding, you can access the camera directly from Internet using the WAN IP address and port number.

How to Obtain the WAN IP address from a public website ?

To obtain your WAN IP address, enter the following URL in your browser: <http://www.whatismyip.com>. Your current WAN IP will be shown on the webpage.



2.3.2 Remote Access

If you want to access your camera by web browser outside of your LAN, you need to configure following configurations.

1. Choose “Settings” on the top of the camera web page, then go to the “Network > IP Configuration” section on the left side of the screen, then uncheck the Obtain IP DHCP.

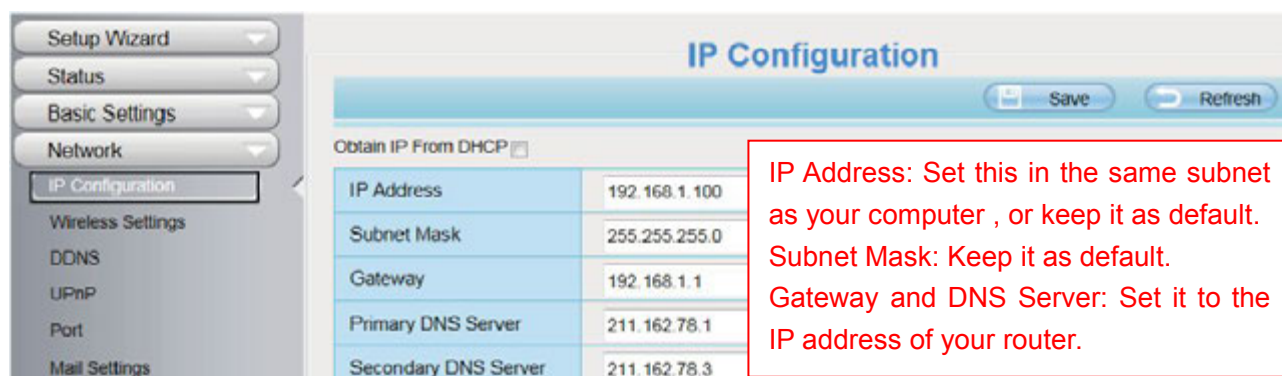

2. Enable UPnP and DDNS in the camera's settings page. We recommend you to use the DDNS by factory default.

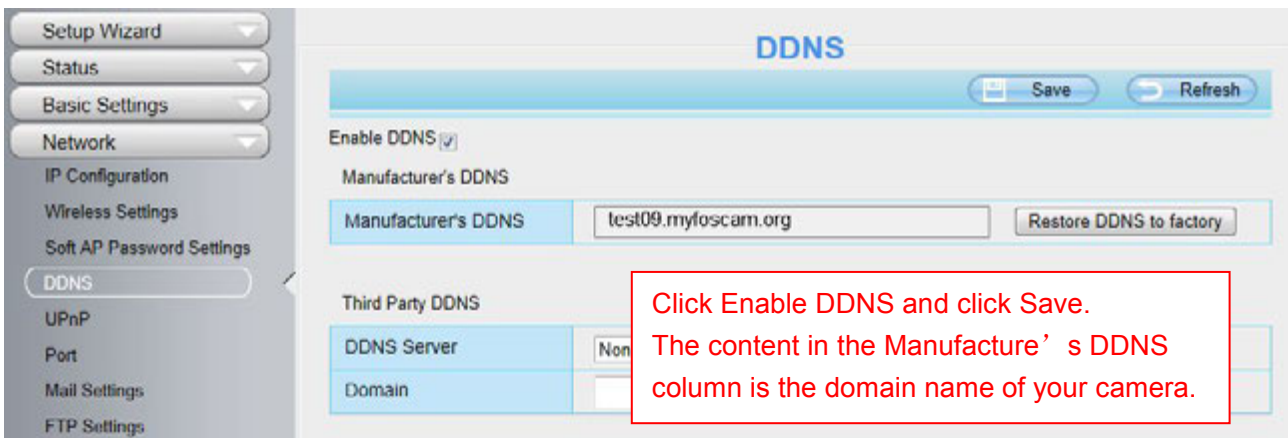
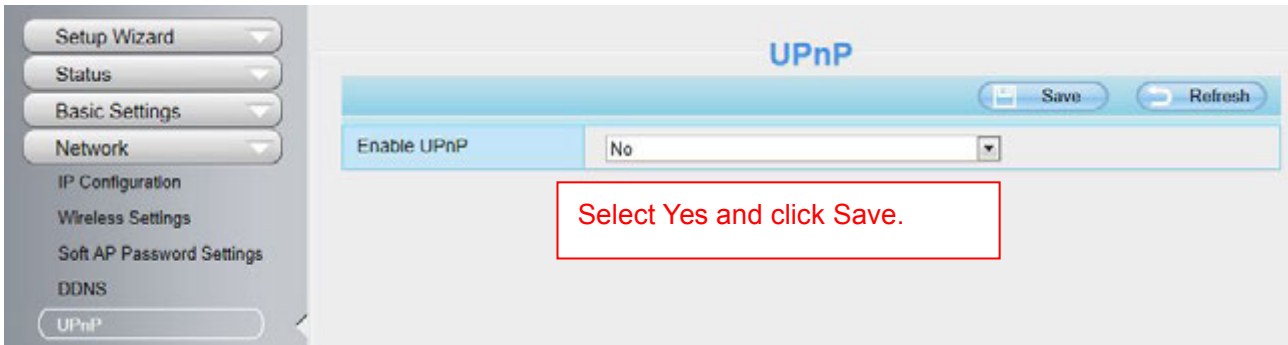

3. You can see the port of your camera here. If you want to set Remote Access for several cameras on the same network, you will need to change the HTTPS port for each camera.

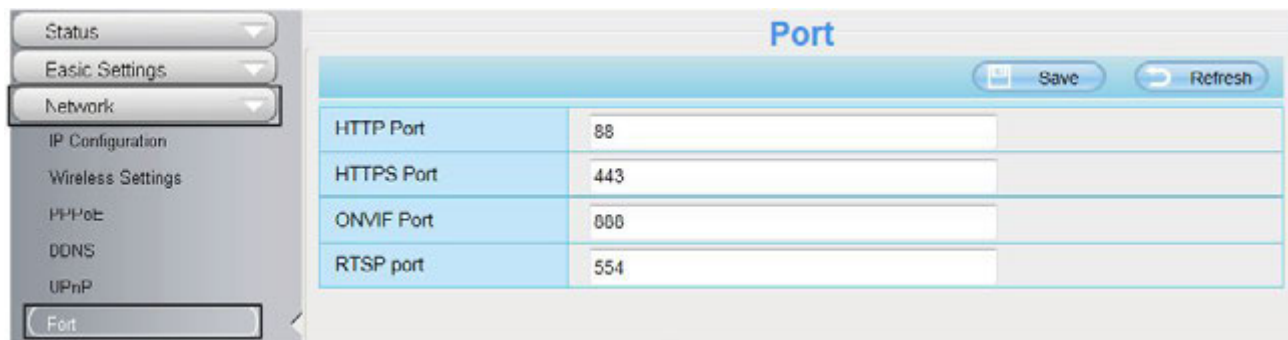

4. If the UPnP of the router has been enable, you do not need to perform following steps. Otherwise, you need to select one of the following methods to configure port forwarding on your router. For these steps, we will be using the TP-LINK brand wireless router as an example.

- **If there is a UPnP function in your router:**

Choose "Forwarding > UPnP", make sure that the Current UPnP Status is Enabled.

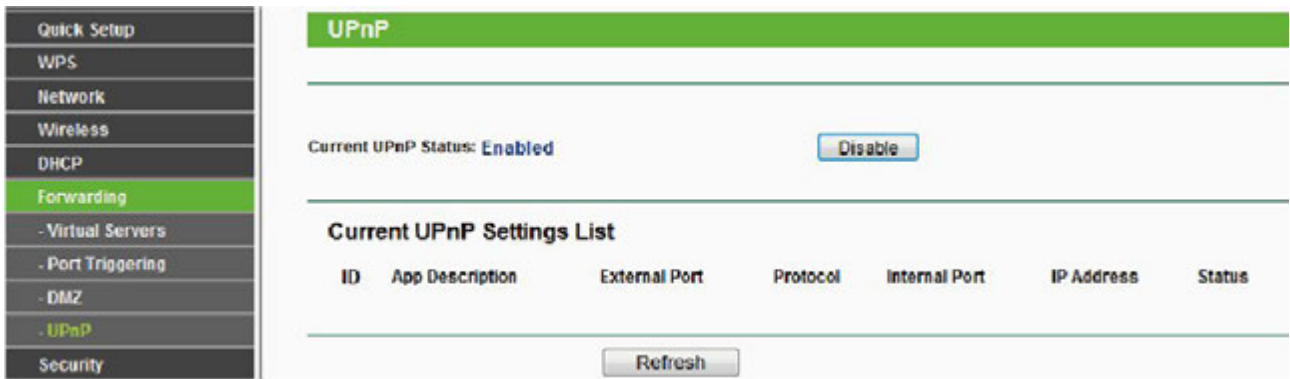

● **If there is no UPnP function in your router:**

You need to manually add port(HTTPS port) forwarding, refer to the following steps. You need go to the “Forwarding > Virtual Servers” panel for setup.

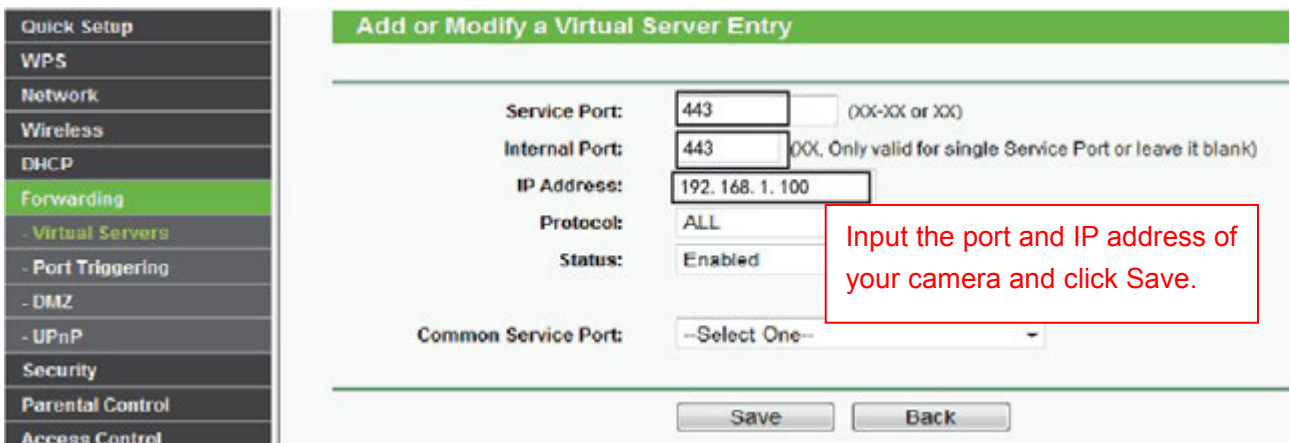

5. Now you can access your IP camera by https://domain name: HTTPS port via the Internet.

2.4 Using the VLC player

The camera supports RTSP streaming, here you can view the camera by VLC player.

RTSP URL [rtsp:// \[user name\]:\[password\]@IP:port number/videosream](rtsp://[user name]:[password]@IP:port number/videosream)

The part in the square brackets can be omitted.

user name & password: The user name and password to access the camera. This part can be omitted.

IP: WAN or LAN IP address.

Port number : If there is the RTSP port number on the Port page, you must only use RTSP port number. otherwise, you must only use http port number.

Video stream: Three modes are supported: video Main, video Sub and audio. Video Sub is a better choice in bad network condition. If you select audio, you can only hear sound without seeing picture.

For example:

IP: 192.168.1.11

Port number: 88

User name: admin

Password: 123

Enter either one of the following four URLs in the VLC

1. rtsp://admin:123@192.168.1.11:88/videoMain
2. rtsp:// @192.168.1.11:88/videoMain
3. rtsp://:123@192.168.1.11:88/videoMain
4. rtsp://admin@192.168.1.11:88/videoMain

Open the VLC, and go to “Media”--“Open Network Stream” option, then enter the URL in VLC.

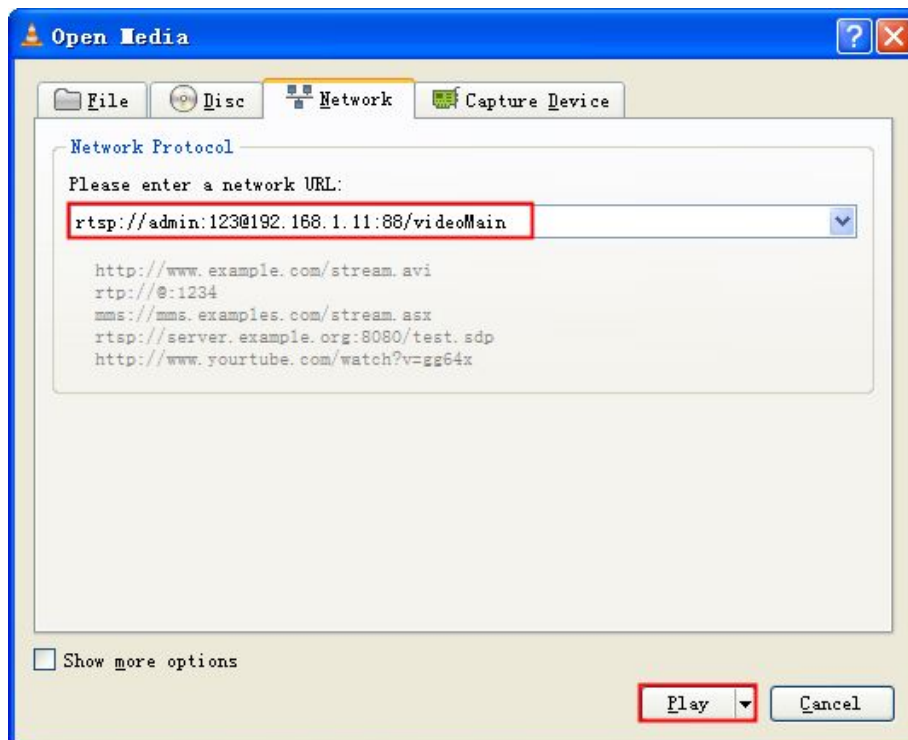
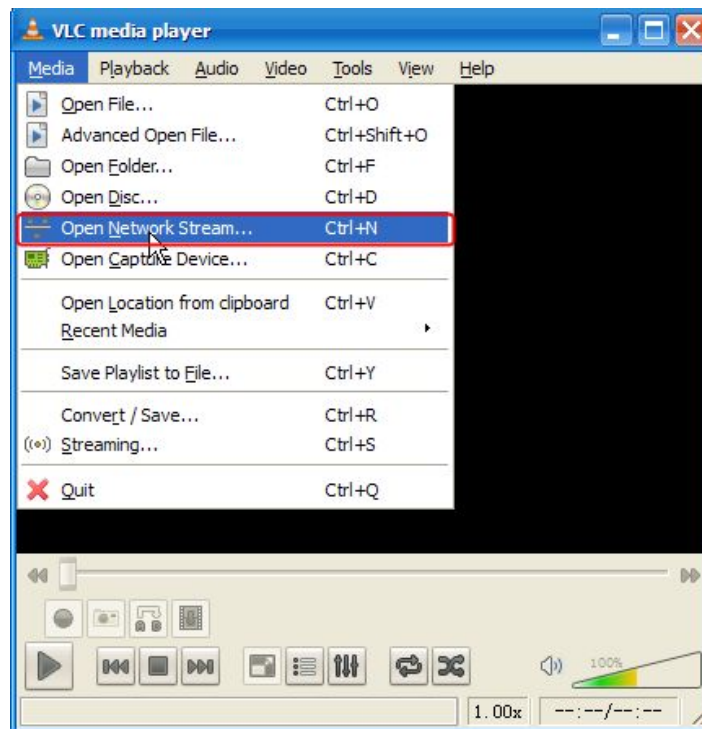

Sometimes you may need to enter the user name and password for another time. Click OK and you can see the real-time preview.

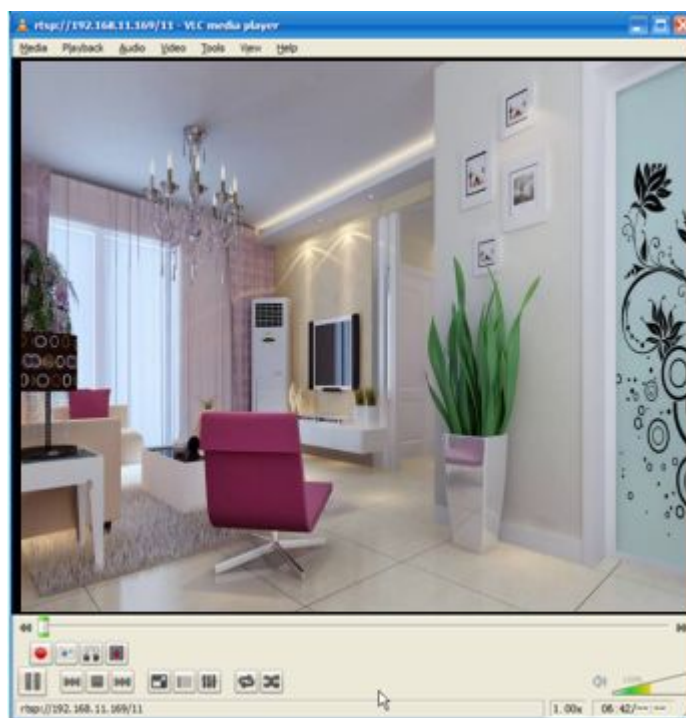

If you cannot play the video in the VLC player, please check the port mapping. You can read Quick Installation Guide about how to configure port forwarding.

NOTE:

If you modify the camera's username or password, you had better reboot the camera to apply the new username and password in authentication in the VLC.

2.5 IP camera connection to the server

Device supports ONVIF 2.2.1 protocol, You can easily access NVR with ONVIF or server with ONVIF.

3 Surveillance Software GUI

Please refer to the section 2.1 if you install the camera for the first time. You can start to learn about software operation after finish quick installation.

3.1 login Window

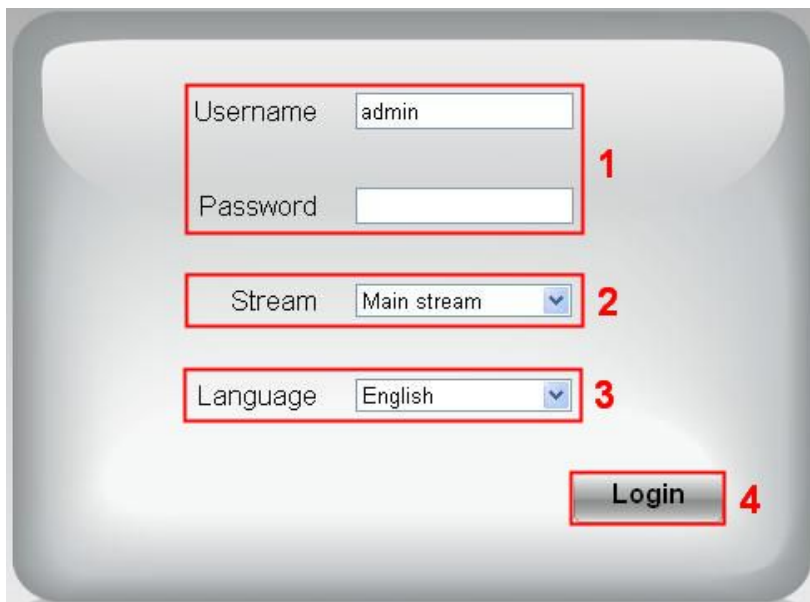

Section1 Enter the Username and password

The default administrator username is “admin” with no password, please change the password the first time you use and prevent unauthorized users login the camera.

Section2 Stream

The camera supports two stream modes: Main stream and sub stream. Select Main stream if you want to access the camera from LAN and sub stream will be better if you want to access the camera from Internet.

Note:

Select sub stream to ensure a more fluent video under narrow network bandwidth.

Section3 Select the language

You click on the language dropdown list to select language.

Section4 login the camera

Click “login” button.

NOTE:

When setting up your camera for the first time, it will request that you modify the default username and/or password if both are still set to default. Input the new username and password, click "Modify" to complete the modification. You will now use the new username and password to login to the camera in the future.

Username

New username

New password

Security Level

Confirm the password

3.2 Setup Wizard

You will go to “Setup Wizard” automatically after your first-login, where you can set the basic parameters of camera, such as camera name, camera time, wireless settings, IP configuration.

Setup Wizard

Setup Wizard - Start

Follow the guide to set your camera, click "Next" to start.

Please click the menu on the left for more settings.

Device Name: You could give name for your camera.

Setup Wizard

Step 1 of 4 - Camera Name

Camera Name

The maximum Device Name length is 20, support English, numbers, letters and symbols

System Time: Select the time zone you need to set the date, time, format and so on.

Setup Wizard

Step 2 of 4 - Camera Time

Time Zone: (GMT) Greenwich mean time; London, Lisbon, ▼

Sync with NTP server

NTP Server: time.nist.gov ▼

PC Time: 2014-1-1 12:17:29 PM

Date Format: YYYY-MM-DD ▼

Time Format: 12-hour ▼

use DST

Ahead Of Time: 0 Minute

Wireless networks: Click “Scan”, find the SSID of your wireless router, select and enter the password.

Setup Wizard

Step 3 of 4 - Wireless Settings

Wireless Network List			1
SSID(Network Name)	Encryption	Quality	<input style="border: 2px solid red;" type="button" value="Scan"/>
Tenda_373678	WPA/WPA2	📶	3
dlink-chenchen2.4G	WPA/WPA2	📶	
TP_LINK_TEST	WPA2	📶	
FOSCAM-docdev	WPA/WPA2	📶	

SSID	FOSCAM-docdev
Encryption	WPA/WPA2 ▼
Password	●●●●●●●●

The maximum password length is 63, including numbers, letters and symbols

IP: Set IP address of the camera. You could obtain an IP automatically or set the IP address according to your needs.

Setup Wizard

Step 4 of 4 - IP Configuration

Obtain IP From DHCP

IP Address	192.168.1.101
Subnet Mask	255.255.255.0
Gateway	0.0.0.0
Primary DNS Server	0.0.0.0
Secondary DNS Server	0.0.0.0

Note: Once you save your settings, the camera will restart.

3.3 Surveillance Window

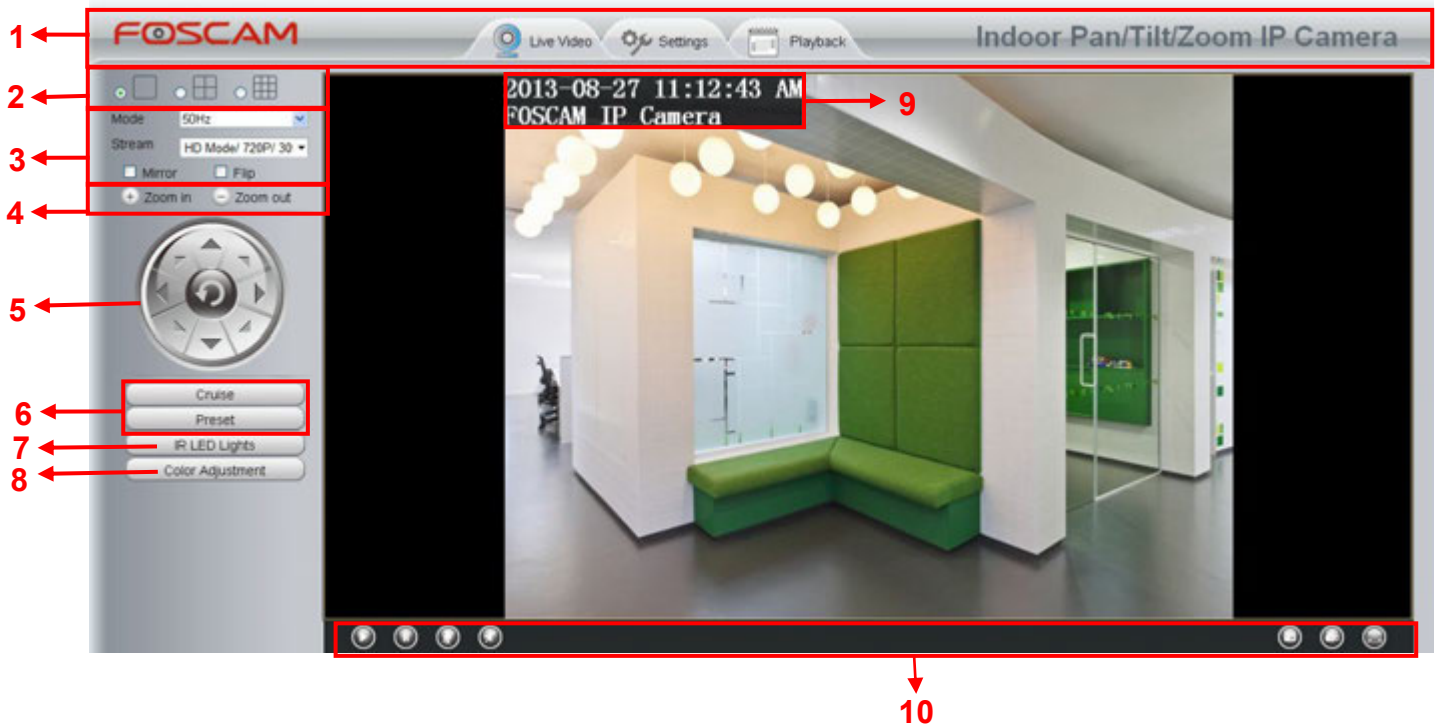

Section 1 FOSCAM Logo/ Live Video / Settings/Playback buttons

FOSCAM: FOSCAM LOGO

LiveVideo: Path to surveillance window. Click this button to go back to the surveillance window

Settings: Path to Administrator Control Panel, Click it, to go to Administrator Control Panel and do advanced settings.



: Click this button to go back to the Playback panel to view the stored audio files stored in the SD Card.

Section 2 Multi-Device Window



The firmware inside the camera supports up to 9 cameras being monitored at the same time. You can add other cameras in multi-device setting (read chapter 4.3.4).

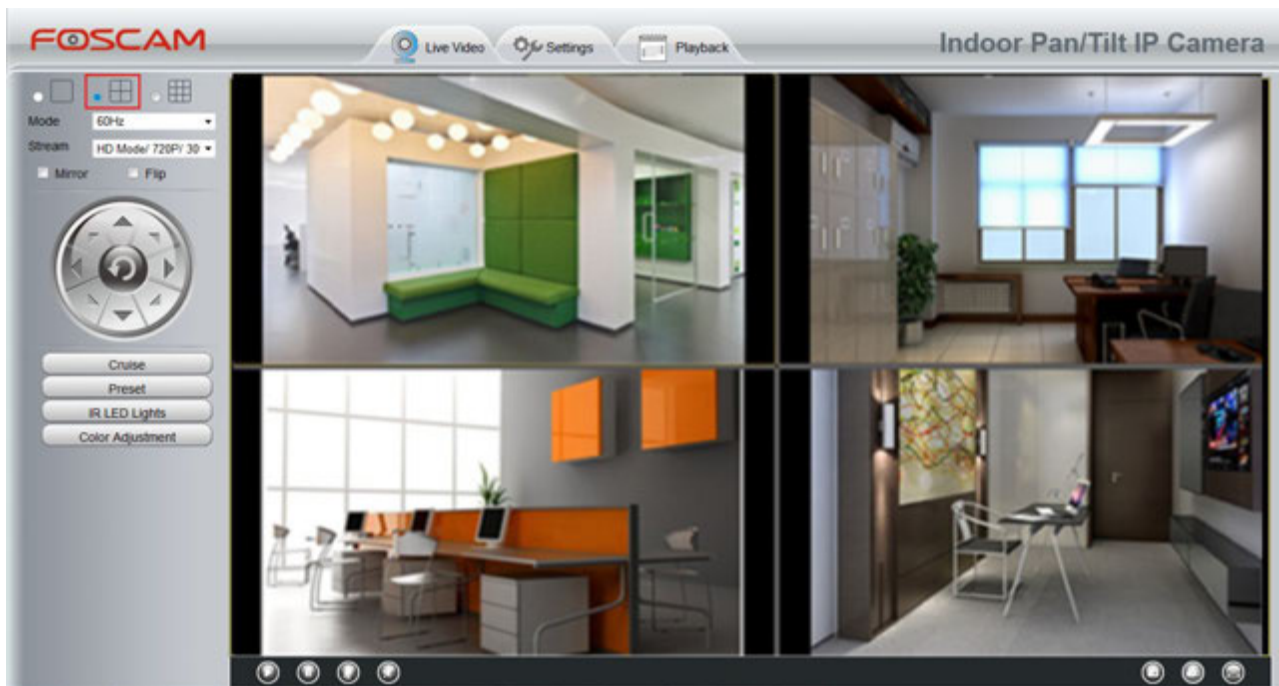

Section 3 Mode/ Stream / Mirror/ Flip buttons

Mode

- 1) 50HZ -----Indoor surveillance (Region: Europe, China)
- 2) 60HZ -----Indoor surveillance (Region: USA, Canada)
- 3) Outdoor-----Outdoor surveillance

Stream

The default stream supports multiple modes, For example: HD Mode/720P/30fps/2M meanings: Stream type / Resolution / Maximum frame rate/ Bit rate. (Different models support different specific mode.)

1) Stream type : It is used to identify the stream type.

2) Resolution

The bigger the resolution, the better of the image quality is. If you are accessing the camera via internet and want to get more fluent video streaming, please select resolution VGA.

3) Maximum frame rate

The maximum frame rate is 30 fps. You should lower frame rate when the bandwidth is limited. Normally, when the frame rate above 15, you can achieve fluently video. The maximum frame rate for each model is different.

4) Bit rate

Generally speaking, the larger the bit rate is, the clearer video will become. But the bit rate configuration should combine well with the network bandwidth. When the bandwidth is very narrow, and bit rate is large, that will lead to video can not play well.

You can reset the stream type on **Settings-> Video-> Video Settings** panel.

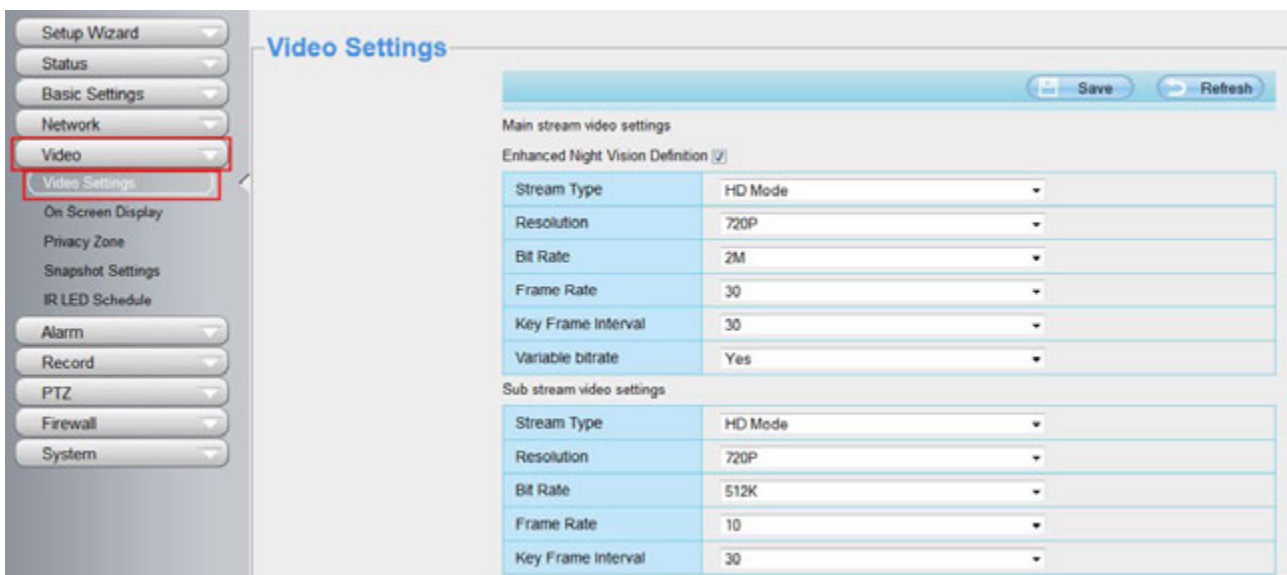

After changing, please re-login the camera and you can see the modification.

Section 4 Zoom Control

+ Zoom in Zoom in the camera's lens.

- Zoom out Zoom out the camera' lens.

You can adjust the speed of the lens' zoom in **Settings--PTZ--Pan & Tilt Speed--Zoom speed** panel.

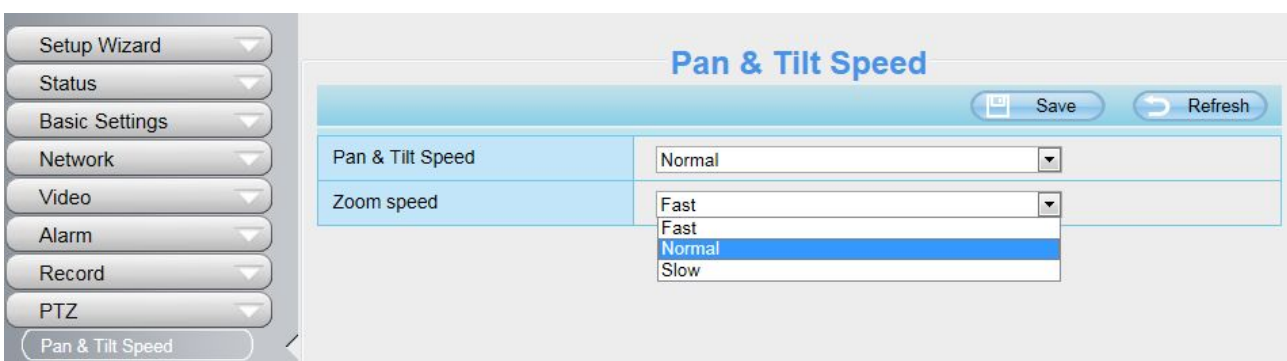

NOTE :

Except for FI9826P, other Cameras don't support this function.

Section 5 Pan/Tilt Control



- 1----- Up control button,
- 2-----Down control button,
- 3-----Left control button,
- 4-----Right control button,
- 5----- Up-Left control button
- 6----- Up-Right control button
- 7----- Down-Left control button
- 8----- Down-Right control button



Click this button and go to center

Section 6 Cruise / Preset settings

Cruise Settings



The default cruise tracks have two types: Vertical and Horizontal.

- Vertical: The camera will rotate from up to down.
- Horizontal: The camera will rotate from left to right.



: Start cruise.



: Stop cruise.

If you want to define or change the cruise trace, please go to **Settings** → **PTZ Preset Settings** panel.

How to do cruise?

Firstly: Select one track in the track dropdown list.



Secondly: Click Start cruise button, the camera will cruise following the predefined path.

Thirdly: Click stop button and finish cruising.

Preset settings



IPCam supports 16 preset positions, which is considered enough for DIY home & small business surveillance market

The default preset position is Topmost, Bottom most, Left most, right most, you can add other preset positions.



Add Click this icon to save the position you need the camera to remember



Delete Select one preset position and click this button to delete it.



GO Select one preset position in the preset drop-down list and click Go to make the camera move the preset position

How to do preset position?

Firstly, move the camera and stop at a desired place where you want make preset position.

Secondly, click  button and enter a descriptive name for the preset position. The preset position cannot contain special characters. Then click OK to save it. If you want to reset the preset position, click Cancel.

After that, you can move the camera and stop at another place, and set another preset position. You can do all the 16 preset positions with this method.

If you want to see one preset position you have set, only select the preset position name from the preset drop-down list, and click go  button, the camera will go to the preset position.

Section 7 IR LED Lights

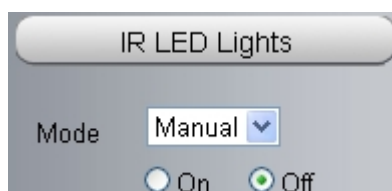

Click Infra led and there are three modes to adjust the infrared led: Auto, Manual and Schedule.

Auto: Select it and the camera will adjust the infra led (on or off) automatically.

Manual: Select it and you can turn on or turn off the infra led manually.

Schedule: Select it and the IR led light will be off at the schedule period. If you want to define or change the IR led lights schedule time, please go to **Settings--->Video---> IR LED Schedule** page.

Section 8 Image quality settings

In this page, you can tune Hue, Brightness, Contrast, Saturation, and Sharpness to get higher quality.

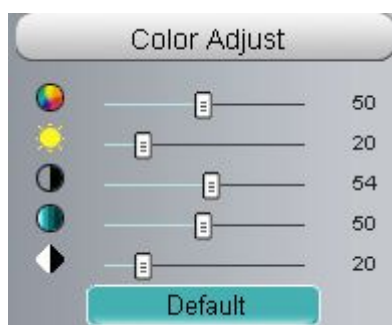

Section 9 OSD

If you have added time and camera name in the video, you can see it in the live window.

Go to **Settings ---Basic settings---Camera name** panel, and you can change another device name. The default device name is anonymous.

Go to **Settings ---Basic settings---Camera time** panel and adjust the device time.

Go to **Settings ---Video---On Screen Display** panel, you can add or no add OSD.

Section 10 Play/Stop/ Talk/Audio/ Snap/ Record/ Full screen button



1----- Play Click it to play the video of the camera

2----- Stop Click it to stop the video of the camera

3----- Talk Click the button and the icon will become to , then talk to the microphone that connected with PC, people around the camera can here your voice. Click the icon again and stop talking.

4----- Audio Click this icon, the icon will become to , you can hear the sound around the camera by the earphone or speakers that connected with PC.

5----- Snapshot Click it to make snapshot and it pop-up a window which picture you snapshot, right

click in the window and save the picture to anywhere you want.

6----- Record Click the icon  and the camera start recording, you can see a green dot in the live window. Click again and stop recording. The default storage path is C:\IPCamRecord. You can change the storage path: Go to Settings- >Record->Storage Location panel.

7----- Full Screen Click it to make full-screen, or you can double click the surveillance screen to make full-screen. Double click again and exit full-screen.

Onscreen Mouse Control

Right click the mouse and you can adjust the screen ration, full screen and Zoom up.

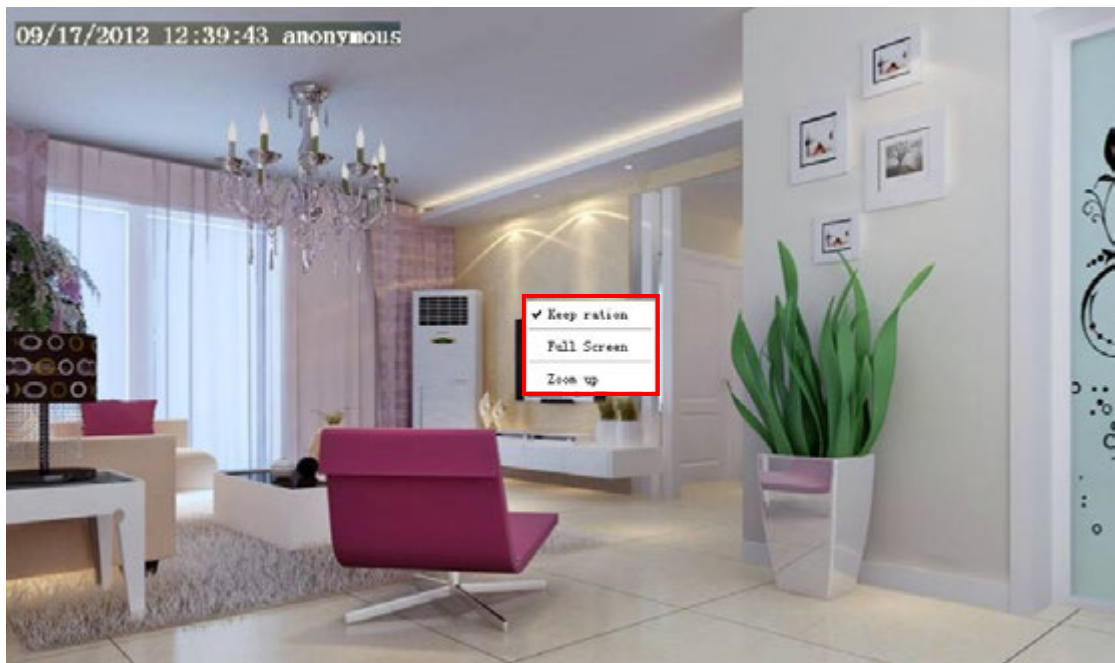

Keep ration: Select it and the camera will adjust the size of live window based on the the computer monitor automatically. Sometimes there is a black border around the video, please select Keep ration to get a better visual quality .

Full Screen: Select it and Click it to make full-screen, press ESC and exit full-screen.

Zoom up: Select it and you can see a bigger screen than before.

First Method: Here is a convenient and fast solution to Zoom up/down screen by Clicking Video Screen and adjusting Mouse pulley, or by press the CTRL key and click the mouse left button.

Second Method: Click it and the live view will be digital zoomed up, then click Zoom Down and the live view back to original size.

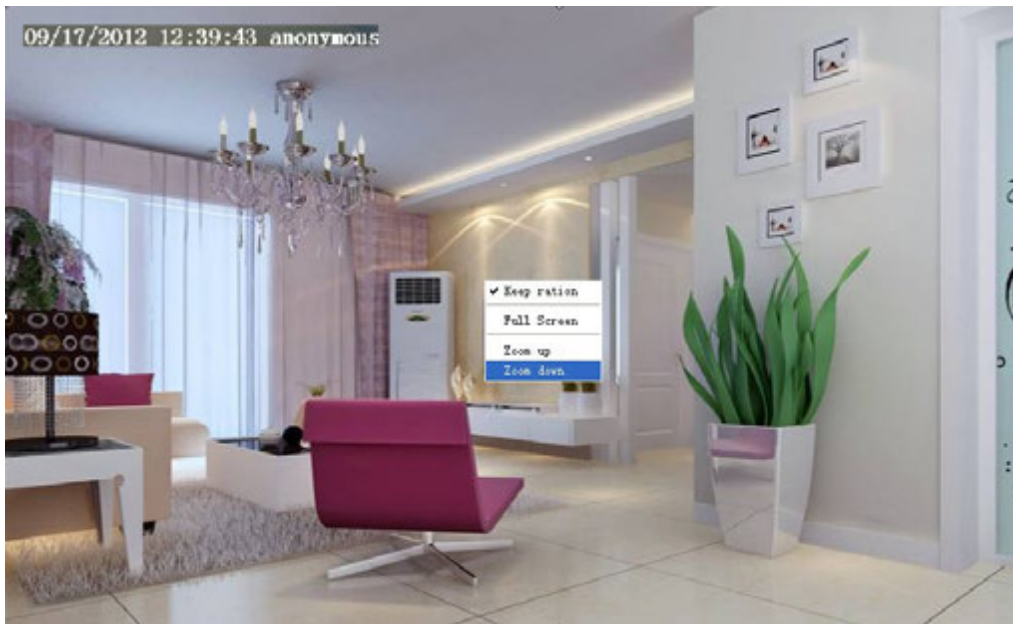

When you select the Full Screen, then click right mouse, there is a Screen PTZ button.

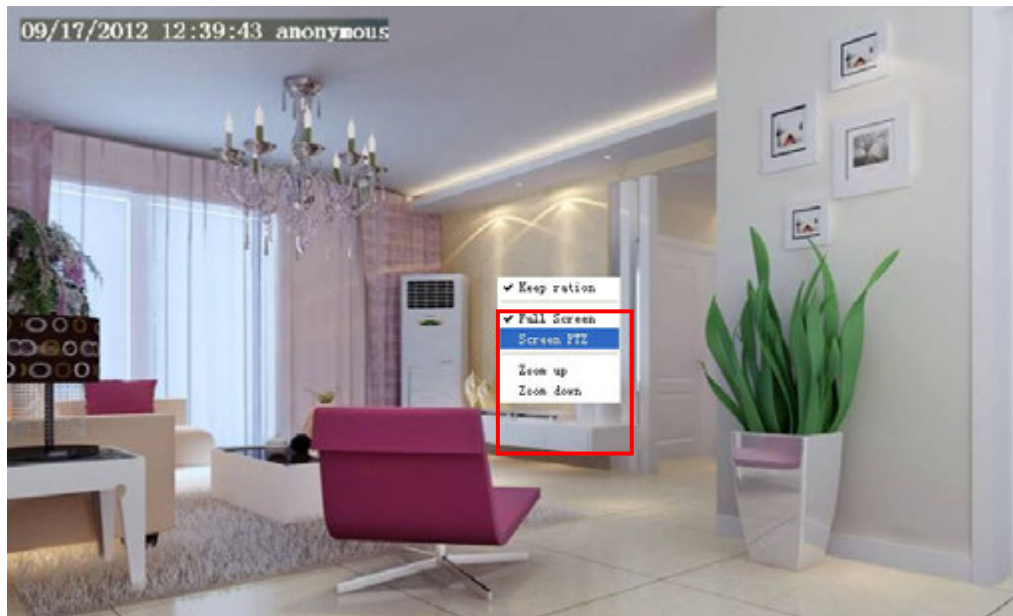

Click the **Screen PTZ** button and put the mouse on the screen to indicate the camera move direction you prefer, press the left mouse, the camera will move to the corresponding direction. Loosen the mouse and stop moving. Press Esc button or double click right mouse and cancel the function.

NOTE: For Mac OS, the plugin cannot support Onscreen Mouse Control, so you cannot allow to use it.

4 Advanced Camera Settings

Click the button “**Settings**”, goes to Administrator Control Panel to make advanced camera settings.

4.1 Setup Wizard

Please go to section 3.2 to find the way to set it.

4.2 Status

Status contains four columns: Device Information, Device Status, Session Status and Log, it will show you various information about your camera.

4.2.1 Device Information



Device Information	
Camera Model	FI9826P
Camera Name	FI9826P
Camera ID	C4D655397F42
Camera Time	2014/10/08 12:07:43
System Firmware Version	1.5.2.11
Application Firmware Version	2.21.1.127
Plug-In Version	3.0.0.6

Camera Model: The camera model NO.

Camera Name: The Device Name is a unique name that you can give to your device to help you identify it. Click **Basic Settings** and go to **Camera name** panel where you can change your camera name. The default device name is anonymous.

Camera ID: Display the wired MAC address of your camera.

Camera Time: The system time of the device. Click **Basic Settings** and go to **Camera time** panel and adjust the time.

System Firmware Version: Display the System Firmware version of your camera.

App Firmware Version: Display the application firmware version of your camera.

Plug-In Version: Display the plug-in version of your camera.

4.2.2 Device Status

On this page you can see device status such as Alarm status/ Record Status ,DDNS status ,WIFI status and so on.

Device Status	
Refresh	
Alarm Status	Disabled
Recording Status	Not Recording
SD Card Status	No SD card
SD Card Free Space	0KB
SD Card Total Space	0KB
NTP Status	Failed
DDNS Status	Disabled
UPnP Status	Disabled
WiFi Status	Not connected
IR LED Status	Off

4.2.3 Session Status

Session status will display who and which IP is visiting the camera now.

Session Status	
Refresh	
Username	IP Address
1	192.168.1.101

4.2.4 Log

The log record shows who and which IP address accessed or logout the camera.

Pages:83				
NO.	Time	User	IP	Log
1	2012-09-18 02:11:45			
2	2012-09-18 01:48:56			
3	2012-09-18 01:29:51	admin	192.168.1.102	Log out
4	2012-09-18 01:27:54	admin	218.17.160.187	Log out
5	2012-09-18 01:26:21	admin	192.168.1.100	Log out
6	2012-09-18 01:25:42	admin	218.17.160.187	Login
7	2012-09-18 01:25:15	admin	192.168.1.102	Login
8	2012-09-18 01:25:13	admin	192.168.1.102	Log out
9	2012-09-18 01:24:46	admin	192.168.1.100	Login
10	2012-09-18 01:21:44	admin	192.168.1.102	Login

Reboot the camera and clear the log records.

4.3 Basic Settings

This section allows you to configure your camera's Name, Time, Mail, User account and Multi-Device.

4.3.1 Camera Name

You can define a name for your camera here such as apple. Click Save to save your changes. The alias name cannot contain special characters.

Camera Name

Save Refresh

Camera Name	<input style="width: 90%;" type="text" value="F19826P"/> <p style="font-size: small; margin-top: 5px;">The maximum Device Name length is 20, support English, numbers, letters and symbols</p>
-------------	--

4.3.2 Camera Time

This section allows you to configure the settings of the internal system clocks for your camera.

Camera Time

Time Zone	(GMT) Greenwich mean time; London, Lisbon, ▾
Sync with NTP server <input type="checkbox"/>	
NTP Server	time.nist.gov ▾
PC Time	<div style="display: flex; align-items: center; gap: 10px;"> <input type="text" value="2014-10-8"/> 12 ▾ : 11 ▾ : 22 ▾ PM ▾ </div> <div style="text-align: center; margin-top: 5px;"> <input type="button" value="Sync with PC"/> </div>
Date Format	YYYY-MM-DD ▾
Time Format	12-hour ▾
use DST <input checked="" type="checkbox"/>	
Ahead Of Time	0 ▾ Minute

Time Zone: Select the time zone for your region from the dropdown menu.

Sync with NTP server: Network Time Protocol will synchronize your camera with an Internet time server. Choose the one that is closest to your camera.

Sync with PC: Select this option to synchronize the date and time of the Network Camera with your computer.

Manually: The administrator can enter the date and time manually. Note select the date and time format.

use DST: Select the daylight saving time from the dropdown list.

Click **Save** button and submit your settings.

NOTE: If the power supply of camera is disconnect, you need set the camera's time again.

4.3.3 User Accounts

Here you can create users and set privilege, **visitor**, **operator** or **administrator**. The default user account is admin, with a blank password. You can enter the users accounts of visitor, operator and administrator Manually.

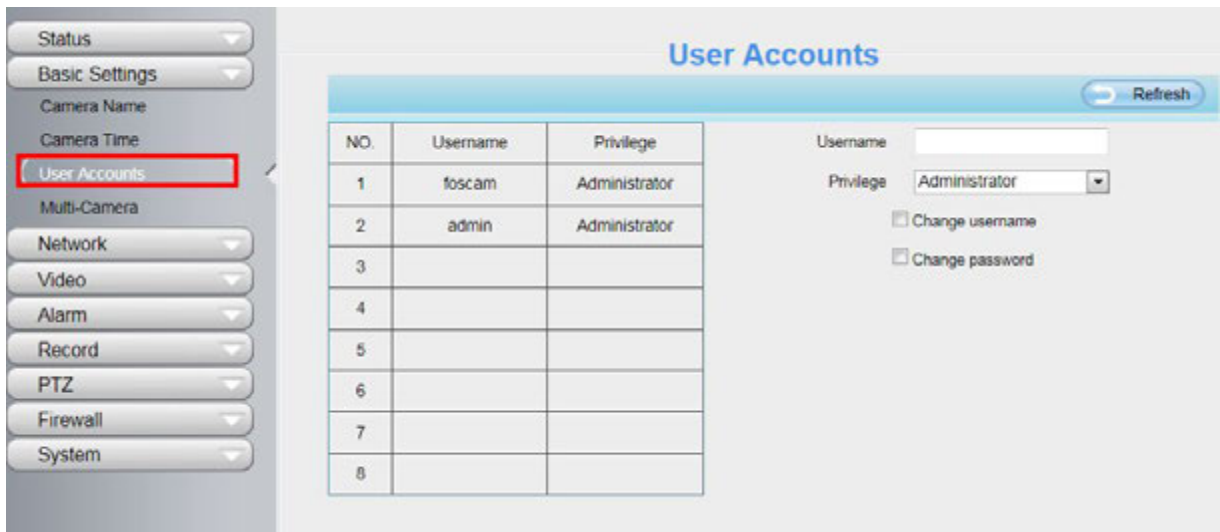

How to change the password?

Firstly, select the account which you want to change the password, then select “Change password”, enter the old password and the new password, lastly click modify to take effect.

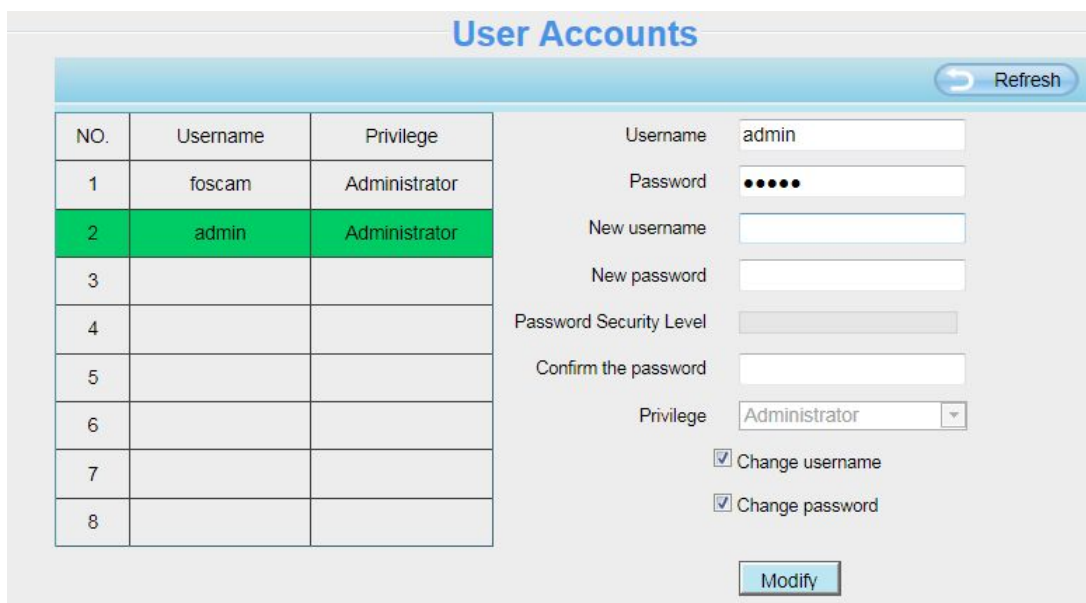

How to add account ?

Select one blank column, then enter the new user name, password and privilege, last click Add to take effect. You can see the new added account on the Account list.

User Accounts

Refresh

NO.	Username	Privilege
1	foscam	Administrator
2	admin	Administrator
3		
4		
5		
6		
7		
8		

Username:
 Password:
 Password Security Level: Low security level.
 Confirm the password:
 Privilege:

Change username
 Change password

Add

User Accounts

Refresh

NO.	Username	Privilege
1	foscam	Administrator
2	admin	Administrator
3	user	Administrator
4		
5		
6		
7		
8		

Username:
 Privilege:

Change username
 Change password

Delete

Delete : Select the account which you want to delete, then click Delete button to take effect.

NOTE: The default admin account cannot be deleted, but you can add other administrator users.

How to change the username ?

Firstly, select the account which you want to change the username, then select “Change username”, enter the new password, lastly click modify to take effect.

User Accounts

Refresh

NO.	Username	Privilege
1	1	Administrator
2	user	Administrator
3		
4		
5		
6		
7		
8		

Username:
 New username:
 Privilege:

Change username
 Change password

4.3.4 Multi-Camera

If you want to view multi-surveillance screens on one window, you need to login one camera, and set it as the main device, and do Multi-Device Settings, add other cameras to the first one camera. Before you do multi-cams settings, you need to assign different port such as 81, 82, 83, 84, 85, 86, 87, 88 to the cameras if there is 8 cams installed.

The firmware within the camera can support a maximum of 9 devices monitoring all at the same time. This page you can both add FOSCAM MJPEG and H.264 series cameras to the first camera and view multi-surveillance screen on one window.

Add cameras in LAN

In Multi-Device Settings page, you can see all devices searched in LAN. The 1st Device is the default one. You can add more cameras in the list in LAN for monitoring. The camera's software supports up to 9 IP Cameras online simultaneously. Click The 2nd Device and click the item in the Device List in LAN, the Alias, Host and Http Port will be filled in the boxes below automatically. Enter the correct username and password then click Add. Add more cameras in the same way.

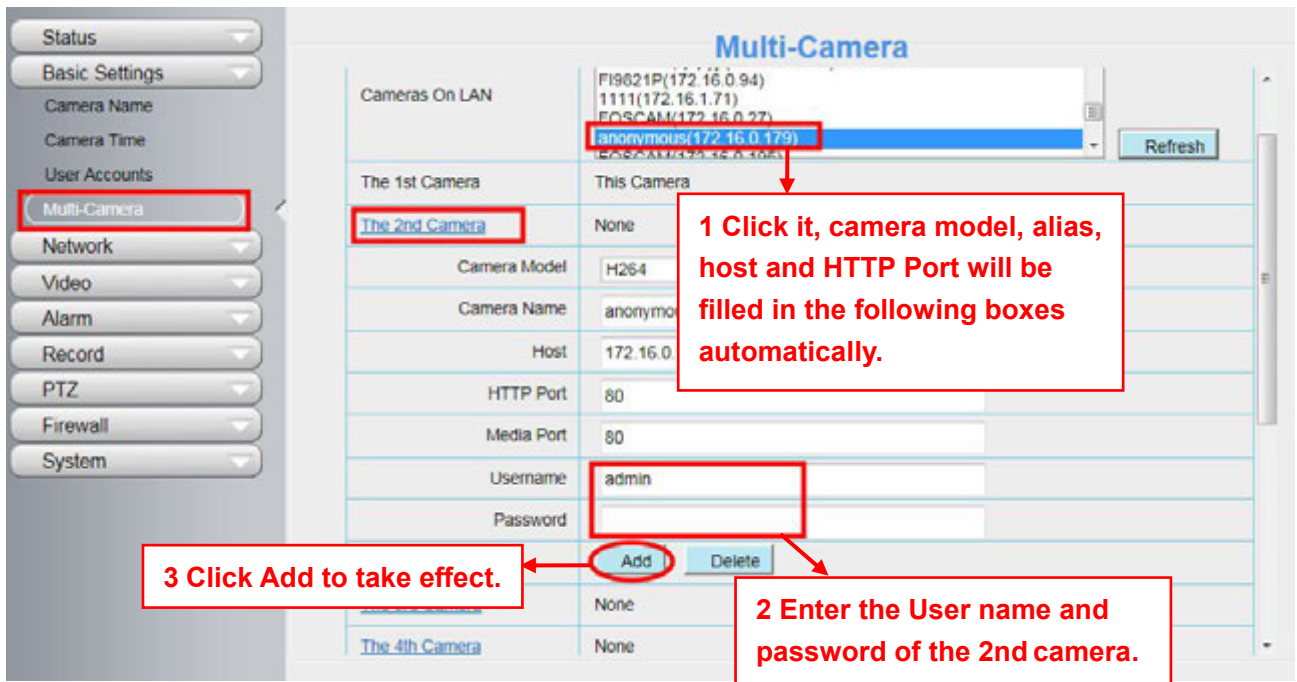

Camera Model: Our Company produces two series cameras: MJPEG and H.264. Here will show you which series the camera belongs to.

Cameras On LAN	FI9821P(172.16.0.94) 1111(172.16.1.71) FOSCAM(172.16.0.27) anonymous(172.16.0.179) FOSCAM(172.16.0.27)	Refresh
The 1st Camera	This Camera	
The 2nd Camera	anonymous(192.168.11.203)	
The 3rd Camera	FI9821W for ebuyer (192.168.11.241)	
The 4th Camera	anonymous(192.168.11.203)	
The 5th Camera	None	
The 6th Camera	None	
The 7th Camera	None	
The 8th Camera	None	
The 9th Camera	None	

Note: If you want to access your camera remotely, make sure you are able to access it seperately through a browser.

Back to **Surveillance Windows**, and click Four Windows option, you will see four cameras you added.

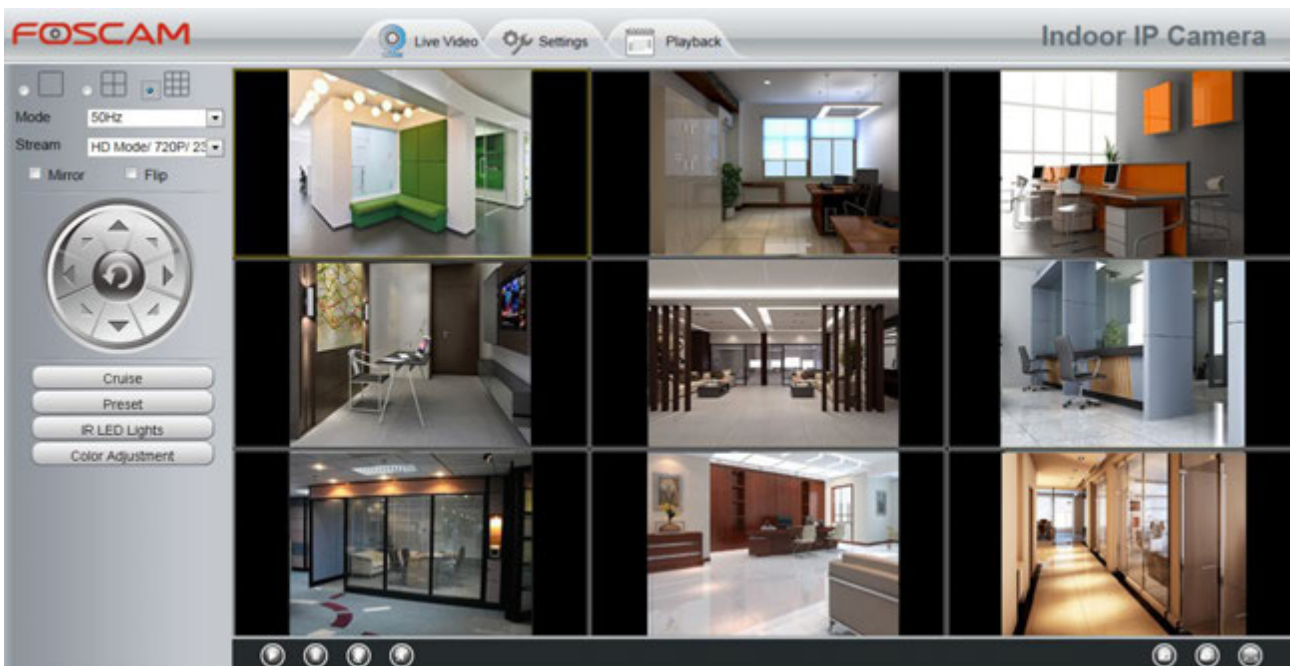
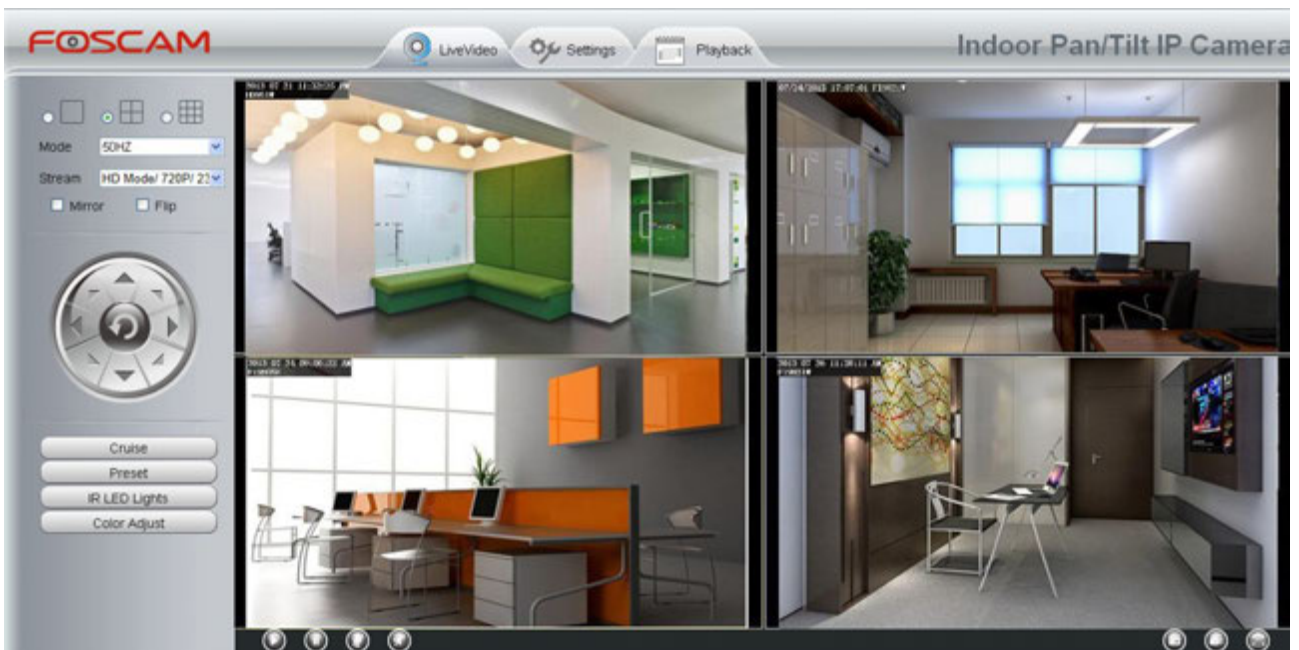

Add cameras in WAN

If you want to view all cameras via the internet(remote computer), you will need to add them using DDNS domain name. Firstly, make sure all of the cameras you added can be accessed through the internet.

(The way to configure DDNS is in chapter 4.4.4)

login to the first camera using a DDNS domain name and port.

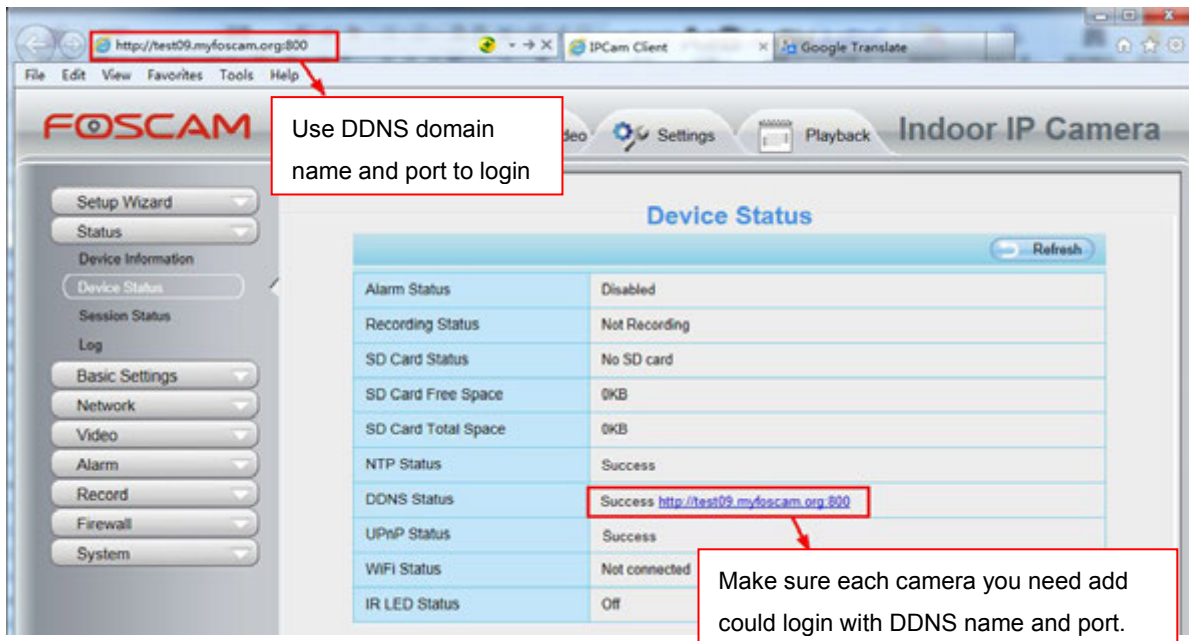

Click **Multi-Device Settings**. Choose **The 2nd Device**. Fill in the 2nd camera's name, DDNS domain name, port number. Enter user name and password and then choose Add.

The 1st Camera	This Camera
The 2nd Camera	F19821W(172.16.0.47)
Camera Model	H264 1
Camera Name	F19821W 2
Host	172.16.0.47
HTTP Port	88 3
Media Port	88
Username	admin
Password	<input type="password"/> 4
5 <input type="button" value="Add"/> <input type="button" value="Delete"/>	

1 ---- The camera model: MJ or H264.

2 ---- The 2nd camera's name

3 ---- Fill in the 2nd camera's DDNS host not LAN IP

NOTE: The MJ series have the same HTTP Port NO. and Media Port NO.

4 ---- Enter the 2nd camera's user name and password

5 ---- Click Add button and to take effect

NOTE: Here the Host must be entered as the second camera's DDNS domain name, not its LAN IP.

Cameras On LAN		Refresh
	anonymous(192.168.11.193) F19821W for ebuyer (192.168.11.241) anonymous(192.168.11.203) anonymous(192.168.11.243)	Refresh
The 1st Camera	This Camera	
The 2nd Camera	F19821W(172.16.0.47)	
The 3rd Camera	F19821W for ebuyer (192.168.11.241)	
The 4th Camera	anonymous(192.168.11.203)	
The 5th Camera	None	
The 6th Camera	None	
The 7th Camera	None	
The 8th Camera	None	
The 9th Camera	None	

Note: If you want to access your camera remotely, make sure you are able to access it separately through a browser.

Return to video window. You will see all of the cameras accessible through the internet. When you are away from home, you can use the first camera's DDNS domain name and port to view all the cameras via internet.

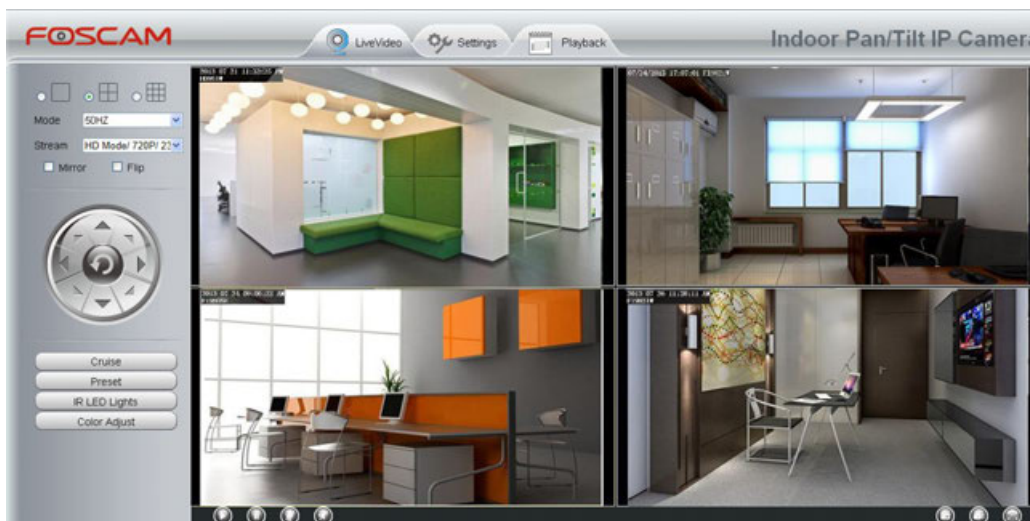

4.4 Network

This section will allow you to configure your camera's IP, PPPoE, DDNS, Wireless Settings, UPnP and Port.

4.4.1 IP Configuration

If you want to set a static IP for the camera, please go to **IP Configuration** page. Keep the camera in the same subnet of your router or computer.

Save Refresh

Obtain IP From DHCP

IP Address	192.168.0.109
Subnet Mask	255.255.255.0
Gateway	192.168.0.1
Primary DNS Server	192.168.0.1
Secondary DNS Server	202.96.134.133

Note: Once you save your settings, the camera will restart.

Changing settings here is the same as using the IP Camera Tool.

It is recommended that you use the subnet mask, gateway and DNS server from your locally attached PC. If you don't know the subnet mask, gateway and DNS server, you can check your computer's local area connection as follows:

Control Panel → **Network Connections** → **Local Area Connections** → **Choose Support** → **Details**

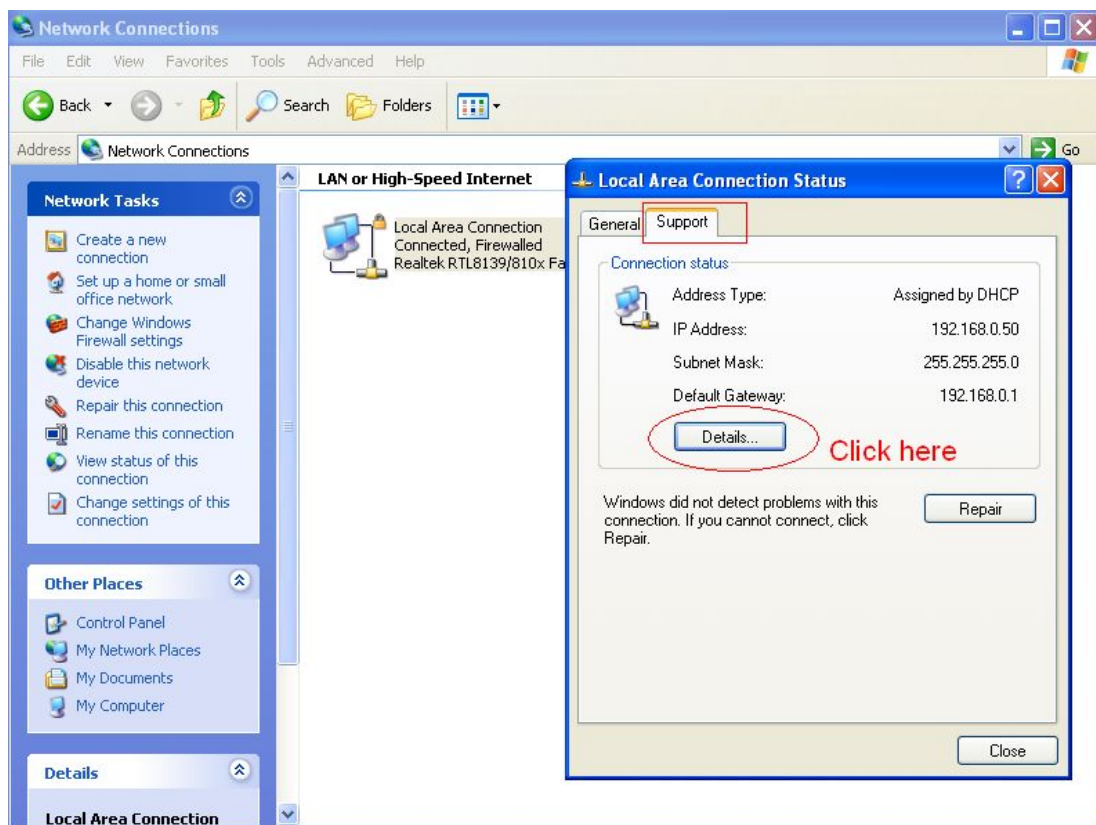

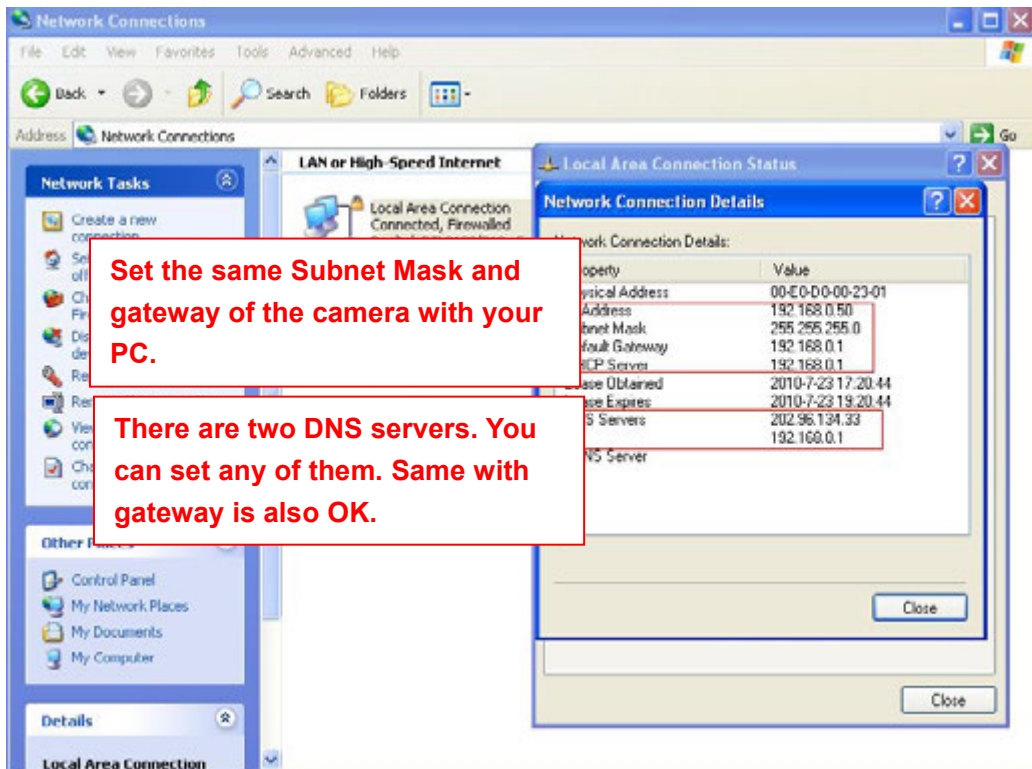

If you don't know the DNS server, you can use the same settings as the Default Gateway.

4.4.2 Wireless Settings

There are two ways of wireless connection: Manually configure the wireless connection and WPS.

Manually configure the wireless connection

Step 1: Choose "Settings" on the top of the camera interface, and go to the "Network" panel on the left side of the screen, then click "Wireless Settings."

Click the **Scan** button and the camera will detect all wireless networks around the area. It should also display your router in the list.



Step 2: Click the SSID (name of your router) in the list, the corresponding information related to your network, such as the name and the encryption, will be filled into the relevant fields automatically.

You will only need to fill in the password of your network. Make sure that the SSID, Encryption and the password you filled in are exactly the same for your router.

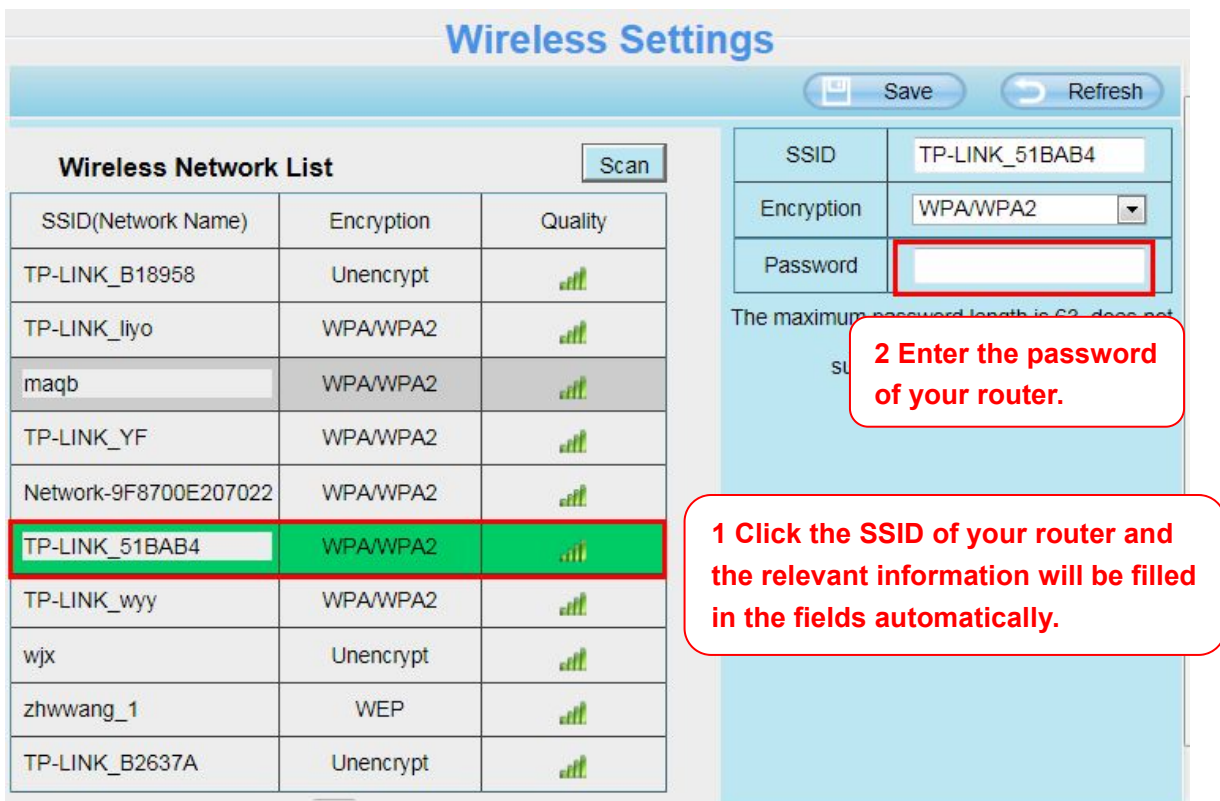

Step 3: Please click on the **Save** button after all settings have been entered and disconnect the network cable. Never shut down the power of the camera until the IP camera is able to connect to the wireless

network.

The LAN IP address will disappear on the window of IP Camera Tool when the camera is configuring a wireless connection. Wait about 1 minute, the camera should obtain a wireless connection, and the LAN IP of the camera will show again on the window of the IP Camera Tool. The IP address may have changed after the camera receives a wireless connection; we recommend setting a static local IP address if this IP address changes by right clicking the camera in IP Camera Tools, setting a static IP, and pushing OK.

Congratulations! You have set up the wireless connection of the camera successfully.

NOTE :

If you fail to make a wireless connection, please refer to your seller or contact us directly for assistance.

WPS (WI-FI Protected Set-up)

Before using WPS wireless connection, you need to:

- Make sure that your wireless router has the WPS function, and has been properly connected to the Internet.
- WPS button on the wireless router is typically located on the front panel or rear panel. TP-LINK router's WPS button is called QSS (Quick Security Setup).
- Make sure that the ethernet cable and the camera is disconnected.



- (1) Press and hold the WPS button for three seconds. The Network light of the camera begins to twinkle at high frequency. (every 0.4 seconds)
- (2) Press and hold the WPS button for three seconds on your wireless router **within 60 seconds**. Then the camera will automatically create a secure wireless connection to your router in about 60 seconds.
- (3) The IP Camera Tool will search the camera's LAN IP. Make sure the PC and the camera share the same subnet.

NOTE :

The security mode of router cannot be WEP, or else the WPS settings may be failed.

4.4.3 PPPoE

Some models support PPPoE.

If you are using a PPPoE connection, enable it and enter the User Name and Password for your PPPoE

account.

Use PPPoE

PPPoE account	<input type="text" value="sz1025441266512"/> The maximum length of the user name is 20, support numbers, letters and symbols @ . \$ * - _
PPPoE password	<input type="password" value="●●●●●●●●"/> The maximum password length is 12, does not support the character & =

Note: Once you save your settings, the camera will restart.

NOTE:

Some models does not have this function.

4.4.4 DDNS

FOSCAM camera has embedded a unique DDNS domain name when producing, and you can directly use the domain name, you can also use the third party domain name.

FOSCAM domain name

Here take **test09.myfoscam.org** for example. Go to option of DDNS on the **Settings->Network** panel, you can see the domain name.

Enable DDNS

Manufacturer's DDNS

Manufacturer's DDNS	<input type="text" value="test09.myfoscam.org"/>	<input type="button" value="Restore DDNS to factory"/>
---------------------	--	--

Third Party DDNS

DDNS Server	<input type="text" value="None"/>
Domain	<input type="text"/>

Now you can use **http:// Domain name + HTTP Port** to access the camera via internet.

Take hostname **test09.myfoscam.org** and HTTP Port no. 800 for example, the accessing link of the camera via internet would be **http:// test09.myfoscam.org:800**

Restore DDNS to factory: If you have configured Third Party DDNS successfully, but you want to use Manufacturer's DDNS again , here click this button and start Manufacturer's DDNS Service.

User can also use third part DDNS, such as www.no-ip.com ,www.3322.com

4.4.5 UPnP

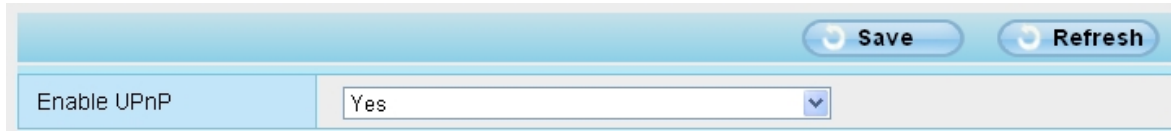

Save Refresh

Enable UPnP Yes

The default UPnP status is closed. You can enable UPnP, then the camera’s software will be configured for port forwarding. Back to the “**Device Status**” panel, you can see the UPnP status:



Device Status	
Alarm Status	Disabled
Recording Status	Not Recording
SD Card Status	No SD card
SD Card Free Space	0KB
SD Card Total Space	0KB
NTP Status	Success
DDNS Status	Success http://fast09.myfoscam.org:800
UPnP Status	Success
WIFI Status	Not connected
IR LED Status	Off

The camera’s software will be configured for port forwarding. There may be issues with your routers security settings, and sometimes may error. We recommend you configure port forwarding manually on your router.

4.4.6 Port

This camera supports HTTP Port. HTTP Port is used to access the camera remotely. If you want to access the camera and view the video, the HTTP Port must both be configured correctly.

HTTP port: By default, the HTTP is set to 88. Also, they can be assigned with another port number between 1 and 65535. But make sure they can not be conflict with other existing ports like 25, 21.

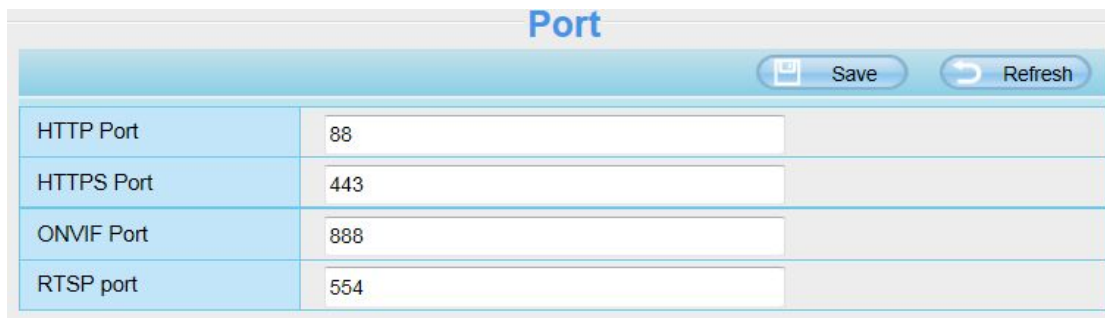

Port	
HTTP Port	88
HTTPS Port	443
ONVIF Port	888
RTSP port	554

Another way to change the HTTP port NO.

Step 1: Open the IP Camera Tool, select the camera you would like to change the port of, right click on the IP address, and click on "Network Configuration", this brings up the network configuration box as flowing figures.

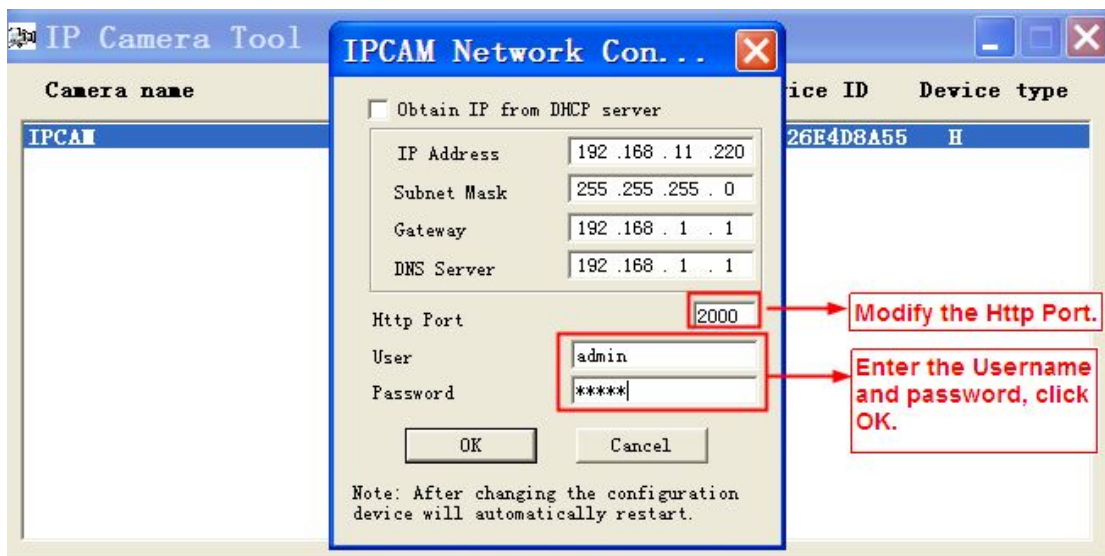
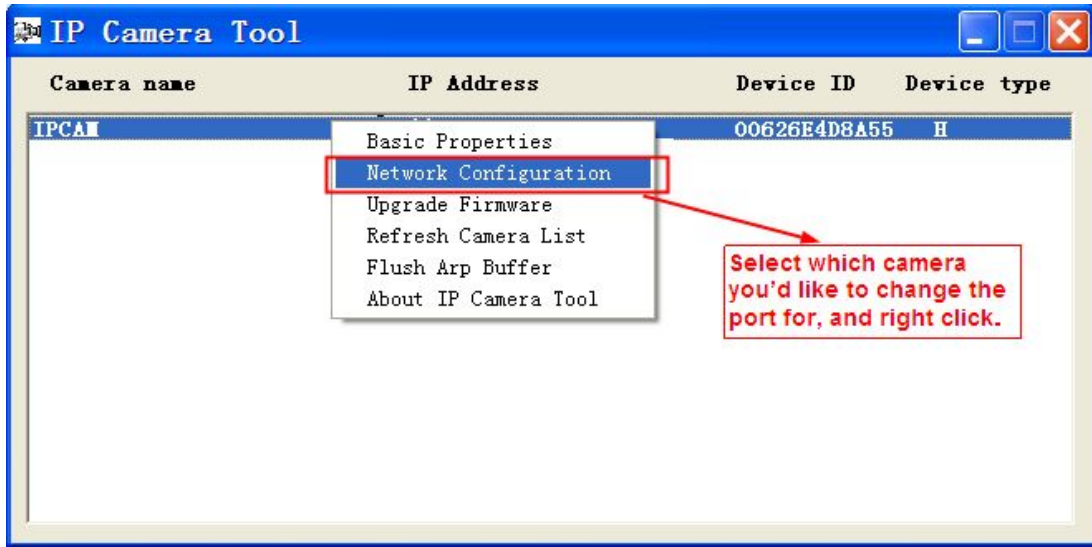

Step 2: Enter the username and password of the Administrator (default username is admin with a blank password), and click "OK" to apply changes.

Step 3: Wait around 10 seconds, you'll see that the camera's LAN IP address has changed. In our example it was changed to 2000, so we see http://192.168.8.102:2000 in IP Camera Tool. Also, the LAN IP address is now fixed at a static IP address of http://192.168.8.102:2000. This IP address will not change even if the camera is powered off and back on, the camera will remain on this LAN IP address. This is very important that a static LAN IP address is set, or you may have problems later with remote access and seeing the camera remotely if the camera loses power and reconnects on a different LAN IP address. Make sure you set a static LAN IP address!

Camera name	IP Address	Device ID	Device type
IPCAM	Http://192.168.11.220:88	00626E4D8A55	H

If the camera cannot be accessed, please make sure the port forwarding is succeed.

ONVIF port: By default, the ONVIF port is set to 888. Also, they can be assigned with another port number between 1 and 65535(except 0 and 65534). But make sure they can not be conflict with other existing ports.

HTTPS port: The default port is 443. You can use the url to access the camera: **https:// IP + HTTPS port.**

RTSP port: The default port is 443. Only some IP Cameras have RTSP port.

4.4.7 Mail Settings

If you want the camera to send emails when motion has been detected, here Mail will need to be configured.

1---- SMTP Server/ Port /Transport Layer Security Enter SMTP server for sender. **SMTP** port is usually set as 25. Some SMTP servers have their own port, such as 587 or 465, and Transport Layer

Security usually is None. If you use Gmail, Transport Layer Security must be set to TLS or STARTTLS and SMTP Port must be set to 465 or 25 or 587, which port you choose should be decided by which Transport Layer Security you select.

2---- **SMTP Username/ password** ID account and password of the sender email address

3---- **Sender E-mail** Mailbox for sender must support SMTP

4---- **Receiver** Mailbox for receiver need not support SMTP,you can set 4 receivers

5---- **Save** Click Save to take effect

6---- **Test** Click Test to see if Mail has been successfully configured.

Click **Test** to see if Mail has been successfully configured.

The screenshot shows a web-based configuration form for email settings. At the top right, there are 'Save' and 'Refresh' buttons. The form is titled 'Enable' with a checked checkbox. The fields are as follows:

- SMTP Server:** smtp.gmail.com. Below the input field, it says 'SMTP server address supports English, numbers and @ _ . -'.
- SMTP Port:** 25.
- Transport Layer Security:** STARTTLS (selected in a dropdown). Below the dropdown, it says 'G-Mail only supports TLS at Port 465 and STARTTLS at Port 587 or 25. Hotmail only supports STARTTLS at Port 587 or 25.'
- Need Authentication:** Yes (selected in a dropdown).
- SMTP Username:** test123@gmai.com. Below the input field, it says 'The maximum length of the user name is 63, support numbers, letters and symbols @ _ . \$ * -'.
- SMTP Password:** [Redacted with dots]. Below the input field, it says 'The maximum password length is 32, does not support the character & ='.
- Sender E-mail:** test123@gmai.com. To the right of the input field is a 'Test' button. Below the input field, there is a red-bordered box containing the text 'Success' and 'Test result.'.
- First Receiver:** test@163.com. Below the input field, it says 'The maximum length of the receiver is 63, support numbers, letters and symbols @ _ . \$ * -'.
- Second Receiver:** tset@hotmail.com.
- Third Receiver:** [Empty input field].
- Fourth Receiver:** [Empty input field].

If the test success, you can see the Success behind the Test, at the same time the receivers will receive a test mail.

If the test fails with one of the following errors after clicking **Test**, verify that the information you entered is correct and again select Test .

- 1) Cannot connect to the server
- 2) Network Error. Please try later
- 3) Server Error
- 4) Incorrect user or password
- 5) The sender is denied by the server. Maybe the server need to authenticate the user, please check it

and try again

- 6) The receiver is denied by the server. Maybe because of the anti-spam privacy of the server
- 7) The message is denied by the server. Maybe because of the anti-spam privacy of the server
- 8) The server does not support the authentication mode used by the device

4.4.8 FTP Settings

If you want to upload record files and images to your FTP server, you can set **FTP Settings**.

The screenshot shows the 'FTP Settings' configuration window. At the top right, there are 'Save' and 'Refresh' buttons. The settings are as follows:

FTP Server	ftp://192.168.8.150 Example:ftp://192.168.1.103/dir The maximum length of the address is 127, does not support the character & =
Port	21
FTP Mode	PORT
Username	yaocuixiang The maximum length of the user name is 63, support numbers, letters and symbols _ @\$ * - , . # !
Password	●●●●●●●● The maximum password length is 63, does not support the character & =
<input type="button" value="Test"/>	Success

Figure a

The screenshot shows the 'FTP Settings' configuration window for an internet-accessible server. At the top right, there are 'Save' and 'Refresh' buttons. The settings are as follows:

FTP server	ftp://ftp.mgenseal.com example:ftp://192.168.1.103
Port	21
FTP Mode	PORT
User name	deotestge
Password	●●●●●●●●
<input type="button" value="Test"/>	Success

Figure b

FTP server: If your FTP server is located on the LAN, you can set as Figure a.

If you have an FTP server which you can access on the internet, you can set as Figure b.

Port: Default is port 21. If changed, external FTP client program must change the server connection port accordingly.

FTP Mode: Here supports two modes: PORT and PASV.

Username/password: The FTP account and password.

Click **Save** to take effect.

Click **Test** to see if FTP has been successfully configured.

4.4.9 P2P

Access the IP Camera by Smart Phone (Android or iOS operating system)

First of all, you must open the P2P function of the IP Camera at “**Settings --> Network --> P2P.**”

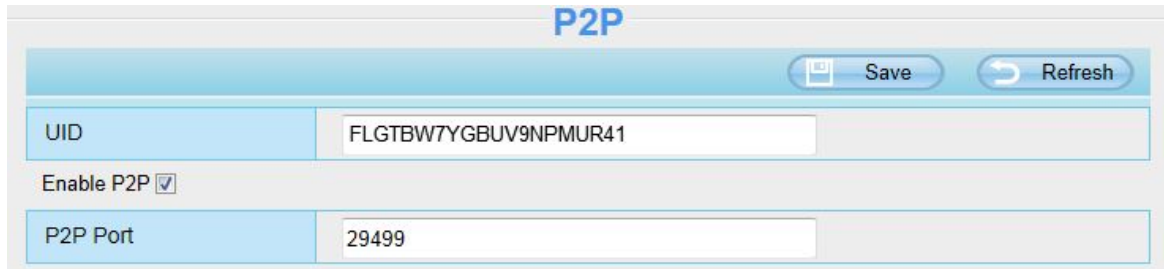

P2P	
	<input type="button" value="Save"/> <input type="button" value="Refresh"/>
UID	FLGTBW7YGBUV9NPMUR41
Enable P2P	<input checked="" type="checkbox"/>
P2P Port	29499

Foscam App named **Foscam** on App Store and Google Play for iOS and Android devices

NOTE:

If the QR code scanning is not successful, please input the UID on the bottom of the camera manually.

4.5 Video

This section allows you to configure Video stream settings, On screen display and Snapshot settings.

4.5.1 Video Settings

There are two ways to set the stream video settings. They are main stream video settings and sub stream video settings.

Video Settings

Main stream video settings

Enhanced Night Vision Definition

Stream Type	HD Mode
Resolution	720P
Bit Rate	2M
Frame Rate	30
Key Frame Interval	30
Variable bitrate	Yes

Sub stream video settings

Stream Type	HD Mode
Resolution	720P
Bit Rate	512K
Frame Rate	10
Key Frame Interval	30

Stream type: There are four types to identify different streams you have set.

Resolution: The camera supports multiple types. The higher the resolution is the clearer video will become. But the code flux will become larger too, and it will take up more bandwidth. (The maximum frame rate for each model is different.)

Bit Rate: Generally speaking, the larger the bit rate is, the clearer video will become. But the bit rate configuration should combine well with the network bandwidth. When the bandwidth is very narrow, and bit rate is large, that will lead to video can not play well.

Frame rate:Note that a larger frame size takes up more bandwidth. You should lower frame rate when the bandwidth is limited. Normally, when the frame rate above 15, you can achieve fluently video.The maximum frame rate for each model is different.

Key Frame Interval: The time between last key frame and next key frame. The shorter the duration, the more likely you will get a better video quality, but at the cost of higher network bandwidth consumption.

Variable Bitrate: The two options are Yes and NO. Select Yes the bit rate is variable, and the highest value isn't higher than Bit Rate Value (2Mbps). Select NO and the bit rate is constant with Bit Rate Value (2Mbps).

4.5.2 On Screen Display

This page is used to add timestamp and device name on the video.

OSD

Display Timestamp	Yes
Display Camera Name	Yes

Display Time stamp

There are two options: Yes or NO. Select Yes and you can see the system date on the video.

Display Camera Name

There are two options: Yes or NO. Select Yes and you can see the device name on the video.

4.5.3 Privacy Zone

Some models do not support this Function.

This page is used to set some mask as privacy zone on the video.

Allow Privacy Zone	Yes
<input type="button" value="Set Privacy Zone"/>	

Allow On Screen Display Mask

There are two options: Yes or NO. Select yes and draw a mask area on the video, the mask area will be black on the video.



Click **OK** button and return to the OSD page, click Save to take effect.
 Back to the surveillance window, you can see the mask area as the following picture:

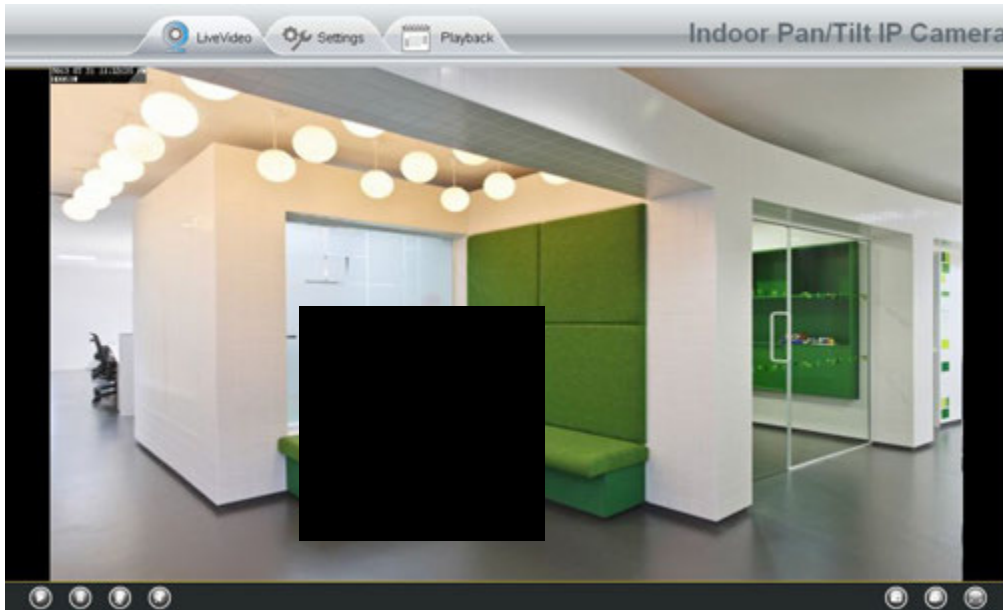

NOTE:
 Some models does not have this function.

4.5.4 Snapshot Settings

On this page you can set the snapshot pictures' image quality and the storage path.

Snapshot Settings

Manual snap Quality	Medium
Pictures Save To	None

Enable timing to capture:

Capture interval	2	(1-65535s)
------------------	---	------------

All	00	01	02	03	04	05	06	07	08	09	10	11	12	13	14	15	16	17	18	19	20	21	22	23
MON																								
TUE																								
WED																								
THU																								
FRI																								
SAT																								
SUN																								

Manual snap Quality: Low, Middle and High. The higher the quality, the picture will be clearer.
Pictures Save To: FTP or SD card. If you have done FTP and Alarm settings, when alarming, the camera will snap pictures to the FTP or SD card automatically.

Enable timing to capture

To enable capture interval, follow the steps below:

1 Select **Enable Motion detection**

2 Capture interval:The interval time between two captures.

3 Select the capture time

- Capture anytime

Click the black button up the MON, you will see all time range turn red. When something moving in the detection area at anytime, the camera will capture.

- Specify an capture schedule

Click the week day words, the corresponding column will be selected. For example, click TUE, the all column of TUE turns to red, that means during Tuesday whole day, the camera will capture.

- Press the left mouse and drag it on the time boxes, you can select the serial area,

4 Click Save button to take effect.

4.5.5 IR LED Schedule

On this page you can set the schedule time for switching IR LED lights. When parameter Mode is set to the **Schedule** on the **Live Video** window, at these schedule time, the IR LED lights will be turned off.

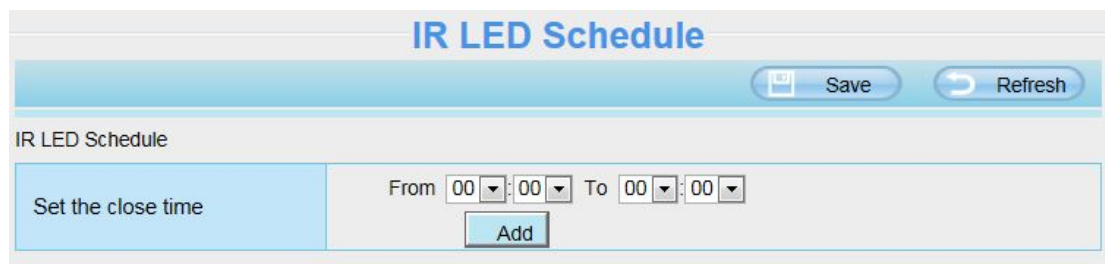

The screenshot shows a web interface titled "IR LED Schedule". At the top right, there are "Save" and "Refresh" buttons. Below the title, the text "IR LED Schedule" is displayed. A light blue box contains the text "Set the close time". To the right of this box, there are two time selection fields: "From" and "To", each with hour and minute dropdown menus. Below these fields is an "Add" button.

4.6 Alarm

4.6.1 Motion Detection

IP Camera supports **Motion Detection Alarm**, when the motion has been detected, the IP Camera will make a alarm.

Motion Detection

7 Save Refresh

Enable <input checked="" type="checkbox"/>	1
Sensitivity	2 Medium
Triggered Interval	3 10s
Action	<input type="checkbox"/> Camera Sound <input type="checkbox"/> PC Sound
	<input checked="" type="checkbox"/> Send E-mail
	<input type="checkbox"/> Take Snapshot Time Interval 4 2s
	Please set the capture storage location in advance.
	<input type="checkbox"/> Recording Please set the video storage location in advance.
<input type="checkbox"/> IO Output Clear IO Alarm Output	
5 Set Detection Area	
6 Schedule	

All	00	01	02	03	04	05	06	07	08	09	10	11	12	13	14	15	16	17	18	19	20	21	22	23
MON																								
TUE																								
WED																								
THU																								
FRI																								
SAT																								
SUN																								

Step 1: Enable Motion detection

Step 2: Sensitivity---- It supports five modes: Lowest, Lower, Low, Medium and High. The higher the sensitivity, the camera will be more easily alarmed. Select one motion sensitivity.

Step 3: Trigger interval--- The interval time between two motion detection.

Step 4: There are some alarm indicators:

A Camera Sound and PC Sound

If the camera has connected with a speaker or other audio output device, if you select Camera Sound or PC Sound, when the motion has been detected, the people around the camera will hear beep alarm sound.

B Send E-mail

If you want to receive alarm emails when motion is detected, you must select Send E-mail and set Mail Settings first.

C Take Snapshot

If you select this checkbox, when the motion has been detected, the camera will snap the live view window as a still picture and load it to the FTP. Make sure you have set FTP and set FTP as the storage path in Video->Snapshot settings panel.

Capture interval: The interval time between two pictures.

D Recording

If you select this checkbox, when the motion has been detected, the camera will record automatically and store the record files to the SD Card. Make sure the camera has inserted SD card and you have set the SD card as the Alarm record files storage path, please go to **Record—> Storage location** page to verify this settings.

The default alarm record time is 30s and pre-alarm record time is 5s, please go to **Record—> Alarm Record** page and change the alarm time settings.

E IO Output(Only 9815P)

If IO alarm is triggered and IO alarm output device will always alarm (sound alarm is issued a warning sound, alarm lights in flash etc.). Click "Clear IO alarm output" , the alarm output device will stop alarming. If IO alarm is triggered again after alarm interval, IO alarm output device will be restart.

Step 5: Set detect area

Click set detect area and it pop up a window, then you can draw the detection area. Click **Back** button after settings. When something moving in the detection area, the camera will alarm.

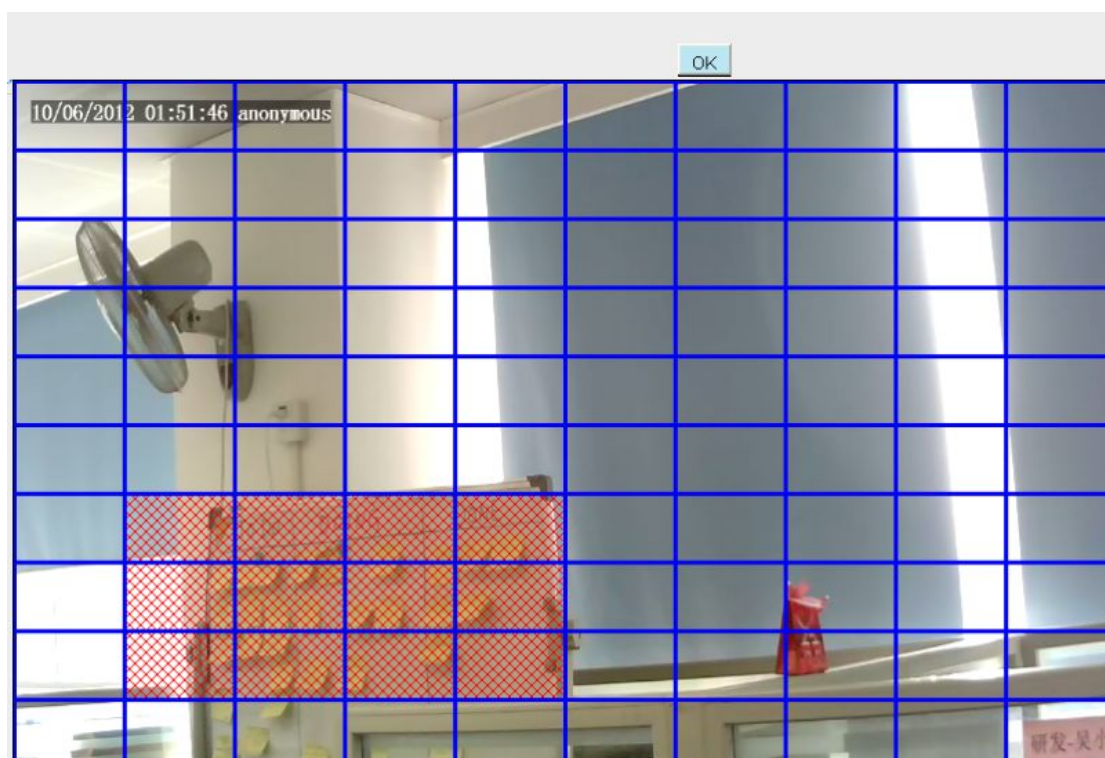

Step 06: Alarm Schedule

① Alarm anytime when motion is detected

Click the black button up the MON, you will see all time range turn red. When something moving in the detection area at anytime, the camera will alarm.

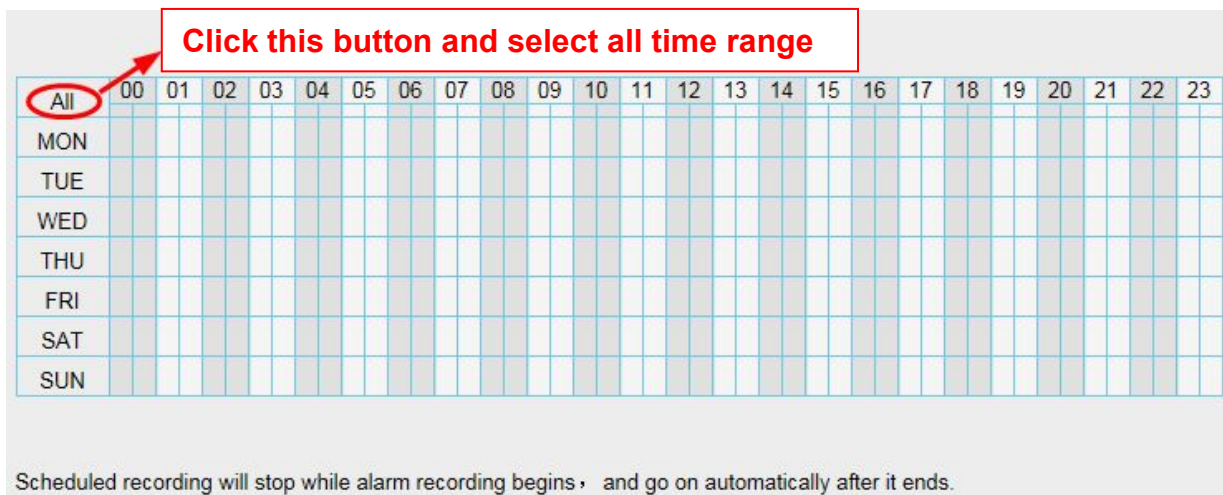

② Specify an alarm schedule

Click the week day words, the corresponding column will be selected. For example, click TUE, the all column of TUE turns to red, that means during Tuesday whole day, when something moving in the detection area, the camera will alarm.

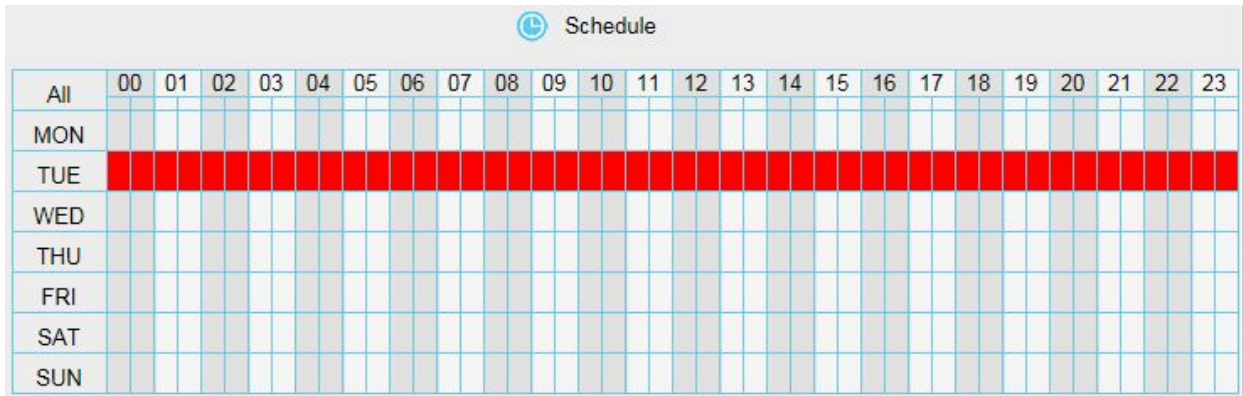

③ Press the left mouse and drag it on the time boxes, you can select the serial area.

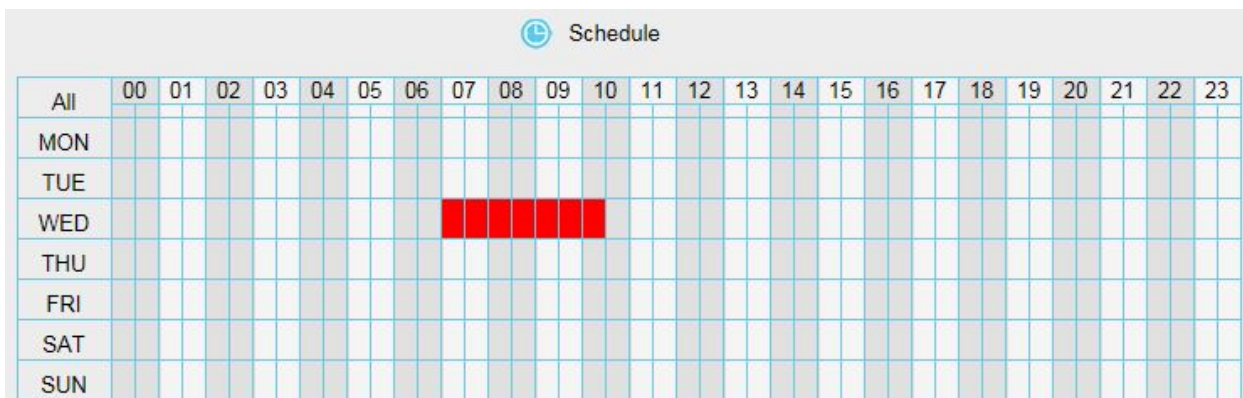

Step 07: Click Save button to take effect.

When the motion has been detected during the detection time in the detection area, the camera will alarm and adopt the corresponding alarm indicators.

NOTE: You must set the detection area and detection schedule, or else there is no alarm anywhere and anytime.

4.6.2 Sound alarm

Some models support Sound alarm.

When the ambient sound over a certain decibel ,the sound alarm will be triggered.

Sound alarm

Enable

Sensitivity	High	
Triggered Interval	5s	
Action	Camera Sound <input type="checkbox"/> PC Sound <input type="checkbox"/>	
	Send E-mail <input type="checkbox"/>	
	Take Snapshot <input type="checkbox"/> Time Interval 2s	
	Please set the capture storage location in advance.(Video -> Snapshot Settings)	
	Recording <input type="checkbox"/>	
Please set the video storage location in advance.(Record -> Storage Location)		

All	00	01	02	03	04	05	06	07	08	09	10	11	12	13	14	15	16	17	18	19	20	21	22	23
MON																								
TUE																								
WED																								

If the Sensitivity is set to “High”, the camera will detect the sound whose more than 55db.
If the Sensitivity is set to “Medium”, the camera will detect the sound whose more than 65db.
If the Sensitivity is set to “Low”, the camera will detect the sound whose more than 75db.
If the Sensitivity is set to “Lower”, the camera will detect the sound whose more than 85db.
If the Sensitivity is set to “Lowest”, the camera will detect the sound whose more than 95db.

4.6.3 IO Alarm(Only 9815P)

This IP camera provides a I/O alarm terminal block which is used to connect to external input / output device.

The alarm device(door sensor, infrared sensor, smoke detectors, etc) send input command to the network camera, then the network camera send output command to the alarm output device(local audible alarm, lights alarm,etc.).

IO

Enable

Trigger level	Low
Triggered Interval	10s
Action	<input type="checkbox"/> Camera Sound <input type="checkbox"/> PC Sound
	<input checked="" type="checkbox"/> Send E-mail
	<input type="checkbox"/> Take Snapshot Time Interval <input type="text" value="2s"/>
	Please set the capture storage location in advance.
	<input type="checkbox"/> Recording Please set the video storage location in advance.
<input type="checkbox"/> IO Output <input type="button" value="Clear IO Alarm Output"/>	

All	00	01	02	03	04	05	06	07	08	09	10	11	12	13	14	15	16	17	18	19	20	21	22	23
MON																								
TUE																								
WED																								
THU																								
FRI																								
SAT																								
SUN																								

Figure c

There is an IO alarm input/output lines in the FOSCAM camera rear, as shown in Figure c. Enable IO alarm need this cable to connect to the alarm device (door sensor, infrared sensor, smoke detector, etc.).

I/O Alarm has four ports:

- Port 1 and port 2 indicate IO alarm output
- Port 3 and port 4 indicate IO alarm input



Setting IO alarm

On the IO page, Enable the I/O alarm, select the “**Send E-mail**”and “**Snapshot**” before you have configured the mail and FTP.

If an IO alarm is triggered and IO alarm output device will always alarm (sound alarm is issued a warning

sound, alarm lights in flash etc.). Click "Clear IO alarm output" , the alarm output device will stop alarming. If IO alarm is triggered again after alarm interval, IO alarm output device will be restart.

4.7 Record

This section will allow you to change the record files storage path and the record time.

4.7.1 Storage Location

On this page you can change the alarm and manually recording storage path.

Storage Location

Recording Location	None	
Local Recording Location	c:\IPCamRecord	<input type="button" value="Browse"/> <input type="button" value="Enter the local folder"/>

Recording Location is used for alarm recordings and schedule recordings.

The local recording must be stored in local storage. The default Windows storage location is "c:\IPCamRecord". The default Mac OS storage location is "/IPCamRecord". If you modify the path on other cameras, this default storage location will be modified accordingly.

Alarm Recording Location : SD card, FTP.

Check "SD card" : The video will be saved in SD card. **Make sure the camera has been inserted the SD card.** On this page, you can see the available space of the SD card.

Check "FTP" : The video will be saved in FTP. Please refer to "FTP settings."

Local Recording Location: For Windows OS, the manual recording path is C:/ IPCamRecord, you can change another one. For MAC OS, the manual recording path is: / IPCamRecord.

Enter the local folder :Click here,you can enter the local folder.

4.7.2 Alarm Recording

Alarm Recording

Enable Pre-Record

Pre-recorded Time	2s
Alarm Recording Time	30s

4.7.3 Local Alarm Recording

This page you can enable the local alarm record and Local Alarm record time.

Local Alarm Recording

Enable Local Alarm Recording

Local Alarm Recording Time:

4.7.4 Schedule Recording

When the video is selected as FTP, the device supports scheduled recording.

Storage Location

Recording Location:

Local Recording Location:

Scheduled Recording To FTP

Enable Scheduled Recording

Stream:

Edit Scheduled Recording

	00	01	02	03	04	05	06	07	08	09	10	11	12	13	14	15	16	17	18	19	20	21	22	23
All																								
MON																								
TUE																								
WED																								
THU																								
FRI																								
SAT																								
SUN																								

When the video is selected as SD card, the device supports pumping frame recording.

When the parameter **Recording Location** is set **SD Card** on the **Storage Location** page, you can configure parameters as shown in follow figure.

Storage Location

Recording Location	<div style="border: 1px solid red; padding: 2px;">SD card</div> <div style="text-align: right; font-size: small;">372.2 MB / 7.4 GB</div>
Local Recording Location	<input type="text" value="c:\IPCamRecord"/> <input type="button" value="Browse"/>

Scheduled Recording To SD Card

Enable Scheduled Recording

Enable Long-time recording	No
Record frame	30
Record full strategy	Cover
Audio Record	No
Stream	Main stream

Edit Scheduled Recording

	00	01	02	03	04	05	06	07	08	09	10	11	12	13	14	15	16	17	18	19	20	21	22	23
All																								
MON																								
TUE																								
WED																								
THU																								
FRI																								

Record frame: There are six frame selections, such as 1/30, 4/30, 8/30, 15/30, 24/30, 30/30. Recommended default is 4/30. The greater the Frame rate is, the sharper picture quality is, and the greater of storage space is, the shorter the storage time is.

Record full strategy: When the SD card is full, you can choose to cover the previous recording, or stop recording.

Audio Record: You can choose "yes" or "no".

NOTES:

- Scheduled recording only supports video saved to the SD card or FTP server.
- The schedule recording will stop while alarm recording is beginning, and it will continue automatically after alarm recording end.
- You can refer to "alarm schedule." in "Alarm" about editing the time of recording Schedule.

4.7.5 SD Card Management

This camera supports SD Card and the max size of SD card must be under 32G.

When you plug in the SD card during the camera work process, please reboot the camera again, or else the SD Card may be cannot work well.

SD Card Management	
SD Card Status	No SD card
SD Card Free Space	0KB
SD Card Total Space	0KB

Note: SD card management is only effective when access the IPC in LAN

The default storage path of alarm record files is SD card, when the available size of SD card is less than 256M, the old record files will be deleted automatically.

4.8 PTZ

This page will allow you to change the pan/tilt speed and do cruise tracks settings.

4.8.1 Pan & Tilt Speed

There are five Pt speed types: very fast, fast, normal, slow and very slowly. Select the desired PTZ speed type and click save button.

There are three zoom speed types: fast, normal, slow.

NOTE: only FI9826P has zoom function.

Pan & Tilt Speed	
Pan & Tilt Speed	Normal
Zoom speed	Fast

4.8.2 Cruise Settings

This section explains how to add/ delete/ alter one cruise track.

Setting the Cruise Mode

There are two cruise mode: Cruise time and Cruise Loops.

Cruise time: Select **Cruise time** from **Cruise Mode** drop-down, then you can set the **Cruise time** of the camera.

Cruise Loops: Select **Cruise Loops** from **Cruise Mode** drop-down, you can set the **Cruise Loops** of the camera.

Click **Save** to take effect.

Cruise Mode	Cruise time
Cruise time	15 Minute
	Save

Cruise Mode	Cruise Loops
Cruise Loops	loops
	Save

Manage the Cruise Track

There are two default cruise tracks: Vertical and Horizontal.

Vertical: The camera will rotate from up to down

Horizontal: The camera will rotate from left to right.

Add: Add one cruise track, then click save button.

Delete: Select one cruise track and delete it.

Save: After you modify the **Dwell time**, you should click **Save** button to take effect.

Example

How to do add cruise tracks ?

Firstly, Click Add button and enter a descriptive name to identify the cruise track.

Secondly: On the lower left of the page, you can see all preset points you have added. Select one preset point and click Add button, you can see the preset point has been added to the cruise track on the cruise track page. You need to add two or more preset points to the cruise track.

The screenshot shows the 'Cruise Settings' interface. At the top, there is a 'Refresh' button. Below it, there are two dropdown menus: 'Cruise Mode' set to 'Cruise time' and 'Cruise time' set to '15 Minute'. A 'Save' button is located below these menus. The 'Cruise Tracks' section has a text input field containing 'test', with 'OK' and 'Cancel' buttons to its right. A note below the input field states: 'The maximum length of name is 20, supports English, numbers, letters and symbols _ -'. Below this, there are two panels. The left panel, titled 'Preset point', lists 'TopMost', 'BottomMost', 'LeftMost', and 'RightMost'. The 'LeftMost' item is highlighted in green. A red box with the text '1 Select one preset point.' points to this item. The right panel, titled 'Cruise track', shows a table with two columns: 'Preset point' and 'Dwell time'. The table contains two rows: 'BottomMost' with '1 Sec' and 'LeftMost' with '2 Sec'. The 'LeftMost' row is highlighted in green. A red box with the text '2 Click Add button.' points to the 'Add' button between the two panels. Another red box with the text 'Here you can see the preset point has been added to one track. And you can set the stay time.' points to the 'LeftMost' row in the table. A third red box with the text 'The new added track name.' points to the 'test' input field. A fourth red box with the text 'The maximum length of name is 20, supports English, numbers, letters and symbols _ -' points to the note below the input field.

Thirdly: Click **OK** button and the cruise track will take effect.

You can add other cruise track as the same method.

For example: I have added three preset points to the "track 1", that means : When I select the "track 1" on the surveillance window, the camera moves as the following track: upright then Right Most last down left.

You can add preset on the left of the surveillance window.

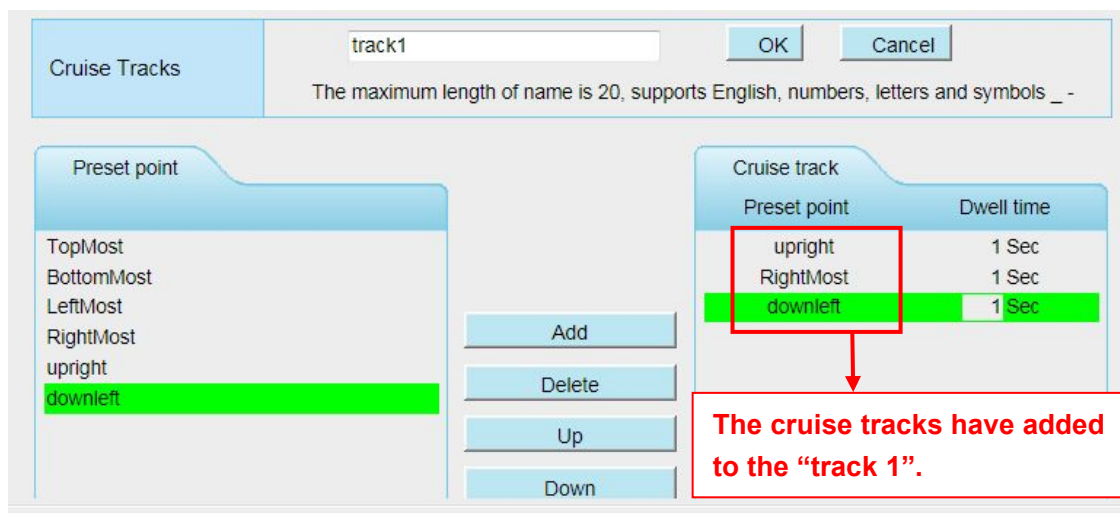

After add the cruise track, back to the surveillance window, click Cruise, her you can see all cruise tracks you have added.

After add the cruise track, back to the surveillance window, click Cruise, her you can see all cruise tracks you have added.

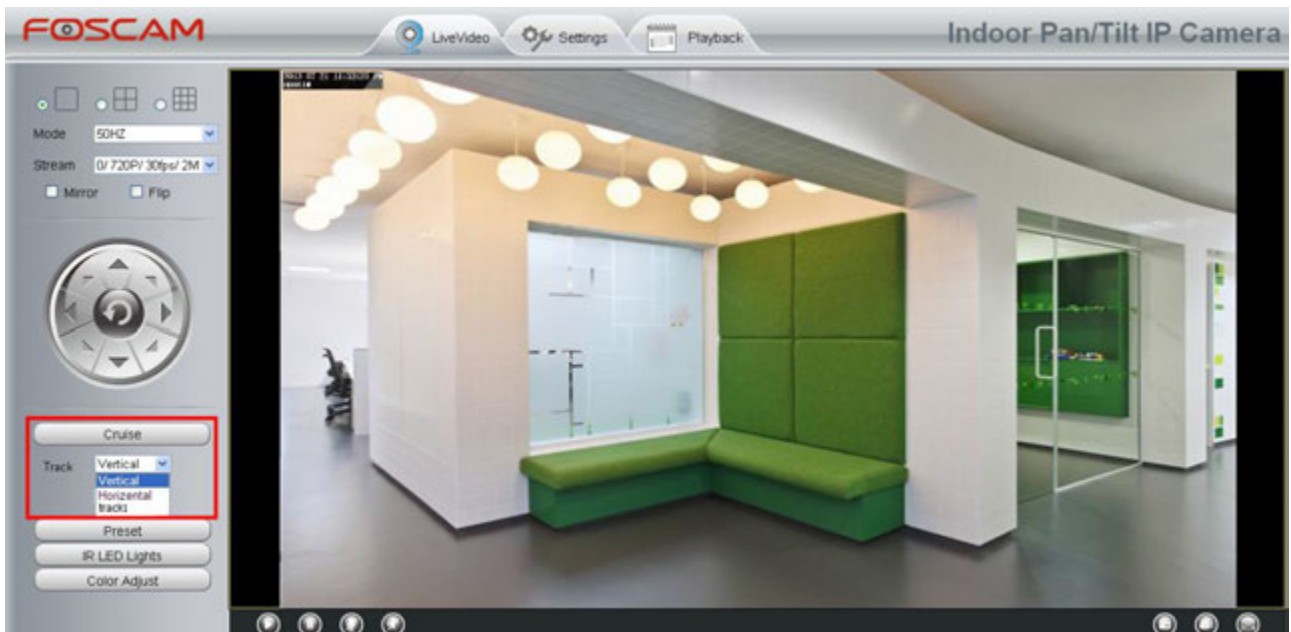

There are other buttons between the Preset points and Cruise track, you can use these buttons to adjust the order of preset points or add/delete one preset points in one cruise track.

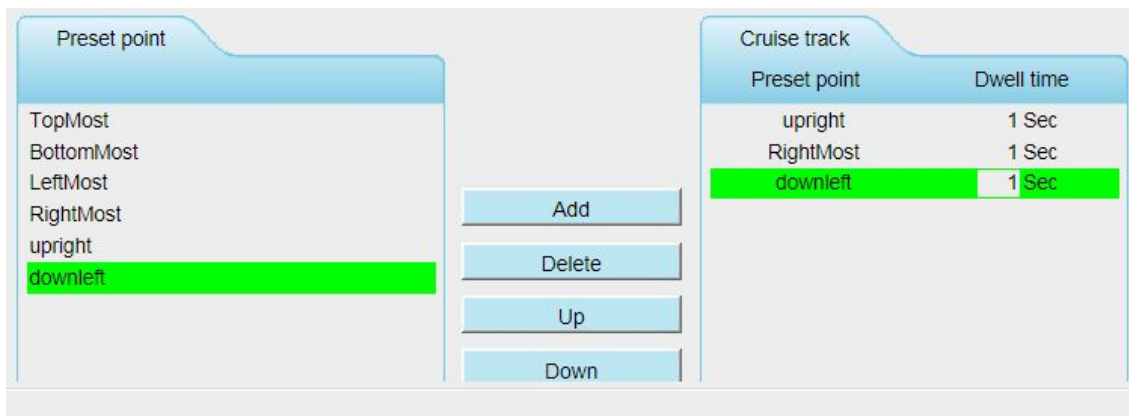

Add: Select one preset points and add it to the selected cruise track.

Delete: Select one preset points you have added to one cruise track, click delete.

Move up/ down: Select one cruise track, adjust the order of preset points in one cruise track.

Attention:

Considering the life time and thermal issue of the motor, it's not recommend to do long-time cruise.

4.8.3 Start-Up Options

Here section will allow you to set the stop position after the camera reboots.

It supports three modes: No self test, Goto home position and Goto preset point.

No self test: When rebooting, the camera will not pan / tilt.

Goto home position: When rebooting, the camera will pa Providing Central Management Software to manage or monitor multi-cameras n / tilt and stops at center.

Go to Preset point: Select one preset position and save it. When rebooting, the camera will pan/ tilt and

stops at the preset position you have set.

Start-Up Options

Save Refresh

Start-Up Option: Go To Home Position

Note: The cruise and preset function will be not available in case starts without self-test

4.9 Firewall

This section explains how to control the access permission by checking the client PC's IP addresses. It is composed of the following columns: **Block access from these IP addresses** and **Only allow access from these IP addresses**.

Save Refresh

Enable Firewall

IP Filtering: Block access from these IP addresses

IP Address #1	<input type="text"/>
IP Address #2	<input type="text"/>
IP Address #3	<input type="text"/>
IP Address #4	<input type="text"/>
IP Address #5	<input type="text"/>
IP Address #6	<input type="text"/>
IP Address #7	<input type="text"/>
IP Address #8	<input type="text"/>

Enable firewall, If you select Only allow access from these IP addresses and fill in 8 IP addresses at most, only those clients whose IP addresses listed in the **Only allow access from these IP addresses** can access the Network Camera. If you select **Block access from these IP addresses**, only those clients whose IP addresses are in the IP list cannot access the Network Camera.

Click **Save** to take effect.

4.10 System

In this panel, you can backup/restore your camera settings, upgrade the firmware to the latest version, restore the camera to default settings and reboot the device.

4.10.1 Back-up& Restore

Click **Backup** to save all the parameters you have set. These parameters will be stored in a bin file for future use.

Click Browse and select the parameters file you have stored, then click Submit to restore the restore the parameters.

Backup is used to save your current settings. It is recommended to backup your configuration before modifying or upgrading firmware.

Settings can be restored by uploading the backup file.

Path:

Note:

1. All current settings will be lost when importing a configuration file. If an incorrect file is loaded, the camera may stop working correctly.
2. Keep the power on during this process, or you may damage your camera. Your camera will reboot automatically once restoration is completed.

4.10.2 System Upgrade

Click “Download the latest firmware”, you will see the following screen. And click “save” to save the firmware on your computer locally.

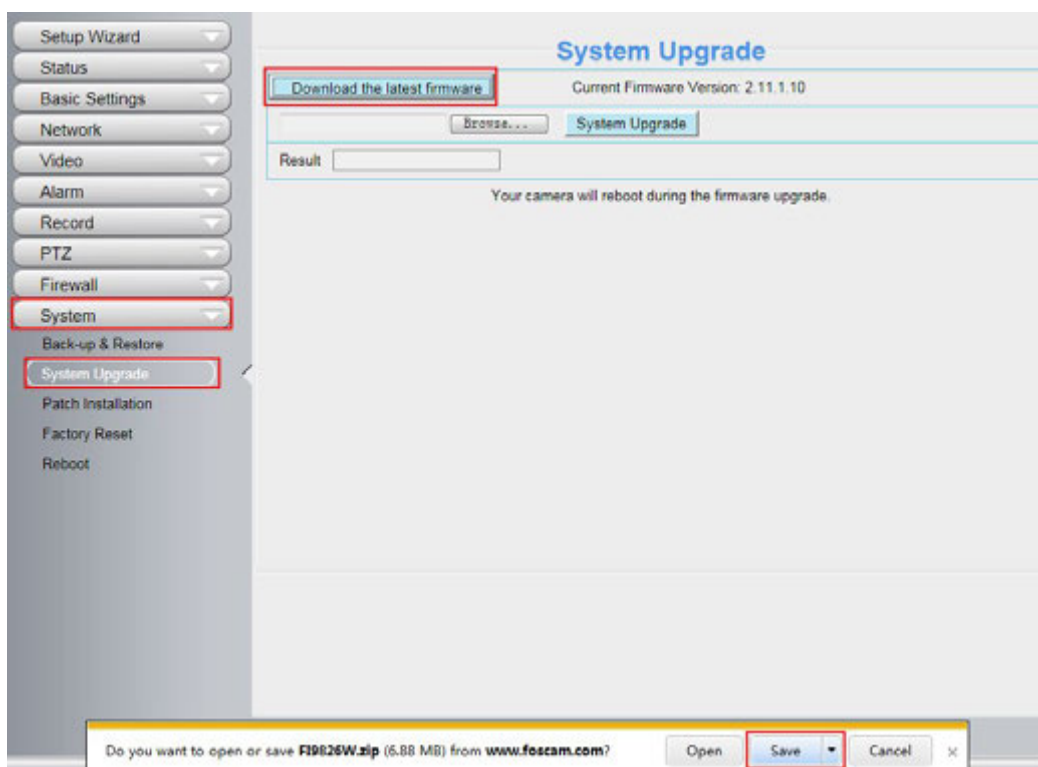

Your current firmware version will be displayed on your screen. You may go to the **Status** → **Device Information** page to check for the latest firmware versions available.

Click **Browse**, choose the correct bin file and then click **System upgrade**.

Don't shut down the power during upgrade. After upgrading, you can see the upgrade result.



Upgrade Firmware by IP Camera Tool



Double click the IP Camera Tool shot icon , select the Camera IP that you want to upgrade the firmware. Then select Upgrade Firmware and enter the username and password, choose the firmware file, and upgrade.

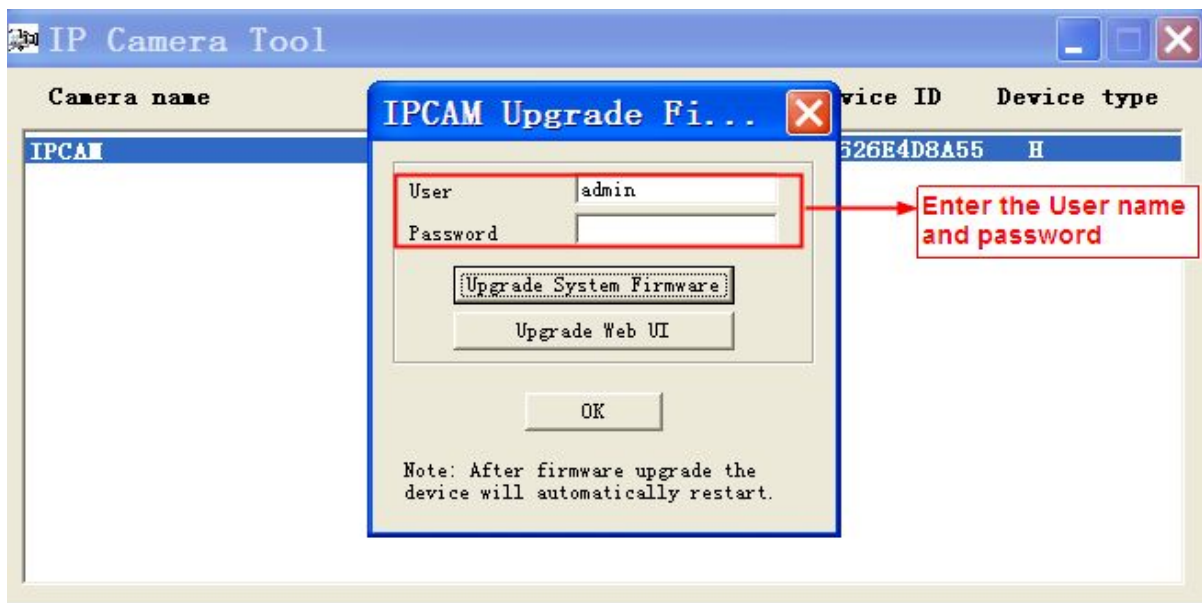
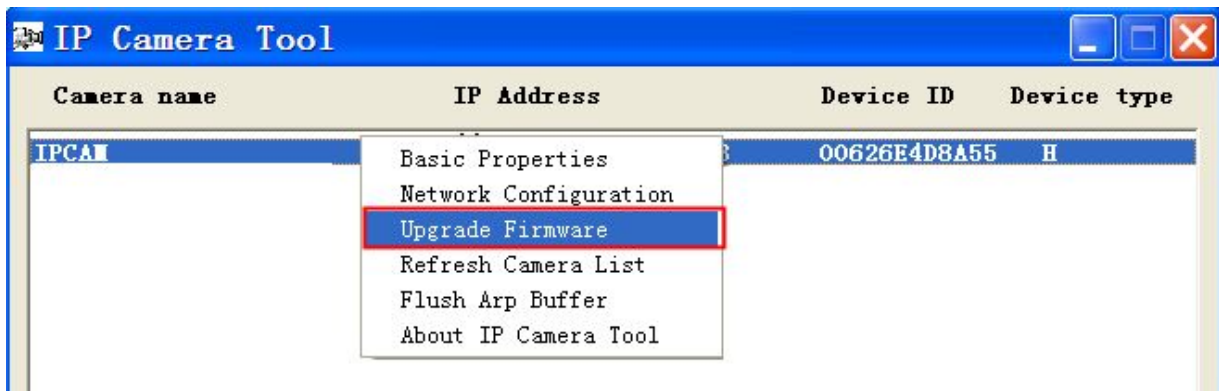

CAUTION: If your camera works well with the current firmware, we recommend not upgrading. Please don't upgrade the firmware unnecessarily. Your camera may be damaged if misconfigured during an upgrade.

NOTES:

- Please ensure you have download the correct firmware package for your camera before upgrading. Read the upgrade documentation (readme.txt file) in the upgrade package before you upgrade.
- Upon downloading the firmware check the sizes of the .bin files. They must match the size in the readme.txt file. If not, please download the firmware again until the sizes are the same. Your camera will not function correctly if a corrupt .bin file is used.
- Normally, only Device WEB UI need to be upgrade, please do not try to upgrade the Device System Firmware.
- Never shut down the power of the camera during upgrade until the IP camera restart and get connected.
- After upgrade successfully, please uninstall the old plugin and re-install it, then reset the camera to the default factory settings before using the camera.

4.10.3 Patch Installation

Click "Browse" to select the correct patch file, and then click "Install Patch" to install the patch. Do not turn off the power during it installing. After installing is complete, you will receive a system prompt.

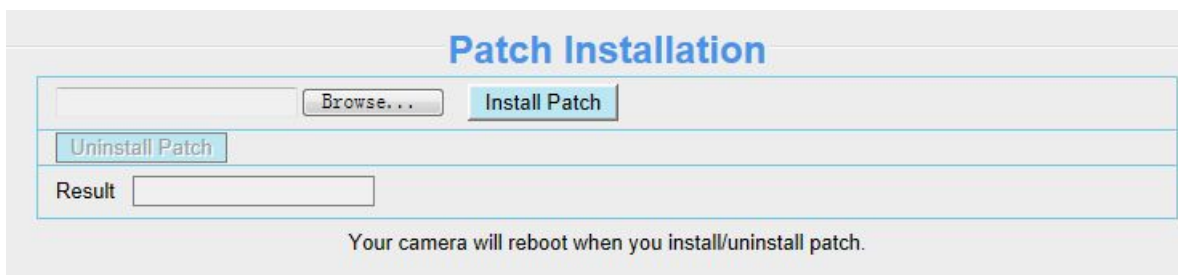

4.10.4 Factory Reset

Click All reset and all parameters will return to factory settings if selected. This is similar to press the Reset button on the bottom of the camera.



4.10.5 Reboot

Click Reboot System to reboot the camera. This is similar to unplugging the power to the camera.

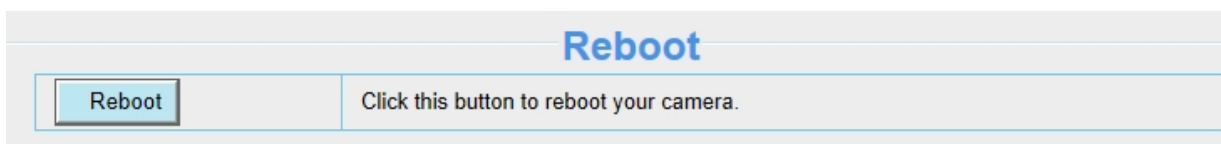

5 Playback

On this page you can view the record files stored in the SD card.

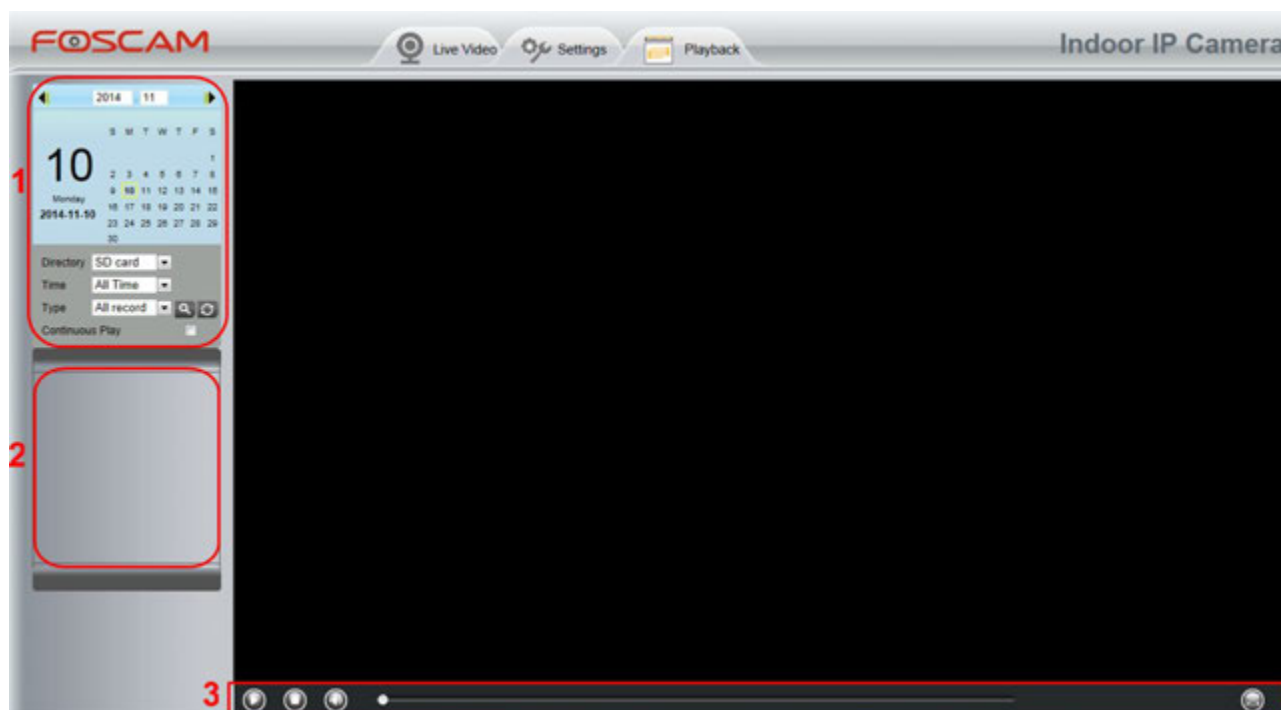

Section 1 Define the Record files time and Type

Directory : The storage path of record files

Time : Here supports three types: current day, current month and All records. Another way, select the time on the time&date manually.



Type : The type of records files, Here supports two types: Normal record, Alarm record and All records.

 : Click this button to search all record files satisfy the conditions you selected.

Continuous Play: Select the checkbox to play continuously all the record files.

Section 2 Search record files

On this panel you can see all record files satisfy the conditions you set.

Section 3 Play/Stop/Audio/Full screen buttons

Please select one record file before use these buttons.



Click this button to play the record files



Click this button to stop the record files



Open or stop audio



Click this button to make full screen, and double click left mouse to exit full screen.

6 Appendix

6.1 Frequently Asked Questions

6.1.1 Install the add-on of Firefox browser, Google Chrome and IE Chrome.

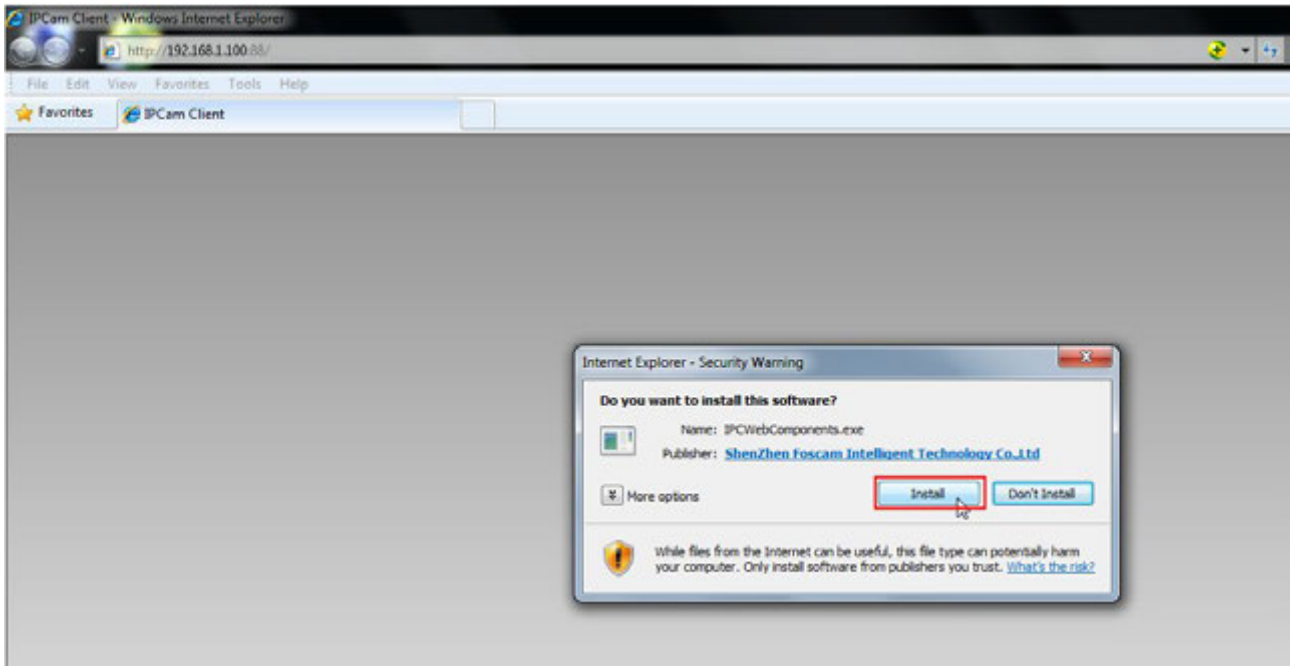

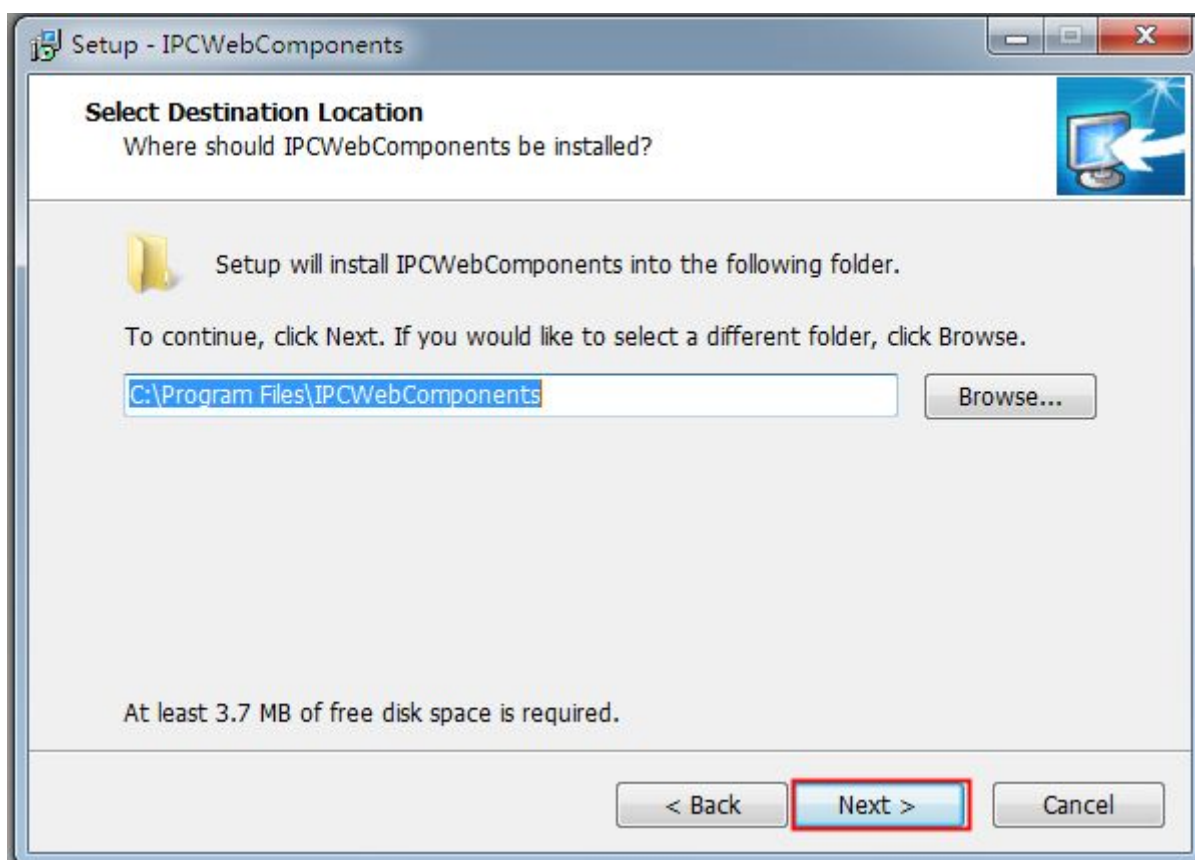
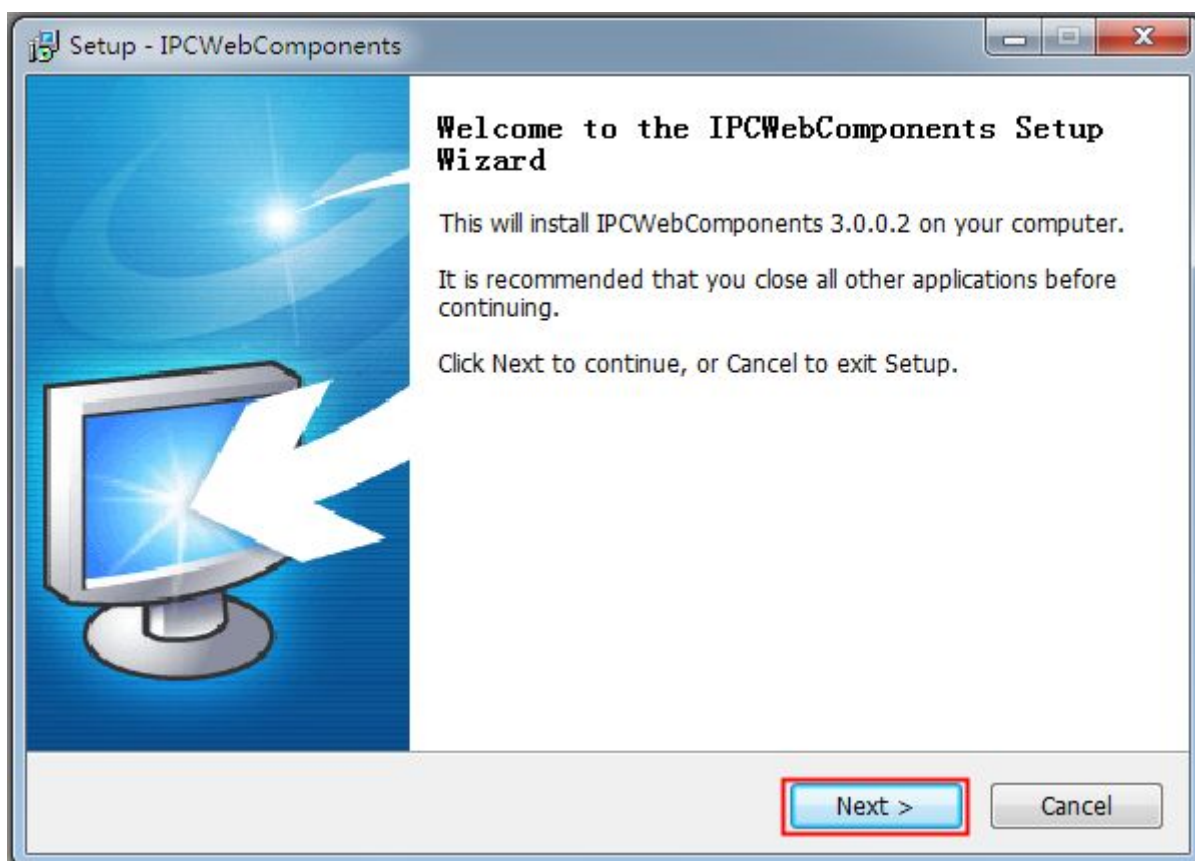

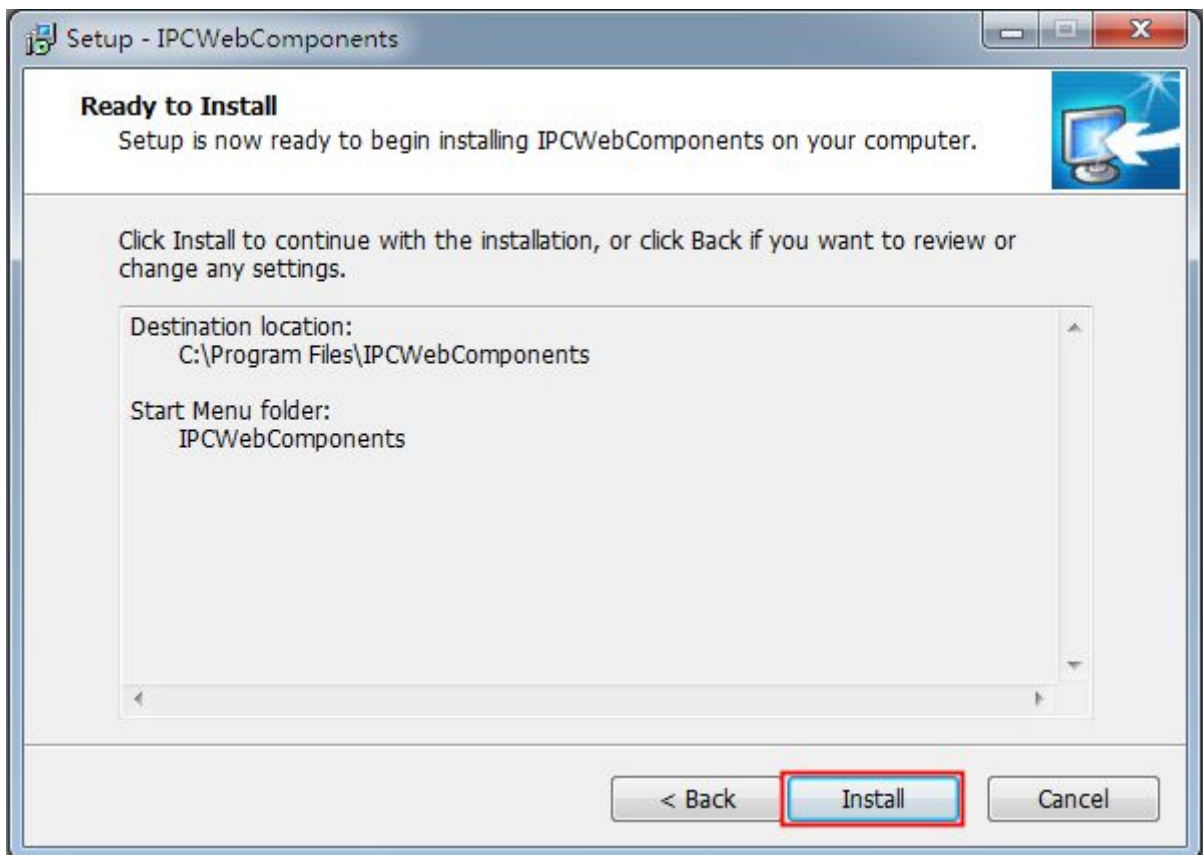
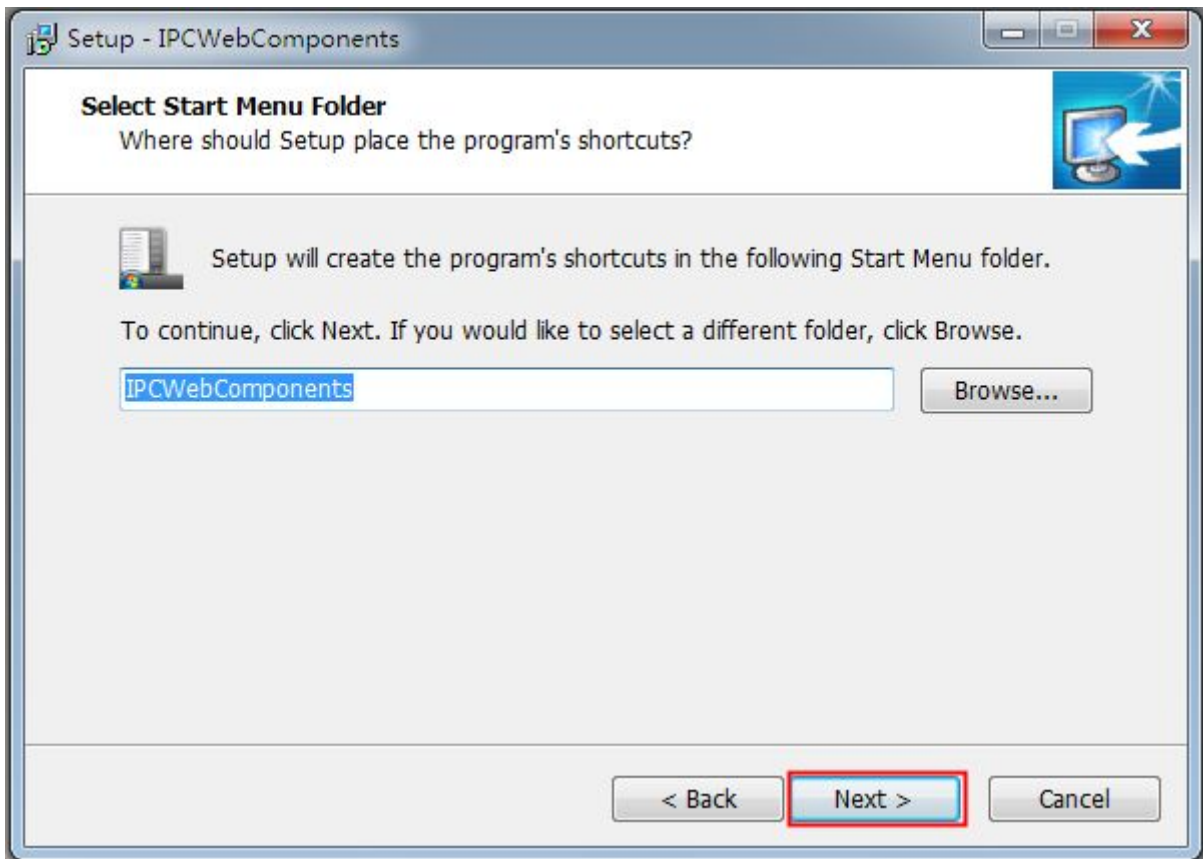

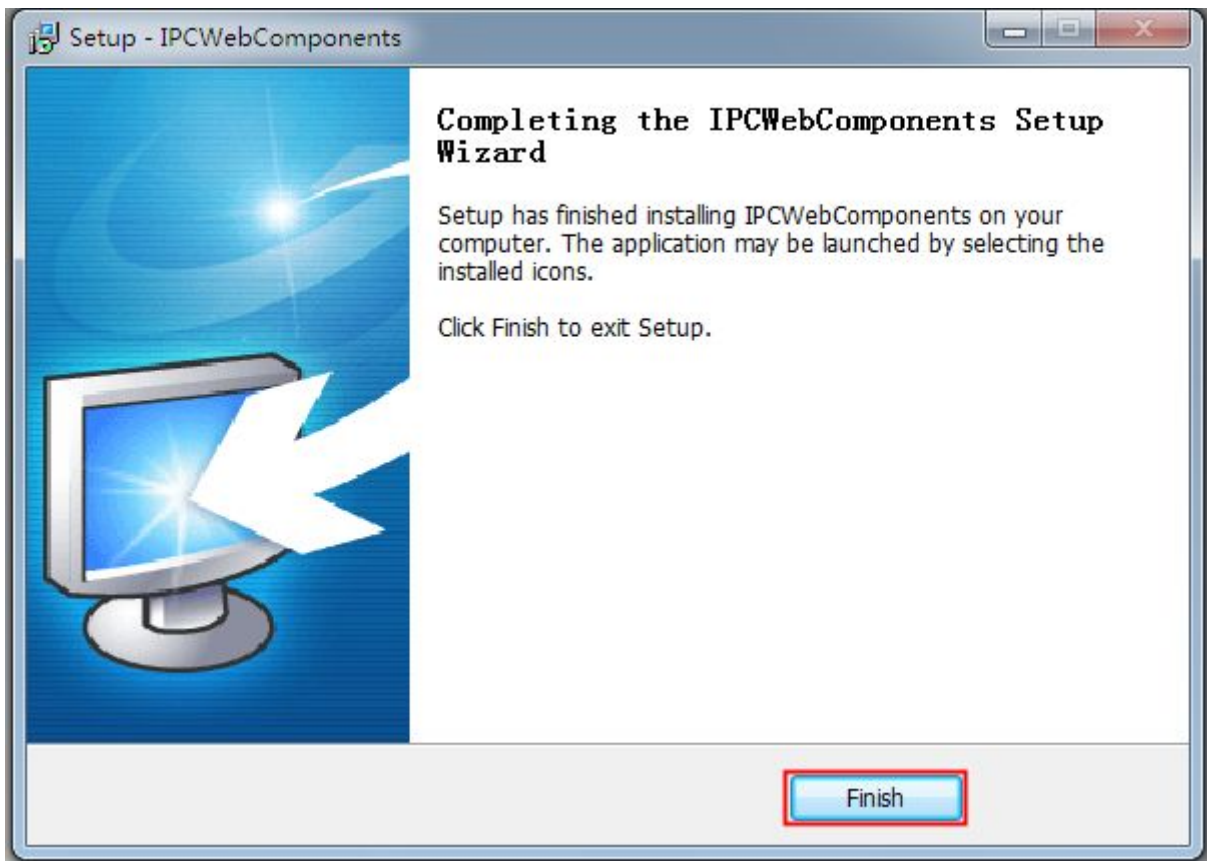

6.1.2 Uninstall the add-on of Firefox browser, Google Chrome and IE Chrome.

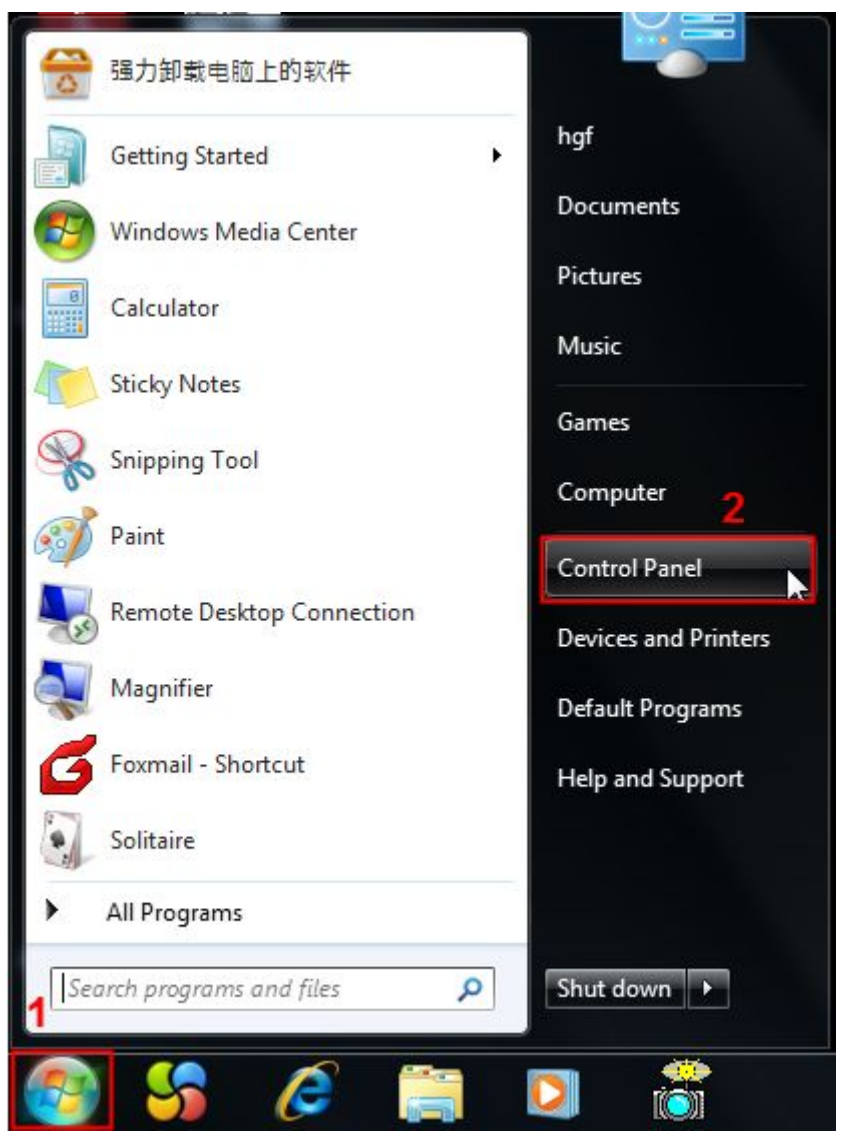

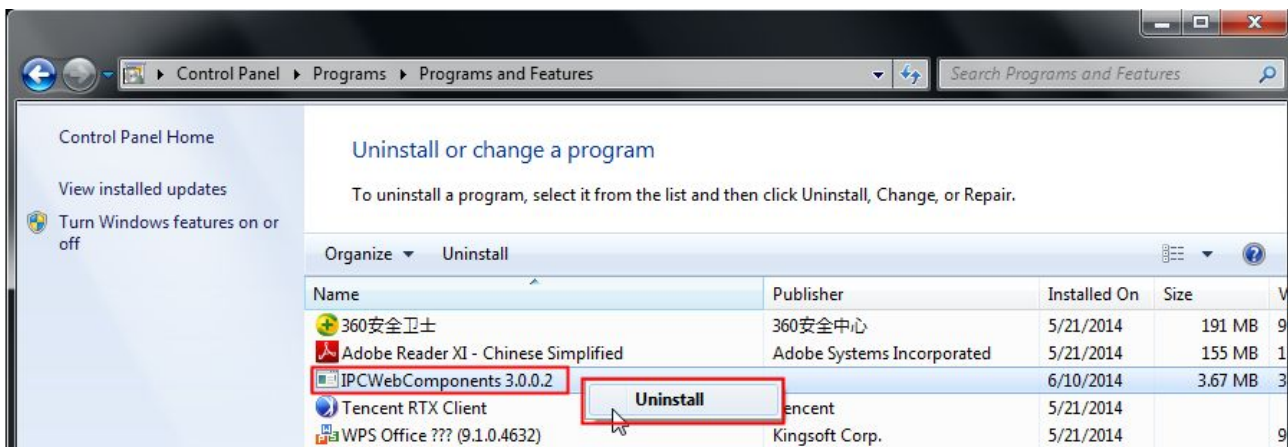
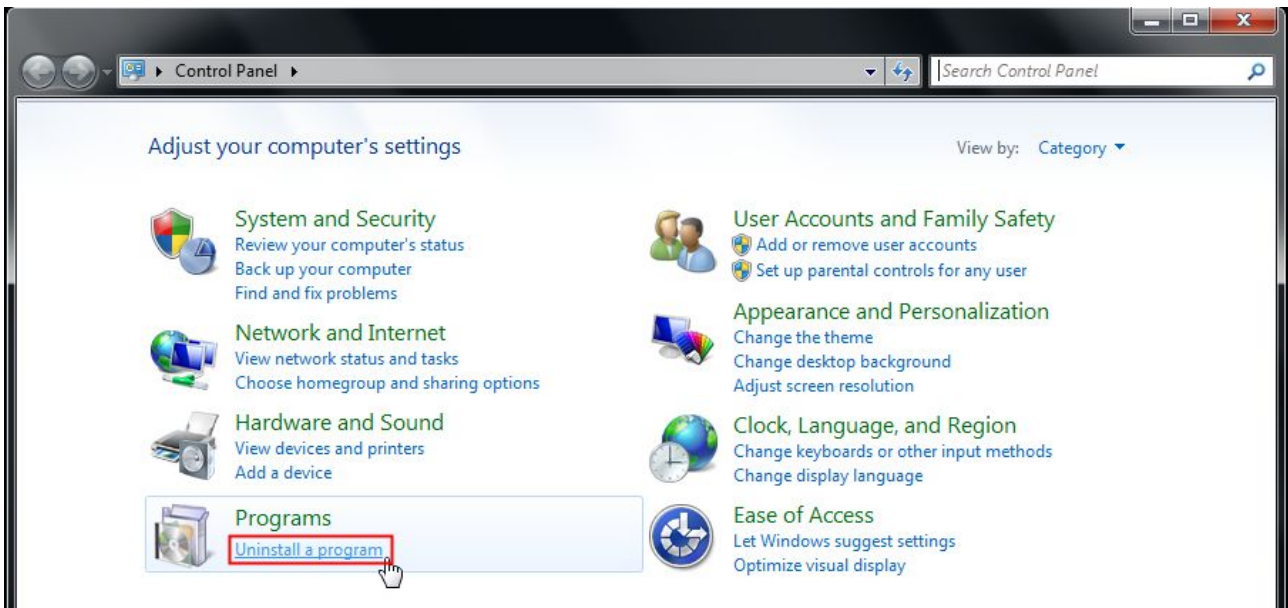

6.1.3 I have forgotten the administrator password

To reset the administrator username and password, press and hold down the RESET BUTTON for 5 seconds. Upon releasing the reset button, wait for 20 seconds, the camera will reboot and the username and password will return to the factory default administrator username and password. Please power on the camera before reset

Default administrator username: admin

Default administrator password: No password

6.1.4 Camera can not record

When you use Windows7 or Vista, you may be not able to do manually record or change the record path because of the security settings of computer.

There are two ways to resolve this problem:

Please add the camera as a trusted site to resolve this issue. The steps are :
IE browser→Tool→Internet Properties→Security→Trusted sites→Sites→Add

Open IE browser, then right click, select “Run as administrator”

6.1.5 Subnet doesn't match

Check whether your ipcamera in the same subnet of your computer. The step is **Control Panel → Network Connections → Dbclick Local Area Connections → Choose General→Properties**.Check subnet mask, IP address and gateways. When you set IP address please make sure they are in the same subnet. Otherwise you can't access camera.

6.1.6 No Pictures Problems

The video streaming is transmitted by the ActiveX controller. If ActiveX controller isn't installed correctly you will see no video image. You can resolve this problem by this way:

Download ActiveX controller and set the safety property of IE in the PC when you view it first time: IE browser→Tool→Internet Proper→Security→Custom Level→ActiveX control and Plug-ins. Three options of front should be set to be “Enable”, The ActiveX programs read by the computer will be stored. As follows:

Enable: Download unsigned ActiveX controls

Enable: Initialize and script ActiveX controls not marked as safe

Enable: Run ActiveX controls and plug-ins

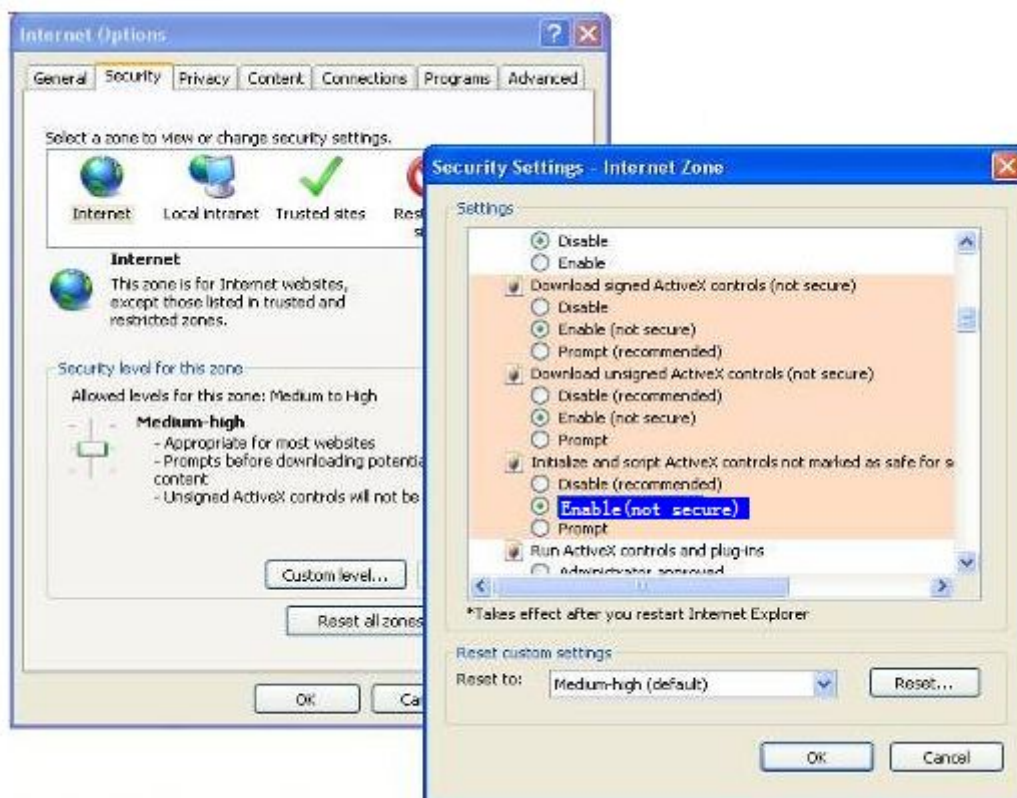

If you allow the ActiveX running, but still could not see living video. Please change another port number to try. Don't use port 88.

Port	
HTTP Port	88
HTTPS Port	443
ONVIF Port	888
RTSP port	554

NOTE: Make sure that your firewall or anti-virus software does not block the camera or ActiveX. If you could not see video, please shut down firewall or anti-virus software to try again.

6.1.7 Can't access IP camera in internet

There are some reasons:

- 1、ActiveX controller is not installed correctly
- 2、The port which camera used is blocked by Firewall or Anti-virus software. Please change another port number and try again.
- 3、Port forwarding is not successful

Check these settings and make sure they are correct.

6.1.8 UPnP always failed

UPnP only contains port forwarding in our recent software. Sometimes, it may be failed to do port forwarding automatically because of firewall or anti-virus software. It also has much relation with router's security settings. So we recommend you do port forwarding manually. You can view your camera in internet successfully after you do port forwarding manually in your router.

6.1.9 Camera can not connect wireless

If your camera could not connect wireless after you set wireless settings and plug out the cable. Please check whether your settings are correct or not.

Normally, camera can't connect wireless mainly because of wrong settings.

Make sure broadcast your SSID; use the same encryption for router and camera.

6.1.10 Can't see other cameras listed in multi-device when using remote access

If you want to view all the cameras via the WAN, verify that each camera added in the multi-device settings can be accessed by using the DDNS name and port number. Use the DDNS domain name not the camera's LAN IP. (For more details see: How to add cameras in WAN)

6.2 Default Parameters

Default network Parameters

IP address: obtain dynamically

Subnet mask: obtain dynamically

Gateway: obtain dynamically

DDNS: Embedded FOSCAM domain name

Username and password

Default admin username: admin with a blank password

6.3 Specifications

Export Models	FI9821P	FI9831P	FI9826P	FI9816P	FI9815P
Image Sensor					
Sensor Type	1/4" CMOS	1/3" CMOS	1/3" CMOS	1/4" CMOS	1/4" CMOS
Display	1.0	1.3	1.3	1.0	1.0
Resolution	MegaPixels(1280*720)	MegaPixels(1280*960)	MegaPixels(1280*960)	MegaPixels(1280*720)	MegaPixels(1280*720)
Integrated ISP	√	√	√	√	√
SDRAM	128MByte	128MByte	128MByte	64MByte	64MByte
Flash	16MByte	16MByte	16MByte	16MByte	16MByte
Frame Rate	30fps	30fps	30fps	25fps (VGA) 23fps (720P)	25fps (VGA) 23fps (720P)
IR-CUT	√	√	√	√	√
Minimum Illumination	0 Lux (With IR Illuminator)	0 Lux (With IR Illuminator)	0 Lux (With IR Illuminator)	0 Lux (With IR Illuminator)	0 Lux (With IR Illuminator)
Lens					
Display Resolution	1.0M Pixels	2.0M Pixels	1.3M Pixels	2.0M Pixels	2.0M Pixels
Lens Type	f:2.8mm, F:2.4	f:2.8mm, F:2.4	f: 3mm~10mm F:1.8	f:2.8mm, F:2.4	f:2.8mm, F:2.4
Angle of View	Horizontal:70° Diagonal :75°	Horizontal:80° Diagonal :95°	Horizontal:35°-100° Diagonal :45°-110°	Horizontal:70° Diagonal :75°	Horizontal:70° Diagonal :75°
Pan and Tilt	H=300°, V=120°	H=300°, V=120°	H=300°, V=100°	H=300°, V=120°	H=300°, V=120°
Night Vision	8m	8m	8m	8m	8m
Connectivity					
Ethernet	√	√	√	√	√
WPS	√	√	√	√	√
Wireless	IEEE 802.11b/g/n	IEEE 802.11b/g/n	IEEE 802.11b/g/n	IEEE 802.11b/g/n	IEEE 802.11b/g/n
Wireless Security	WEP, WPA, WPA2	WEP, WPA, WPA2	WEP, WPA, WPA2	WEP, WPA, WPA2	WEP, WPA, WPA2
EZLink	√	√	√	√	√
P2P	√	√	√	√	√
External I/O	N/A	N/A	N/A	N/A	√
802.3af PoE	N/A	N/A	N/A	N/A	N/A
RS-485 Interface	N/A	N/A	N/A	N/A	N/A

External Card Slot	mirco SD card	mirco SD card	mirco SD card	mirco SD card	mirco SD card
Software Features					
Video Format	H.264, MJPEG	H.264, MJPEG	H.264, MJPEG	H.264	H.264
Multi-Stream	Dual streams	Dual streams	Dual streams	Dual streams	Dual streams
Profile Level	Baseline	Baseline	Baseline	Baseline	Baseline
Motion Detection	√	√	√	√	√
E-mail/FTP Alarm	√	√	√	√	√
Scheduled Recording	√	√	√	√	√
UPnP	√	√	√	√	√
Built-in DDNS Server	√	√	√	√	√
Browser Supported	IE8 and above version ; Firefox; Chrome;Safari.	IE8 and above version ; Firefox; Chrome;Safari.	IE8 and above version ; Firefox; Chrome;Safari.	IE8and above version ; Firefox; Chrome;Safari.	IE8 and above version ; Firefox; Chrome;Safari.
OS Supported	Windows, MAC, Android, iOS	Windows, MAC, Android, iOS	Windows, MAC, Android, iOS	Windows, MAC, Android, iOS	Windows, MAC, Android, iOS
Infrared Mode	Automatic or manual	Automatic or manual	Automatic or manual	Automatic or manual	Automatic or manual
Day/Night	√	√	√	√	√
Firewall	Supports IP Filtering	Supports IP Filtering	Supports IP Filtering	Supports IP Filtering	Supports IP Filtering
User Accounts	Three levels user role	Three levels user role	Three levels user role	Three levels user role	Three levels user role
Audio					
2-Way Audio	√	√	√	√	√
Built-in Microphone	√	√	√	√	√
External Microphone Input	√	√	√	√	N/A
Built-in Speaker	√	√	√	√	√
External Speaker Output	√	√	√	√	N/A
Physical and Environmental					
Waterproof	N/A	N/A	N/A	N/A	N/A

Dimensions (mm)	117(L)x114(W)x129(H)	117(L)x114(W)x129(H)	116(L)*103(W)*122(H) mm	110(L)x 103(W)x 127(H)	110(L)x 103(W)x 127(H)
Net Weight	348g	350g	380g	310g	300g
Power Adapter	5V/2A	5V/2A	5V/2A	5V/2A	5V/2A
Power Consumption	<8.2W	<6.9W	<9W	<7.5W	<5W
Operating Temperature	-10°C ~ 50° (14°F ~ 122°F)	-10°C ~ 50° (14°F ~ 122°F)	-10°C ~ 50° (14°F ~ 122°F)	-10°C ~ 50° (14°F ~ 122°F)	-10°C ~ 50° (14°F ~ 122°F)
Operating Humidity	20% ~ 85% non-condensing	20% ~ 85% non-condensing	20% ~ 85% non-condensing	20% ~ 85% non-condensing	20% ~ 85% non-condensing
Storage Temperature	-20°C ~ 60° (-4°F ~ 140°F)	-20°C ~ 60° (-4°F ~ 140°F)	-20°C ~ 60° (-4°F ~ 140°F)	-20°C ~ 60° (-4°F ~ 140°F)	-20°C ~ 60° (-4°F ~ 140°F)
Storage Humidity	0% ~ 90% non-condensing	0% ~ 90% non-condensing	0% ~ 90% non-condensing	0% ~ 90% non-condensing	0% ~ 90% non-condensing
Reset	Reset button is available	Reset button is available	Reset button is available	Reset button is available	Reset button is available
Certification	IC, CCPSA, CSA, CE, FCC, RoHS	IC, CCPSA, CSA, CE, FCC, RoHS	IC, CCPSA, CSA, CE, FCC, RoHS	CE, FCC, RoHS	CE, FCC, RoHS
warranty	Limited 2-year warranty	Limited 2-year warranty	Limited 2-year warranty	Limited 2-year warranty	Limited 2-year warranty

Attention: Power adapter should be used between 0°C-40°C, and 5%-90% relative humidity.

6.4 CE & FCC

Electromagnetic Compatibility (EMC)

FCC Statement



This device complies with FCC Rules Part 15. Operation is subject to the following two conditions.

- This device may not cause harmful interference
- This device must accept any interference received, including interference that may cause undesired operation.

This equipment has been tested and found to comply with the limits for a Class B digital device, pursuant to Part 15 of the FCC Rules. These limits are designed to provide reasonable protection against harmful interference when the equipment is operated in a commercial environment. This equipment generates, uses, and can radiate radio frequency energy and, if not installed and used in accordance with the installation manual, may cause harmful interference to radio communications. Operation of this

equipment in a residential area is like to cause harmful interference, in which case the user will be required to correct the interference at his own expense.

FCC Caution

Any changes or modification not expressly approved by the party responsible for compliance could void the user's authority to operate this equipment.

This equipment complies with FCC radiation exposure limits set forth for an uncontrolled environment. This equipment should be installed and operated with minimum distance 20cm between the radiator& your body.

This transmitter must not be co-located or operating in conjunction with any other antenna or transmitter.

CE Mark Warning



This is a Class B product. In a domestic environment, this product may cause radio interference, in which case the user may be required to take adequate measures.

6.5 Warranty

ShenZhen FOSCAM Intelligent Technology Limited.("FOSCAM") values your business and always attempts to provide you the very best of service.

No limited hardware warranty is provided by FOSCAM unless your FOSCAM product ("product") was purchased from an authorized distributor or authorized reseller. Distributors may sell products to resellers who then sell products to end users. No warranty service is provided unless the product is returned to an authorized return center in the region where the product was first shipped by FOSCAM or to the point-of-purchase, which may have regional specific warranty implications.

If you purchase your FOSCAM product from online store, please contact the point-of-purchase and ask for return/replacement/repair service.

Hardware Warranty Information

FOSCAM provide 2-year limited warranty for naked product and 6-month limited warranty for accessories.

Limited Hardware Warranty

- FOSCAM products are warranted to be free from manufacturing defects in materials and workmanship starting from the shipping date of FOSCAM.

This limited hardware warranty does not cover:

- Software, including the software added to the products through our factory-integration system, software that included in the CD,etc.
- Usage that is not in accordance with product instructions.
- Failure to follow the product instructions.

- **Abuse firmware upgrade without the authorized technician's guidance.**
- **Normal wear and tear.**

Return Procedures

- Please read FOSCAM warranty policy & policy of your reseller first before sending items back to point-of-purchase.
- Customer must first contact point-of-purchase to obtain a Return Merchandise Authorization (RMA) number before returning the product. If the product you received is suspected to be defective and the product warranty has not expired, The RMA number will allow your reseller to track your return much easier and help them expedite processing your request.
- After receiving your RMA case number, pack the item(s) very well with the original box and all the original accessories included such as power adapters, brackets, cables, manuals, and driver CD disks.
- Write your RMA number and the return reason (the problem of the product) on the warranty card along with the complete package to send them back.

Replacement Services

- **If customers ask for replacement service, please contact point-of-purchase and follow their policy.**
- Our technicians will inspect all items returned for replacement requests. If the returned product is found in working order, we will return the same item received. However customers shall be responsible for all shipping & handling charges incurred for getting the units back to customers.
- If returned products are found defective, we will replace the product and assume the shipping cost for sending back the replacement unit to customers.
- If for any reason, we are unable to provide a replacement of the original returned item(s). You will have a choice for a "Substitute" item at the same equal value.
- We do not provide exchange and replacement due to normal hardware upgrade according the market after 14 days after the product is delivered.
- Our technicians will test the product before send out the replacement, any other demand for more than two times replacement for the same product during replacement limit will be rejected.
- **Replaced products are warranted from the balance of the former warranty period.**

Warranty Forfeiture

- Warranty is void if purchase from unauthorized distributor or reseller.
- Warranty is void if trade-mark, serial tags, product stickers have been removed, altered or tampered with.
- Warranty is void for mishandling, improper use, or defacing the product.
- **Abuse firmware upgrade without the authorized technician's guidance.**
- Warranty is void for physical damage, altered, either internally or externally, improper or inadequate packaging when returned for RMA purposes.
- Warranty is void if damage has resulted from accident, dismantle, abuse, or service or modification by someone other than the appointed vendor, source, fission or the spare part has been over the period of warranty.

- Warranty is void if product is damaged due to improper working environment or operation. (For example, improper temperature, humidity, unusual physical or electrical stress or interference, failure or fluctuation of electrical power, static electricity, using wrong power adapter, etc.)
- Warranty is void if damaged by the use of parts not manufactured or sold by FOSCAM.
- Damage caused by improper installation of third-party products.
- Warranty is void if damaged for irresistible cause, such as earthquake, fire, lightning, flood, etc.
- Product beyond limited warranty.

Shipping Fee

- If products are defective or damaged under normal use or operation in the replacement limit, distributors or resellers are responsible for the shipping cost the product back to customers, customers should assume the shipping cost send the product to the point-of-purchase.
- During replacement limit, if customers ask for replacement due to the product does not fit for customer's personal expectation, customers should responsible for both shipping fee.
- Customers shall be responsible for both shipping fee if their product beyond the replacement limit but still in warranty limit.

Repair Service Out Of Warranty

- FOSCAM provide extra repair service for product that out of warranty, it is chargeable. The total fee contains device cost and service fee. Device cost (including accessories) is the standard uniform price provide by FOSCAM.
- Different region may have different service fee, please contact the point-of-purchase to confirm that before you ask for this service.
- Our technicians will quote the total price after detect the product, If customers refused to repair after the quotation, customers need pay for the test fee, \$3.5/hour. If agree with the quotation, test will be free.
- Repaired product out of warranty will obtains 3-month warranty from the date of the product back to customers.

Limitation of Liability

- FOSCAM is not responsible for other extra warranty or commitment promised by resellers, if your reseller promised some extra commitment or warranty; please ask for written documents to protect your rights and interests.
- FOSCAM does not offer refunds under any circumstances. Please contact the point-of-purchase and follow their refund/return policy.
- FOSCAM shall not be liable under any circumstances for any consequential, incidental, special or exemplary damages arising out of or in any connection with this agreement or the products, including but not limited to lost profits, or any claim based on indemnity or contribution, or the failure of any limited or exclusive remedy to achieve its essential purpose or otherwise. Purchaser's exclusive remedy, as against FOSCAM, shall be the repair or replacement of defective parts. If FOSCAM lists a product on its website specification in error or that is no longer available for any reason, FOSCAM reserves the right to explain it without incurring any liability.

All rights reserved. FOSCAM and the FOSCAM logo are trademarks of ShenZhen FOSCAM Intelligent Technology Limited., registered in the U.S. and other countries.

7 Obtaining Technical Support

While we hope your experience with the IPCAM network camera is enjoyable and easy to use, you may experience some issues or have questions that this User's Guide has not answered.

If you have problem with FOSCAM IP camera, please first contact FOSCAM reseller for solving the problems. If our reseller cannot provide service, please contact our service department: tech@foscam.com

