



31220

THE
MET



Available in English
In deutscher Sprache verfügbar
Disponibles en français
Disponibile in italiano
Disponible en español
提供中文版本



LEGO® Builder

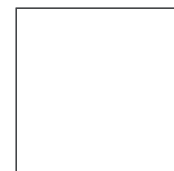



LEGO.com/sustainable-packaging



FR
DONNEZ
OU
RECYCLEZ



ASSOCIATION

OU



MAGASIN

OU



DÉCHÈTERIE

Adresses sur quefairedemesdechets.fr



BUILDER



Apple and the Apple logo are trademarks of Apple Inc., registered in the U.S. and other countries and regions. App Store is a service mark of Apple Inc. Google Play and the Google Play logo are trademarks of Google LLC. Tencent and the Tencent logo are trademarks of Tencent Inc.

LEGO.com/devicecheck



LEGO® Builder

WELCOME TO LEGO® ART

To create a masterpiece, you must challenge convention, trust the process and allow your idea to form, little by little. Claude Monet (1840–1926) once said, “Merely think, here is a little square of blue, here an oblong of pink, here a streak of yellow... until it gives your own naïve impression of the scene before you.” We couldn’t think of a more appropriate introduction to LEGO® Art.



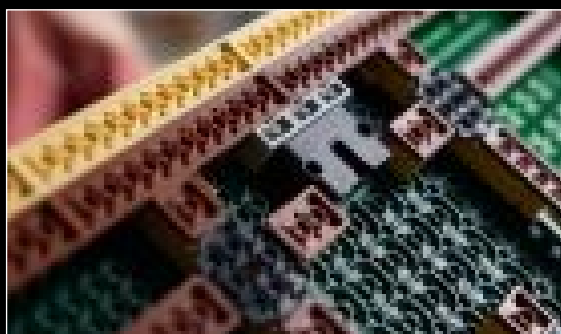

BUILDING PROCESS

Claude Monet cultivated his water-lily pond "for the pleasure of the eye and also for motifs to paint". Few motifs are as widely recognised as his water lilies. With LEGO® Art, you can now retrace the strokes of a great painter.



Claude Monet (1840–1926) in his garden at Giverny



Bridge over a Pond of Water Lilies. Claude Monet (French, 1840–1926). Oil on canvas, 92.7 x 73.7 cm., 1899. H. O. Havemeyer Collection, Bequest of Mrs. H. O. Havemeyer, 1929 29.100.113

THE BEAUTY OF THE FLEETING MOMENT

The French artist Claude Monet is synonymous with Impressionism. Beginning in the 1860s, he developed an innovative style of flickering strokes of vivid colour to suggest the changing effects of light and motion. *Bridge over a Pond of Water Lilies* captures Monet's profound creative connection with the water garden that he built near his home in Giverny outside of Paris. The painting is one of a series of eighteen views from 1899 and 1900 depicting the pool from the same vantage point. Layers of feathery brushwork in delicate hues of green and blue evoke slender willows and rounded water lilies, which are mirrored in the pond. The arched footbridge and its reflection contrast with the soft greenery and shimmering water.



*"My garden is my
most beautiful masterpiece."*

- Claude Monet

CLAUDE MONET'S GARDEN AT GIVERNY

In 1883, Claude Monet moved to Giverny, a village near Paris, which offered the space and tranquillity to pursue both his landscape painting and his serious passion for gardening. Over the years, he gradually expanded and reshaped the property into his personal retreat and artistic sanctuary, with a variety of plants and scenery. Inspired in part by Japanese art and garden design, he introduced exotic plants and trees, added a footbridge and diverted a stream to enlarge his water-lily pond. Giverny was Monet's laboratory to explore the beauty of light, colour, weather and the seasons. The garden became his major subject, inspiring hundreds of paintings and stimulating his constant innovation. The artist's home and garden at Giverny are now a dedicated museum.

Monet's artwork
displayed at
The Met



WELCOME TO THE MET

The Metropolitan Museum of Art in New York displays tens of thousands of objects covering 5,000 years of art from around the world for everyone to experience and enjoy. The Museum is organised into 19 curatorial departments, including European Paintings. Established in 1871 with 174 paintings, the European Paintings collection now features over 2,500 works of art from the thirteenth to the early twentieth century. Among the highlights is Claude Monet's iconic *Bridge over a Pond of Water Lilies*. Combining classic LEGO® elements in creative constellations offers a playful approach to the discovery of this beloved work. The LEGO team had a fantastic time visiting the Museum, where we explored the painting in depth with the help of Met experts.



The Metropolitan
Museum of Art,
New York

FROM THE LEGO® ART DESIGN TEAM

The pioneer of Impressionism, Claude Monet now makes a long-awaited addition to our LEGO® Art collection. His distinctive brushwork ranges widely in colour, shape, texture and orientation. When we create a model with this many different elements, we direct a lot of our attention to the building experience, making sure that it's as intuitive as possible, and drawing you into the creative process of an Impressionist painting. You'll be using many elements that represent Monet's style, and there is a fun rhythm to the build as you alternate between techniques and see the image take shape.





LISTEN

Scan the QR code to go behind the scenes with the LEGO® Art designers, and learn about Claude Monet, in a podcast created in collaboration with experts from The Metropolitan Museum of Art, New York.

BUILD

Experience a familiar work of art from new perspectives and discover playful ways to create your own art.

RELAX

Immerse yourself in Monet's vibrant world and feel your creativity flourish.



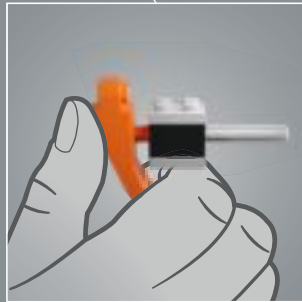
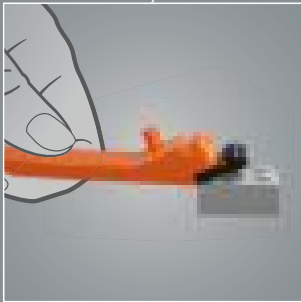
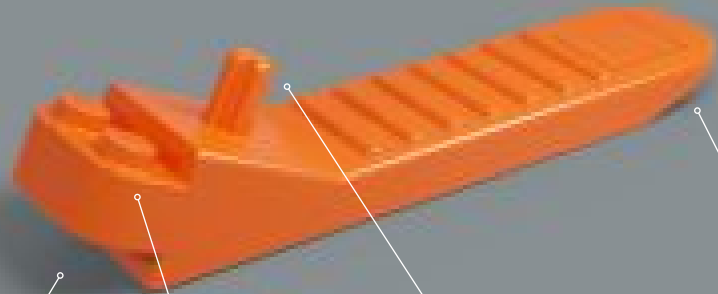

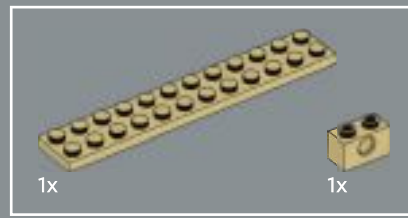

1

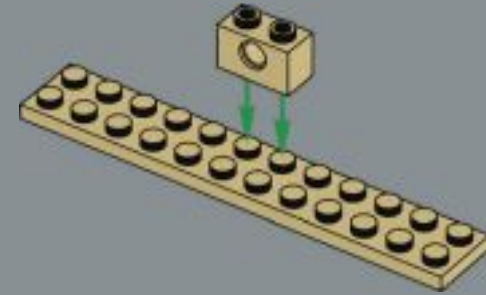

2

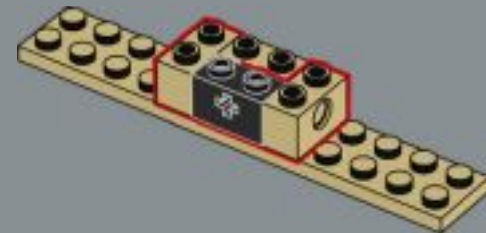

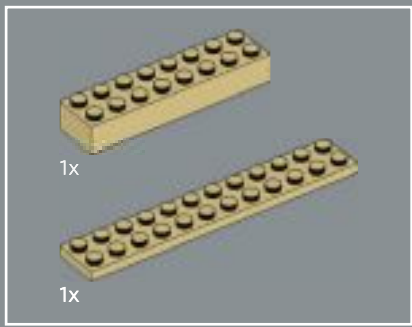

3

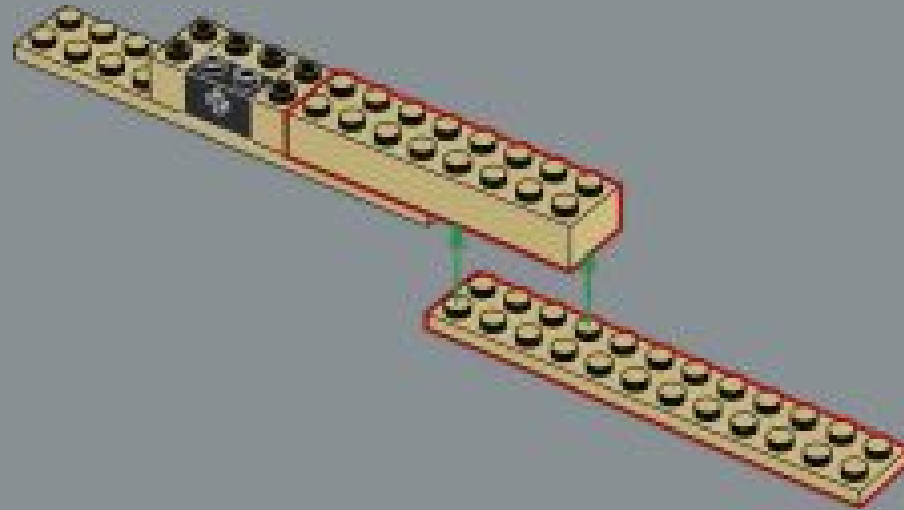

4

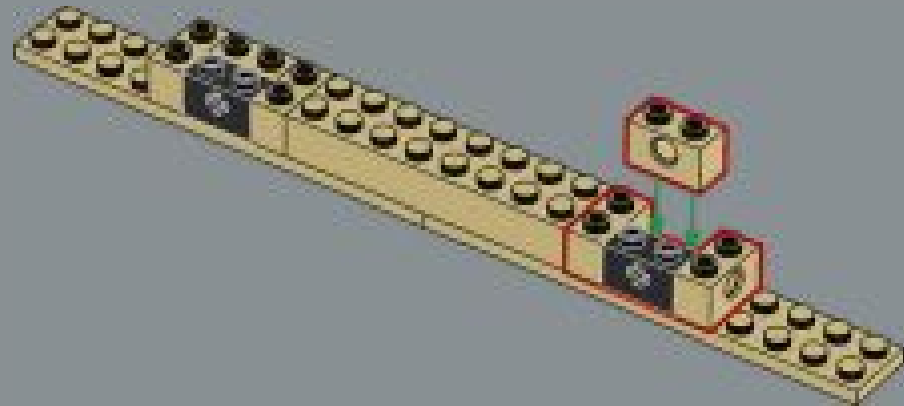



5

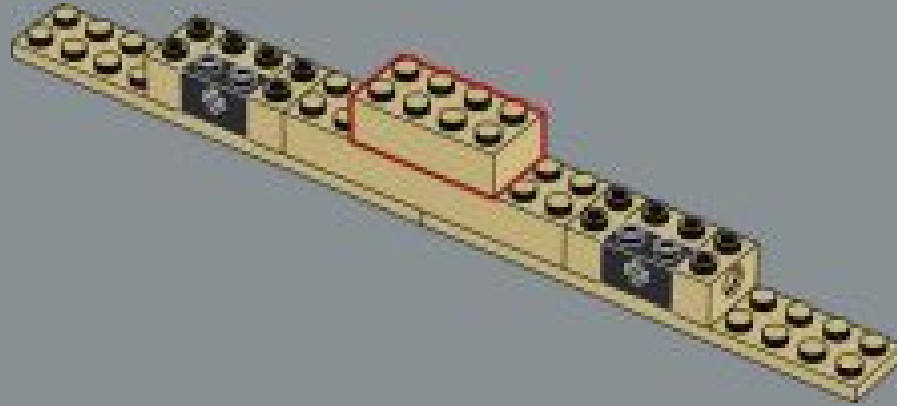

6

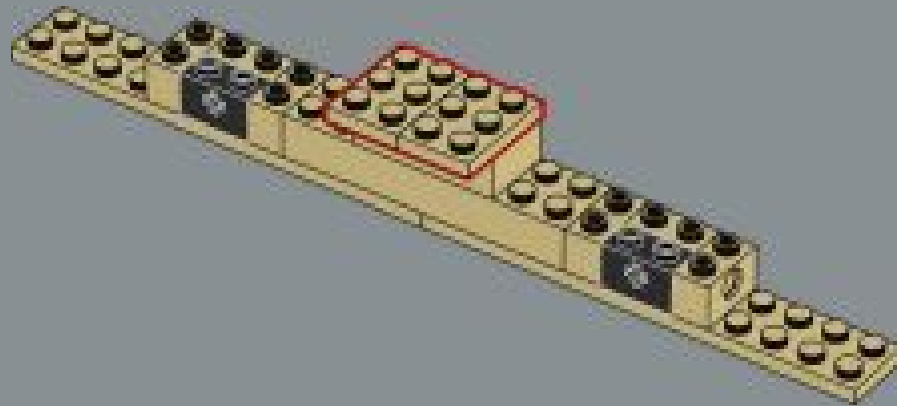

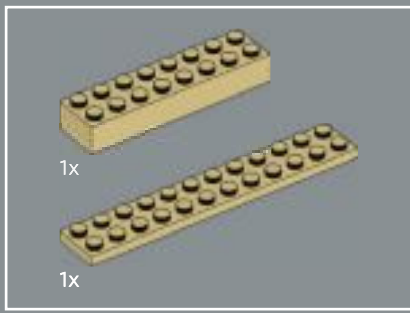

7

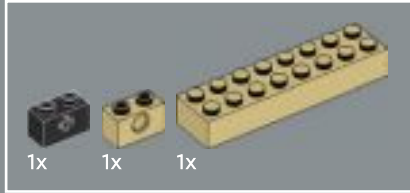
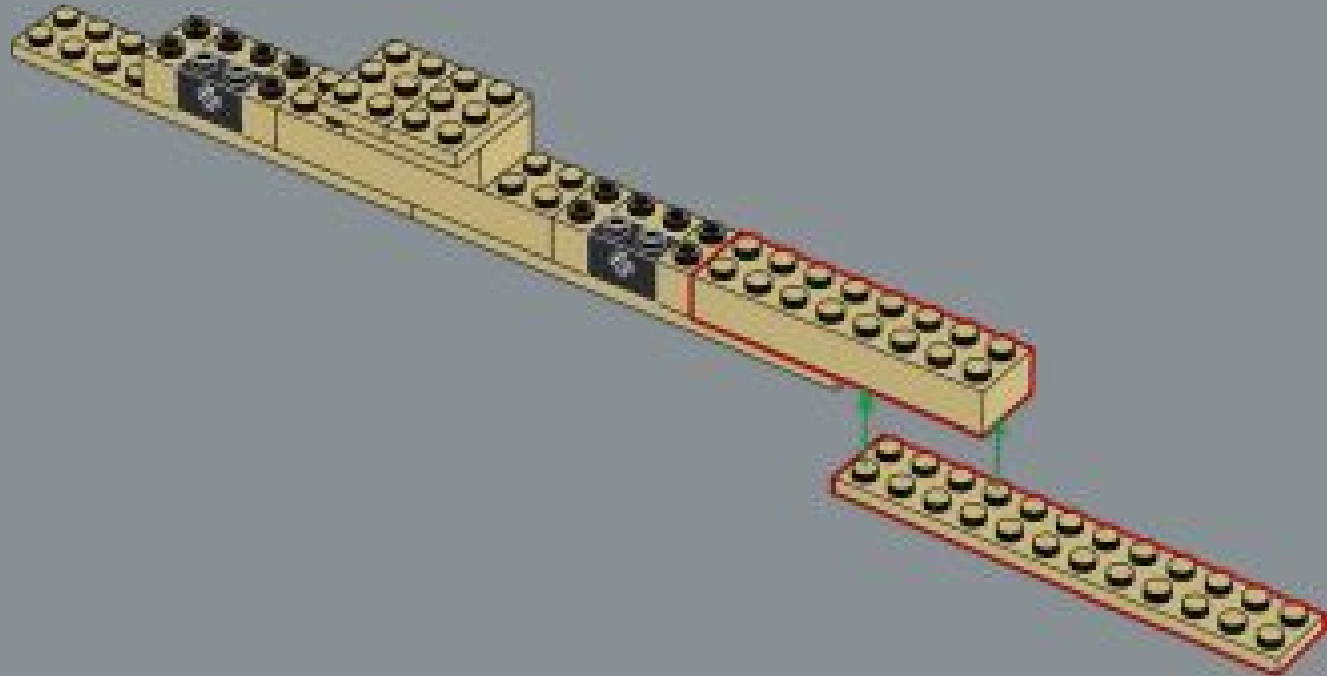

8

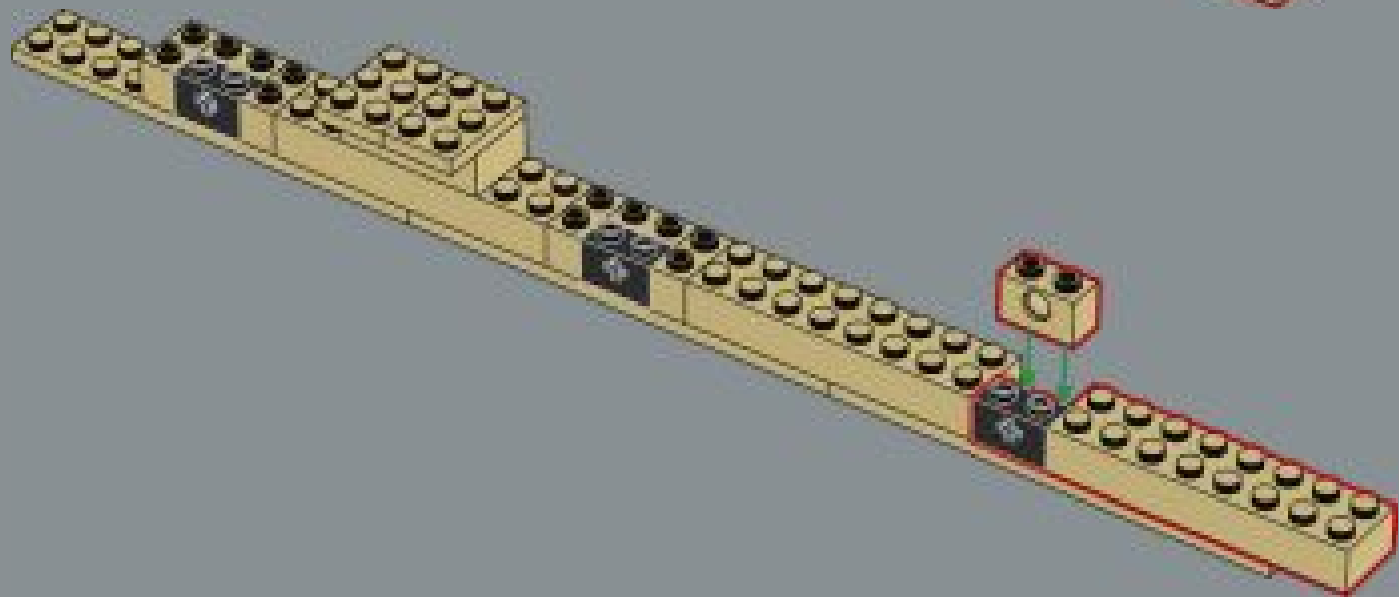

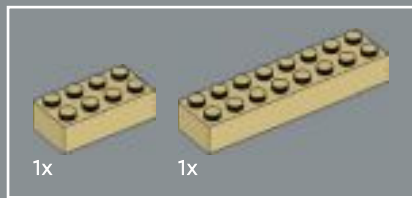

9

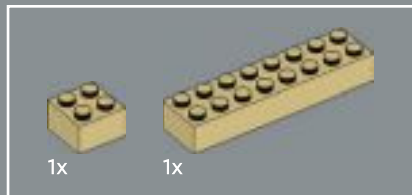
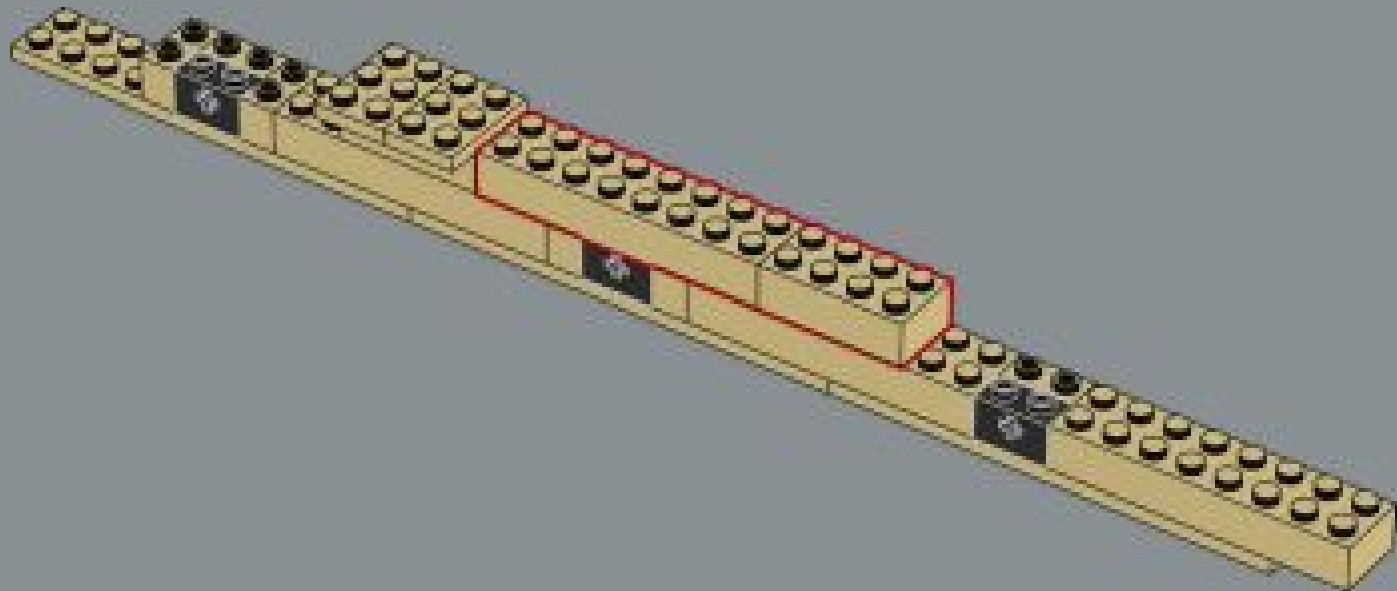

10

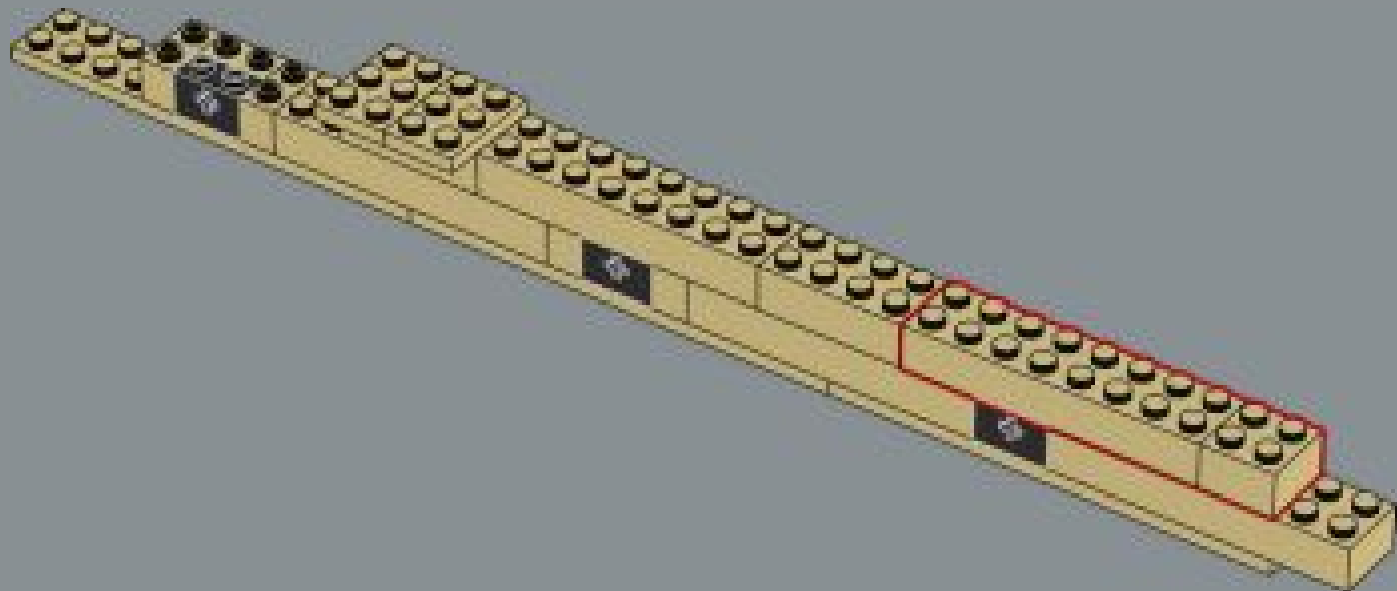

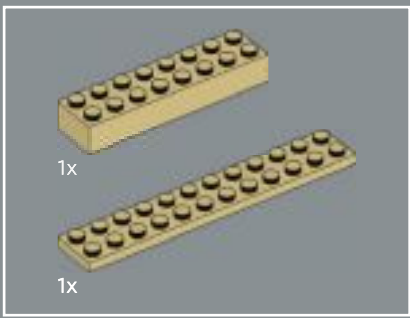

11

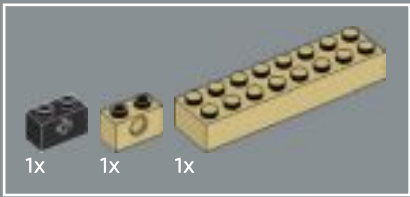
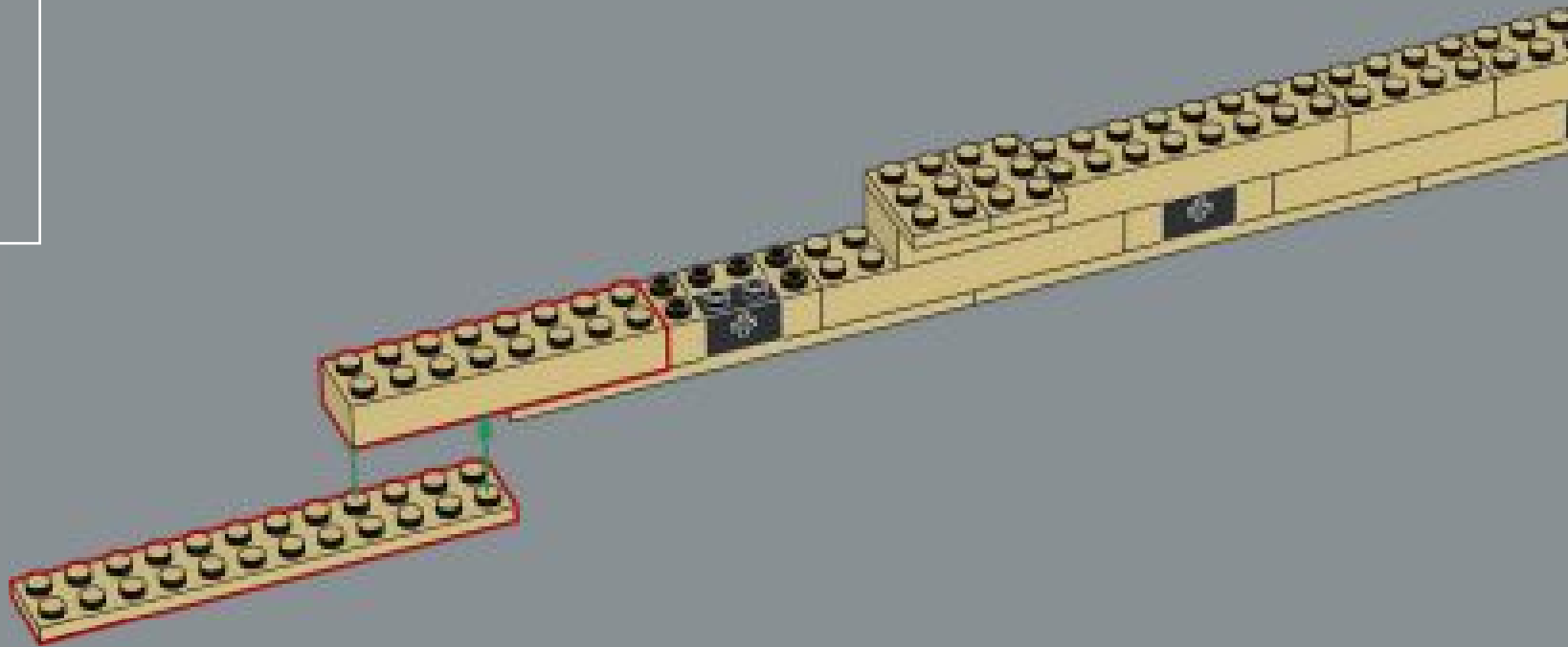

12

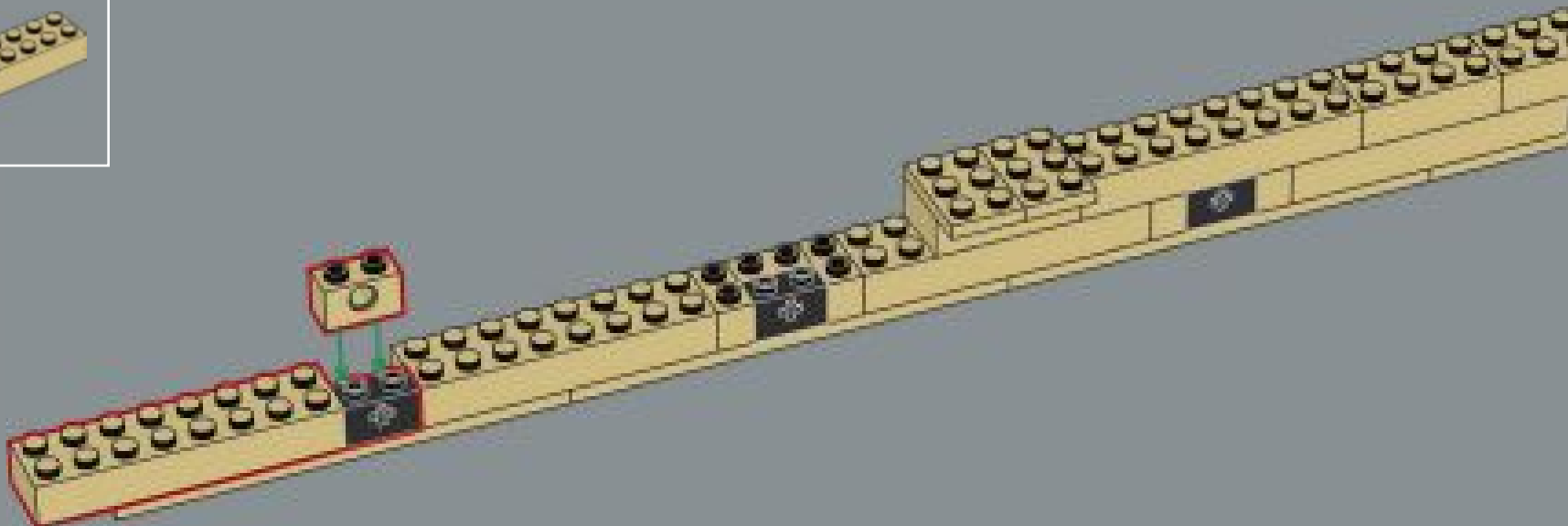

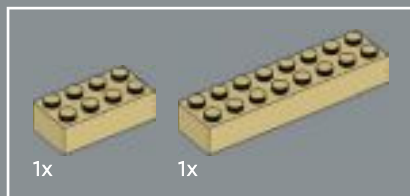

13

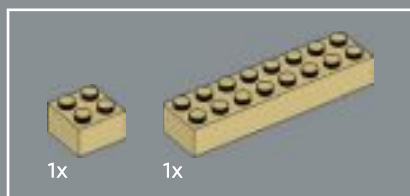
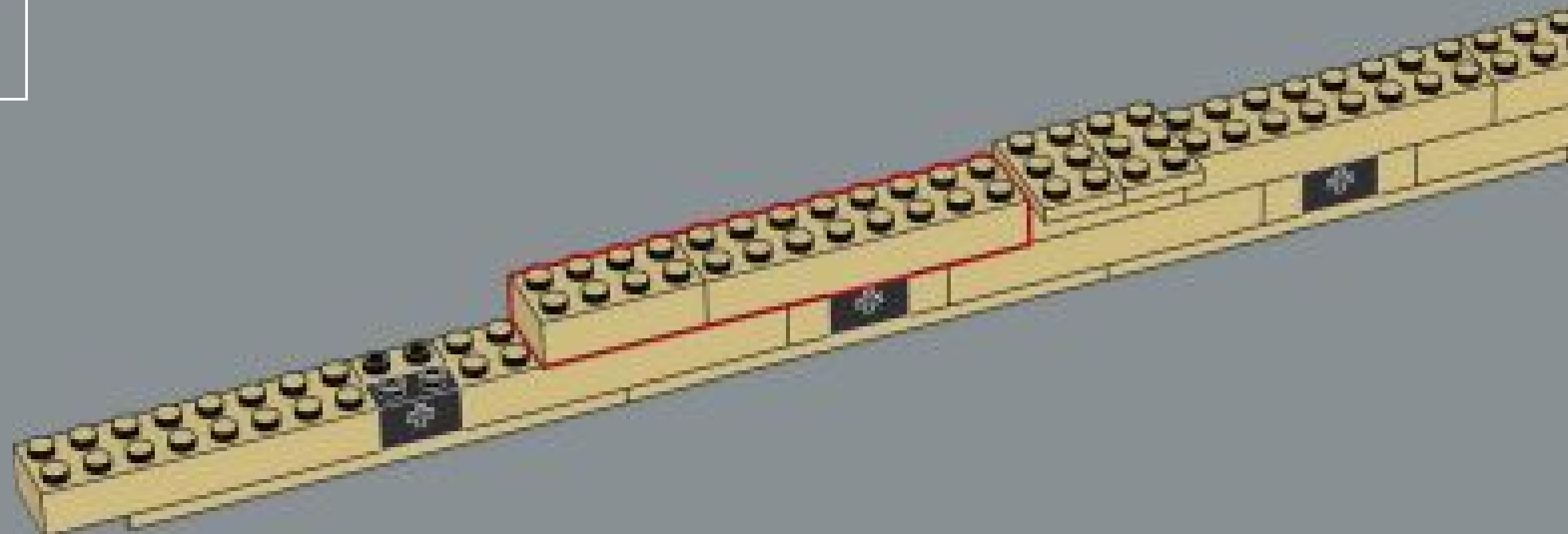

14

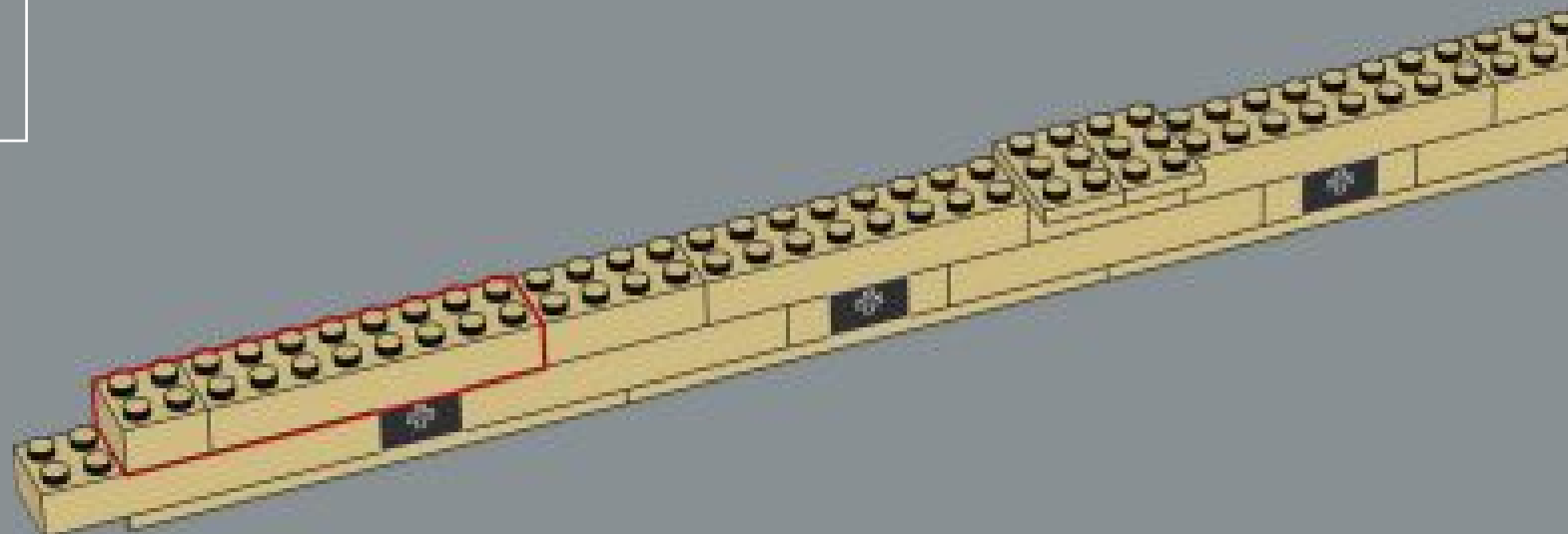

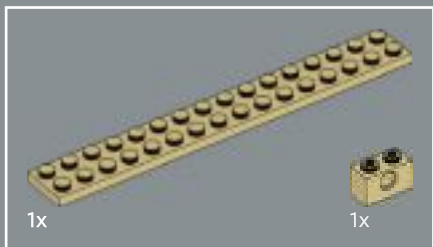

15

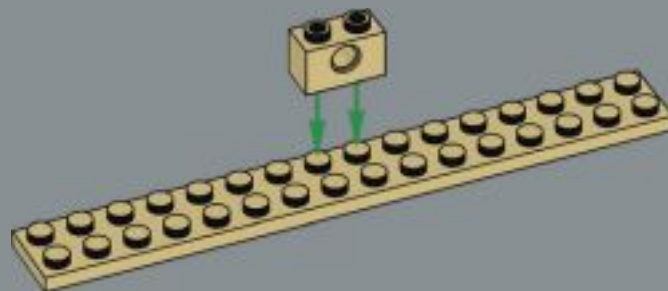



16

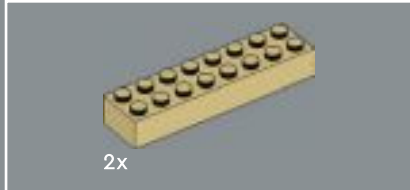
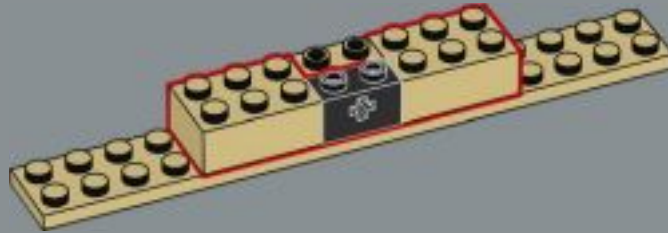

17

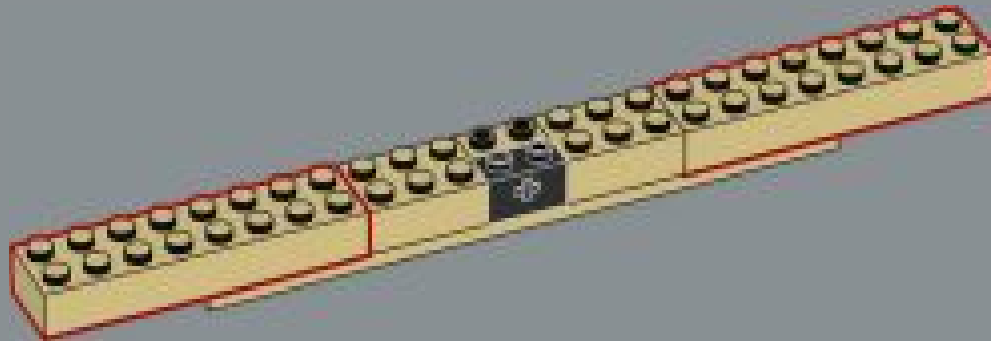

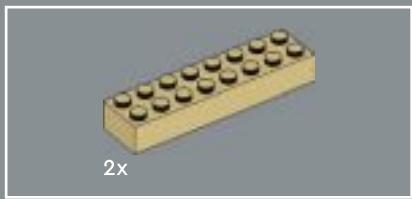

18

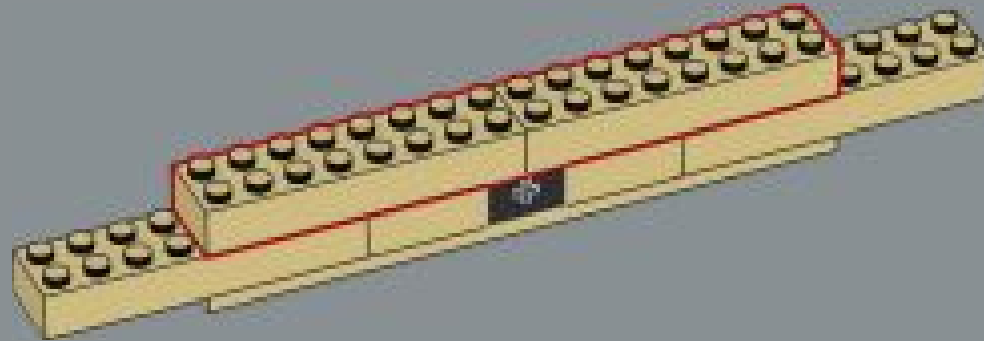

19

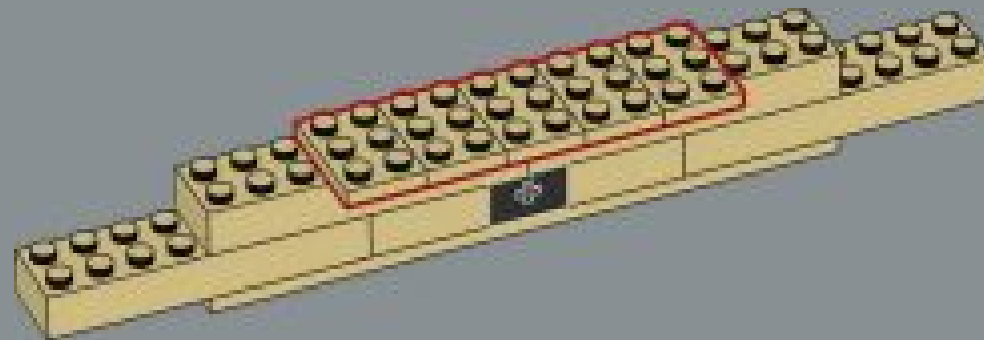

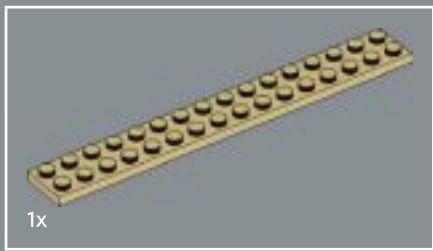

20

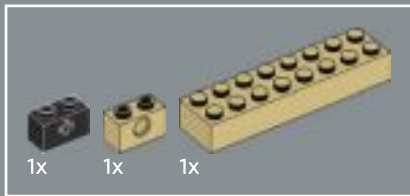
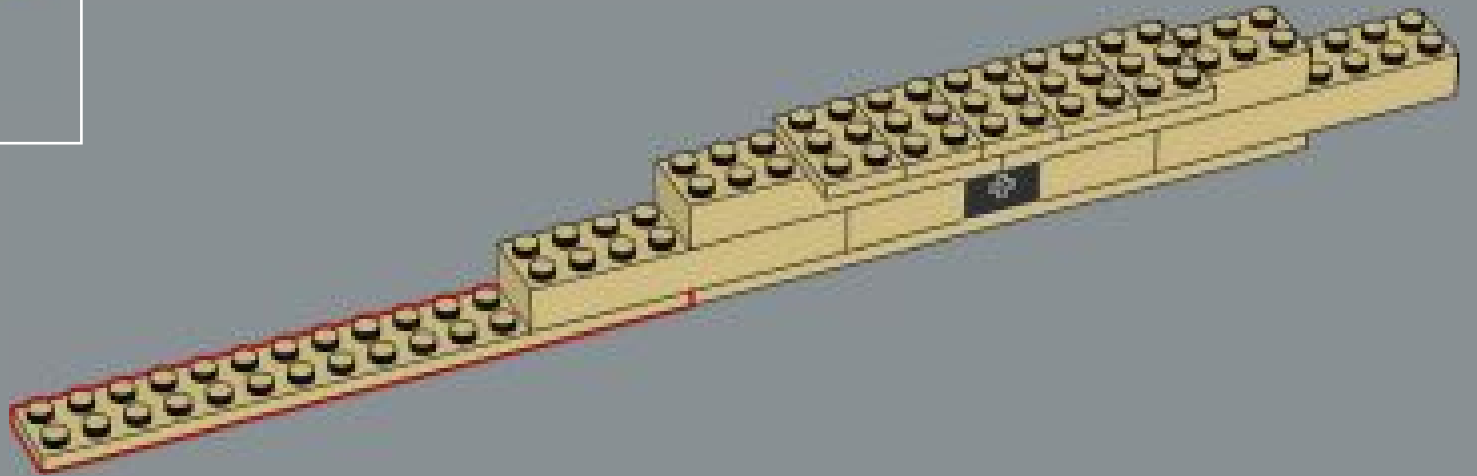

21

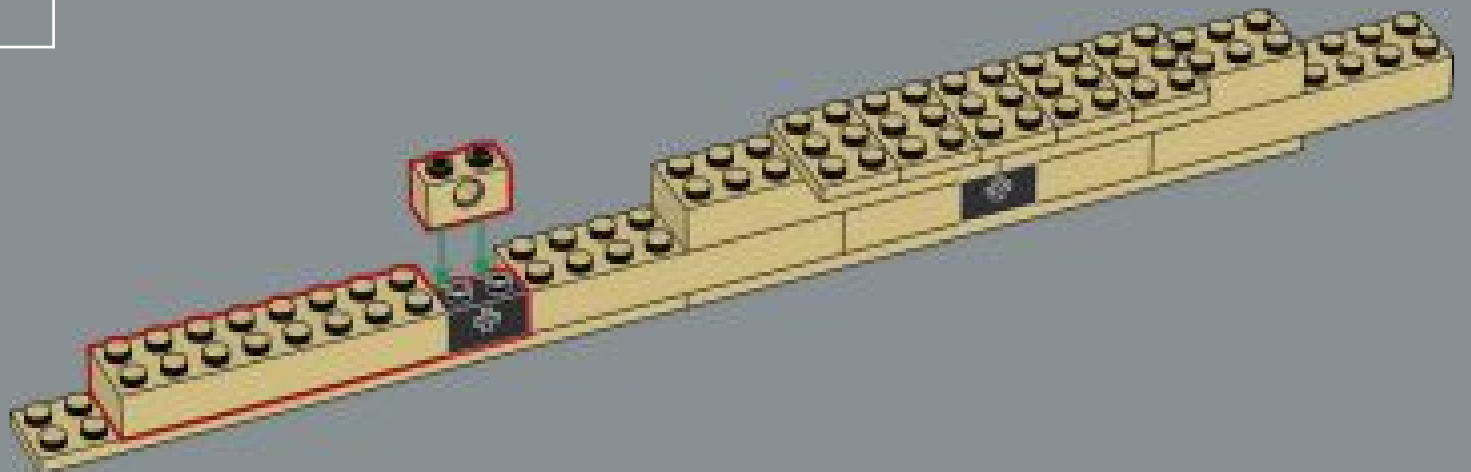

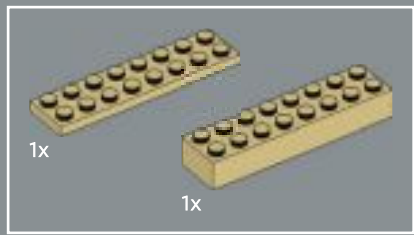

22

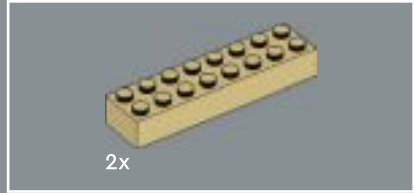
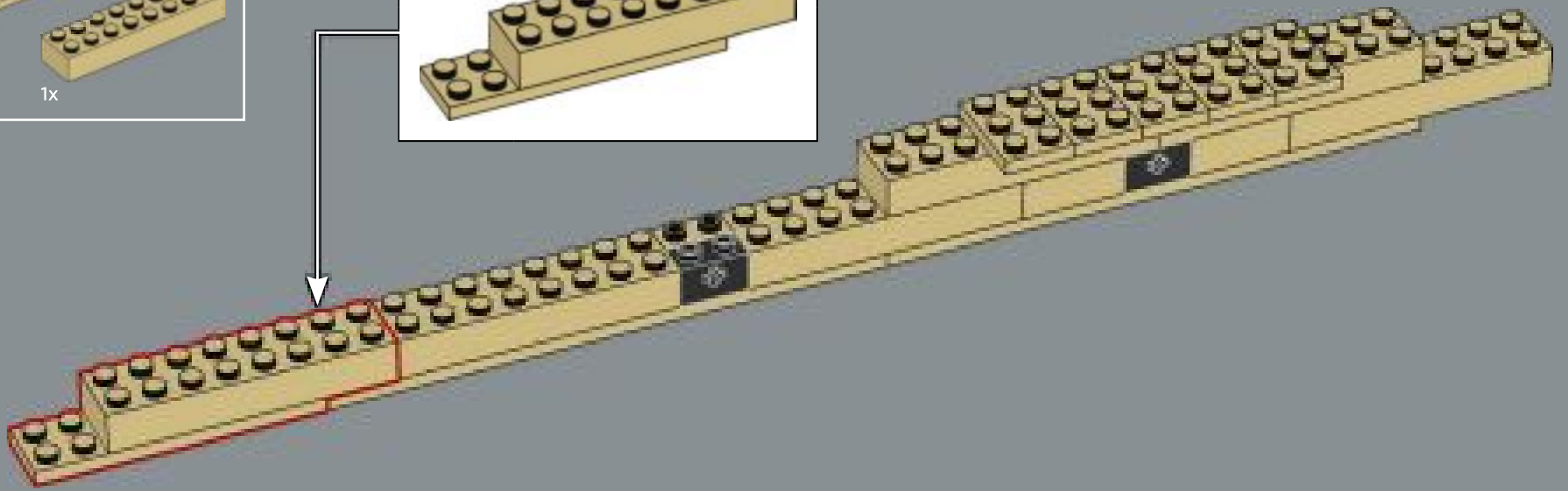
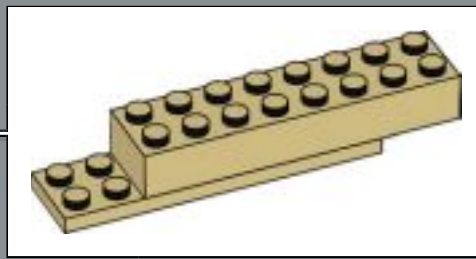

23

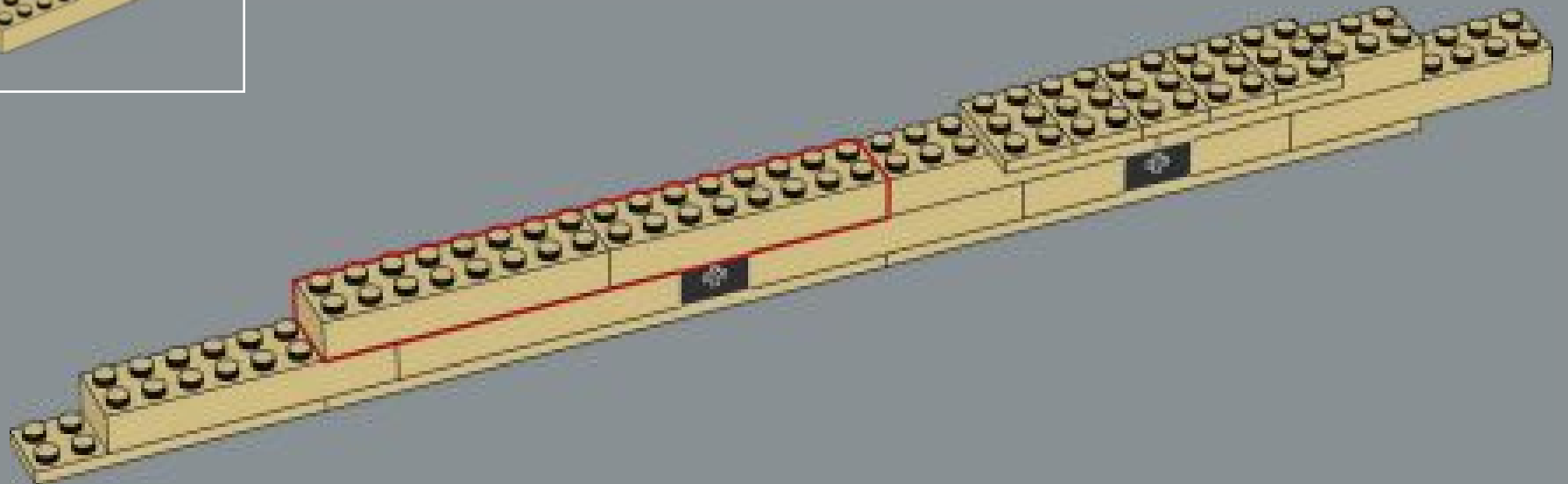

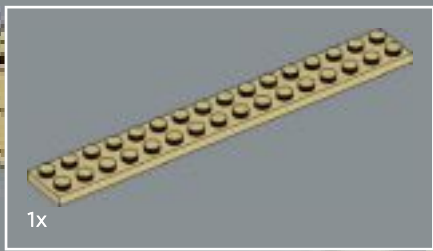

24

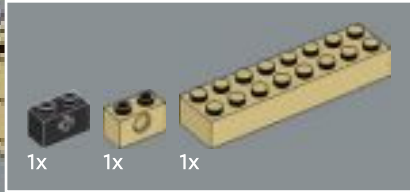
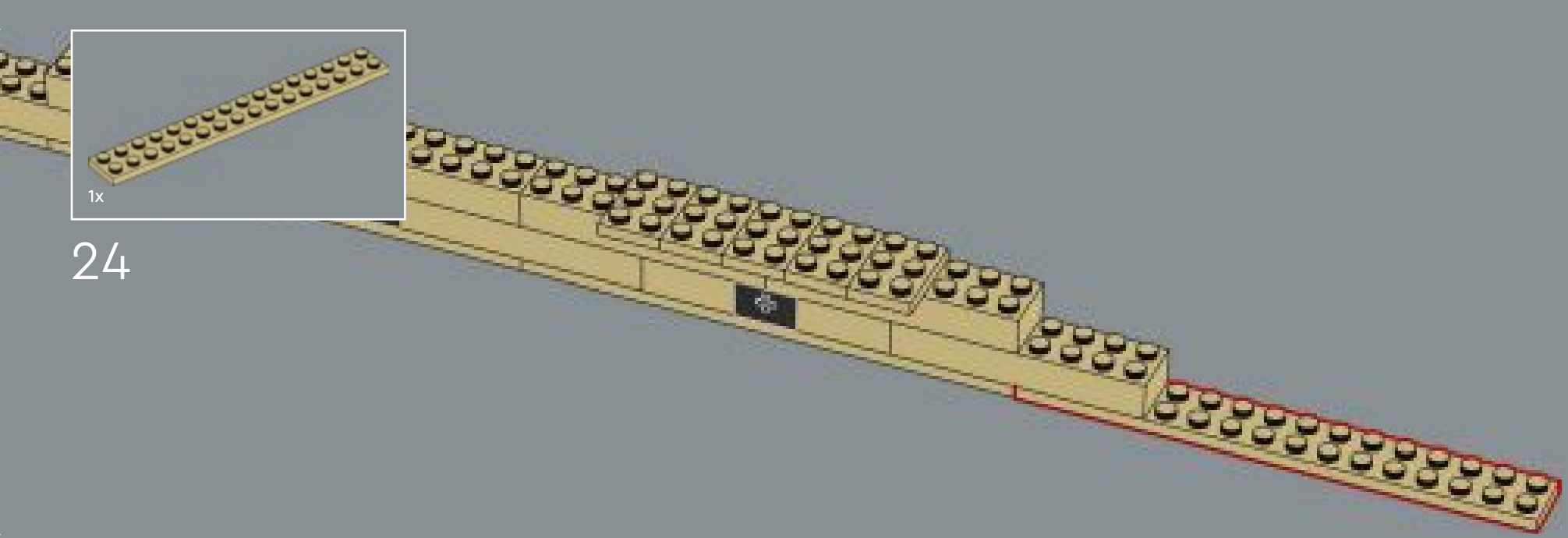

25

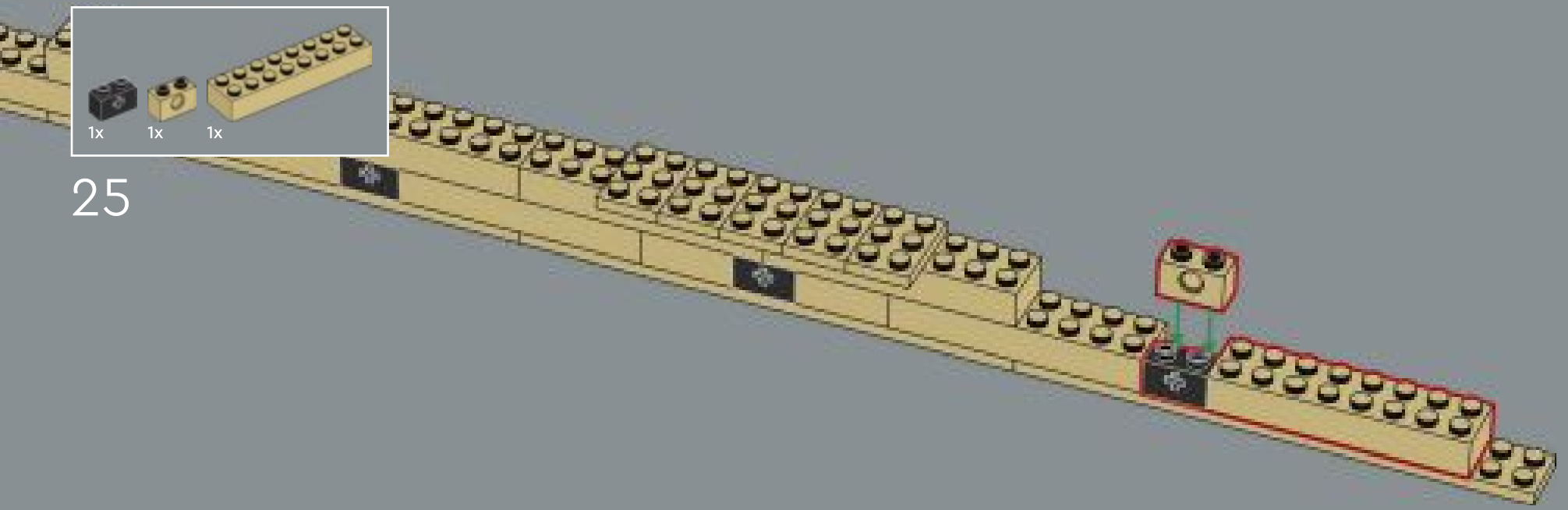

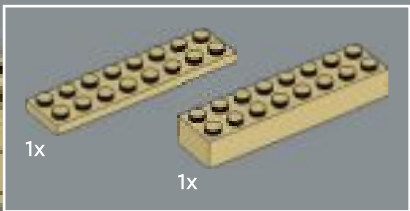

26

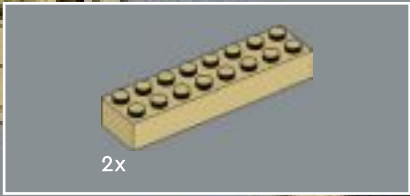
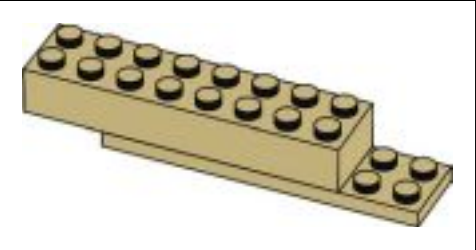

27

2x

28

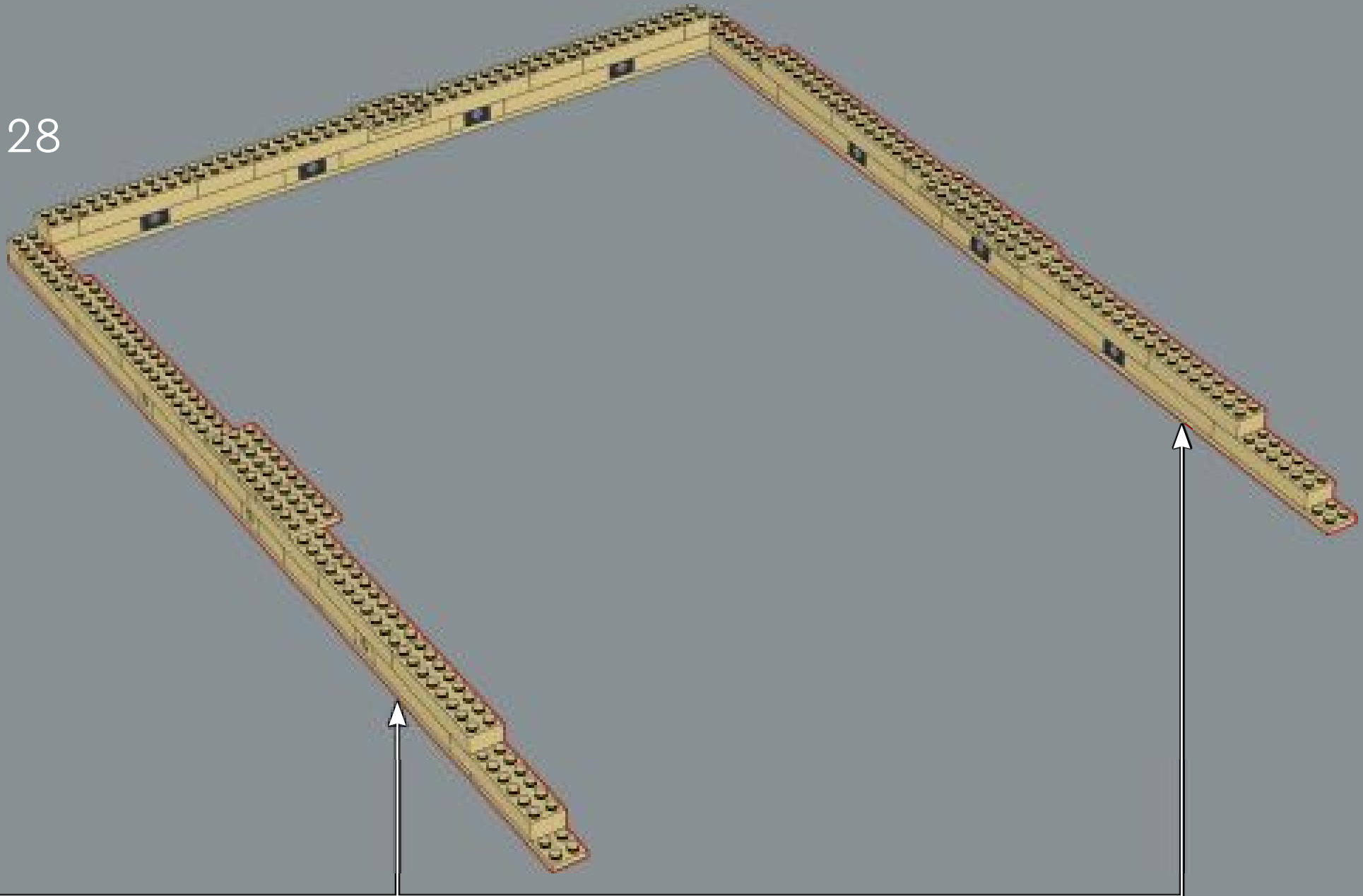

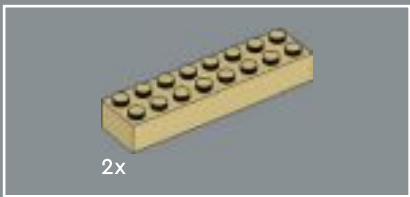

29

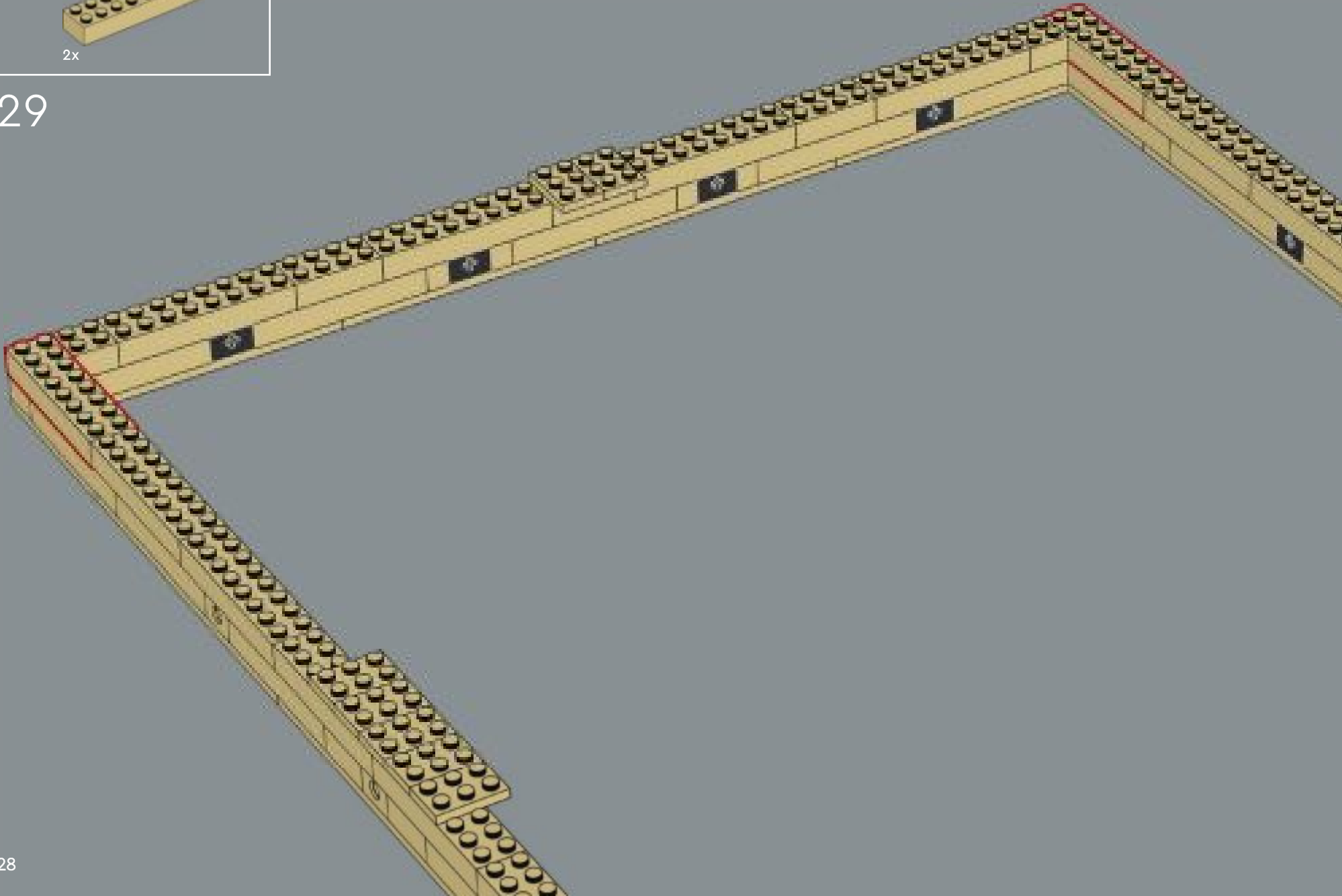

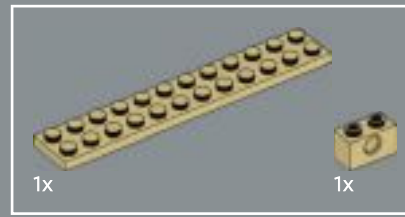
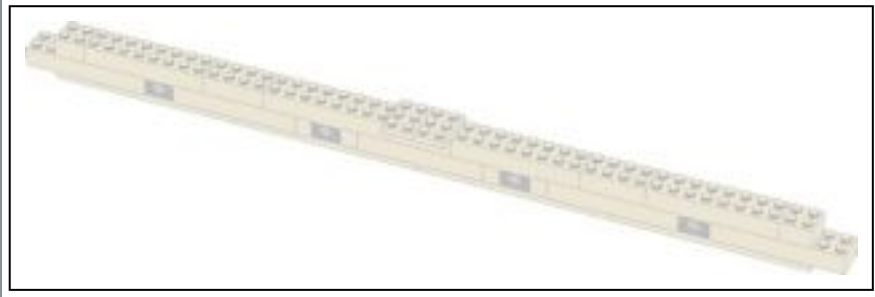

30

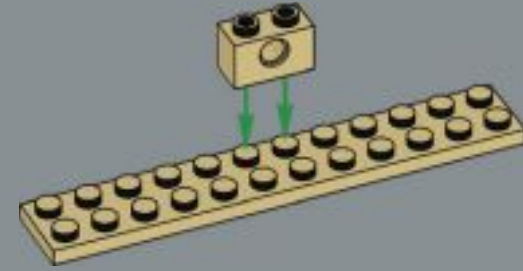

31



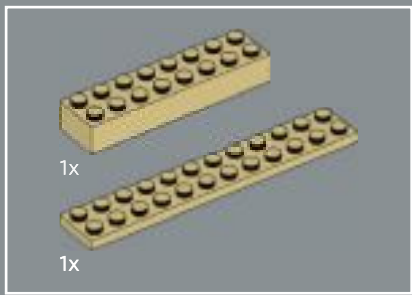

32

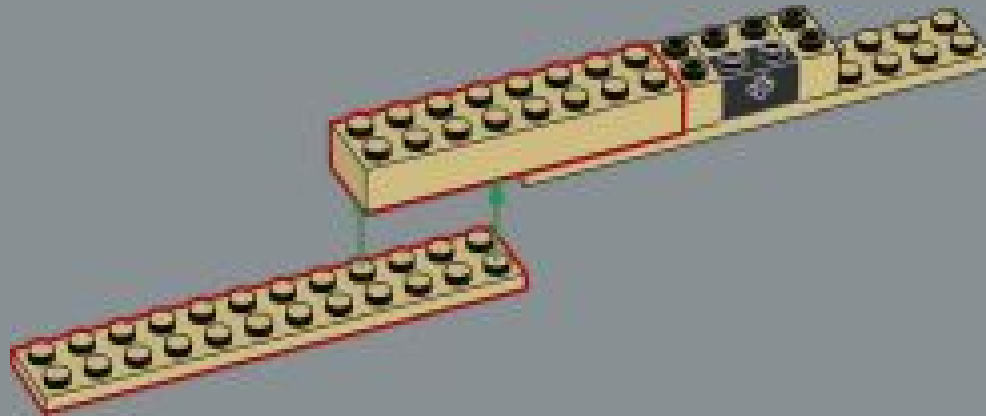

33

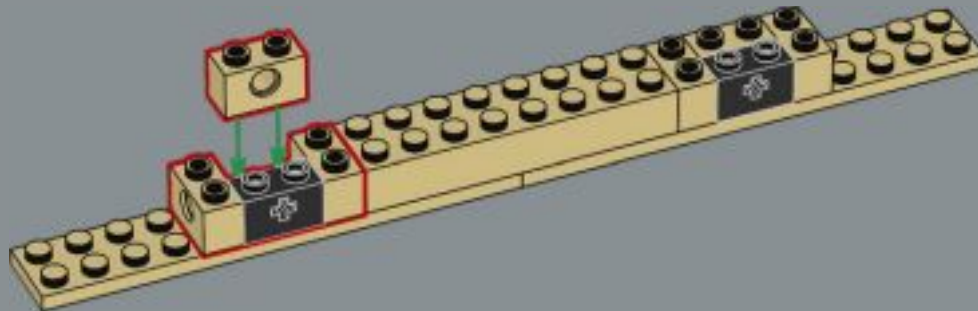



34

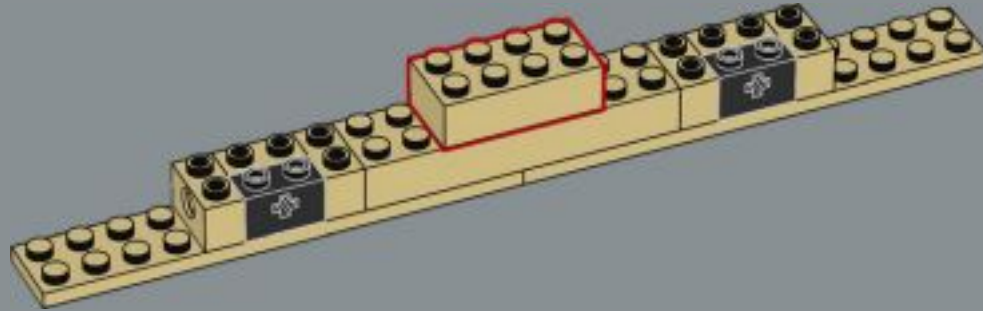

35

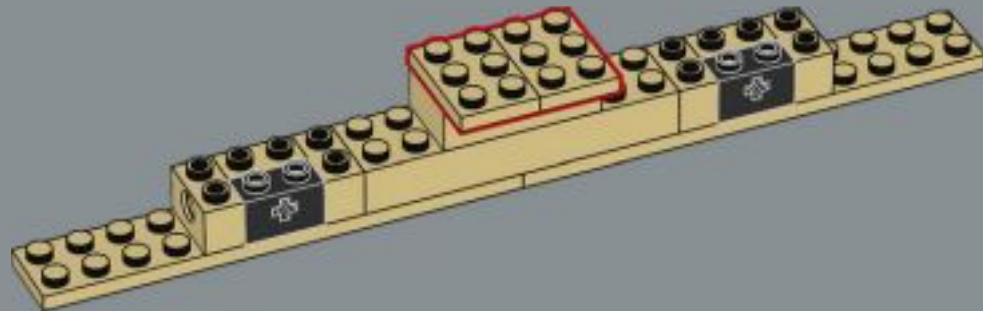

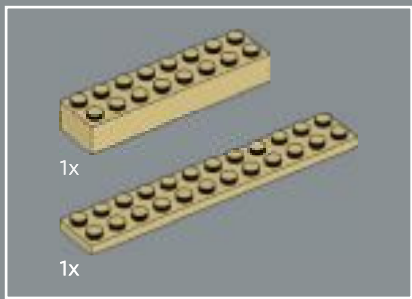

36

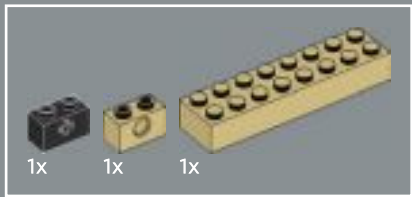
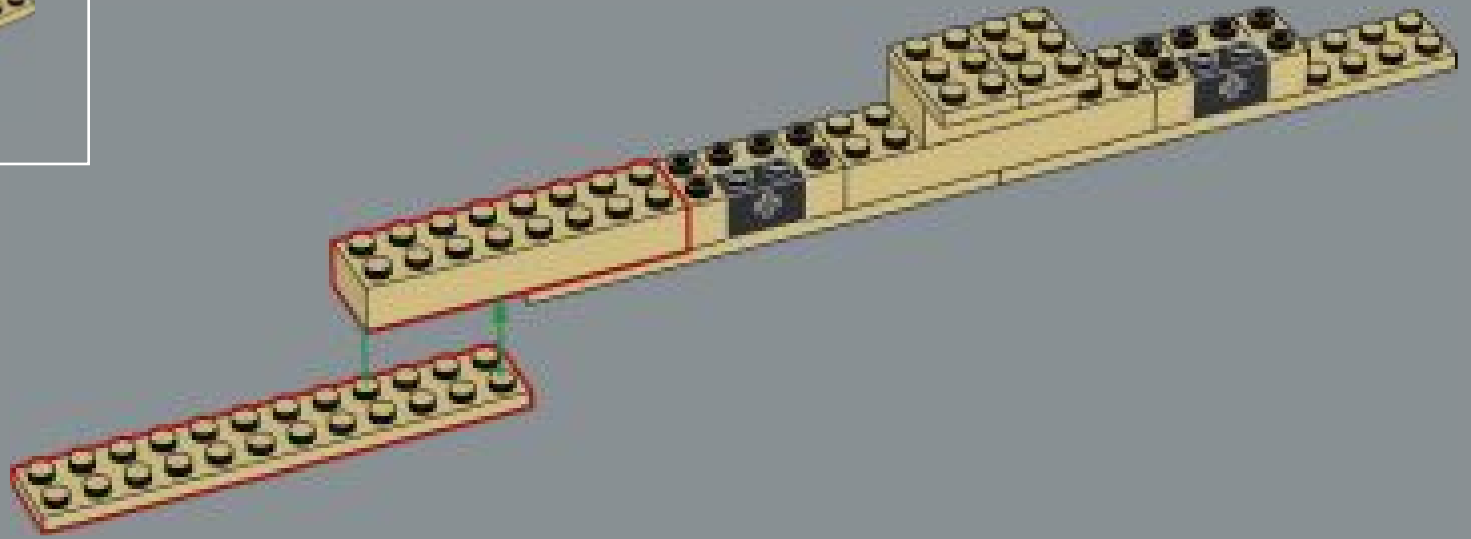

37

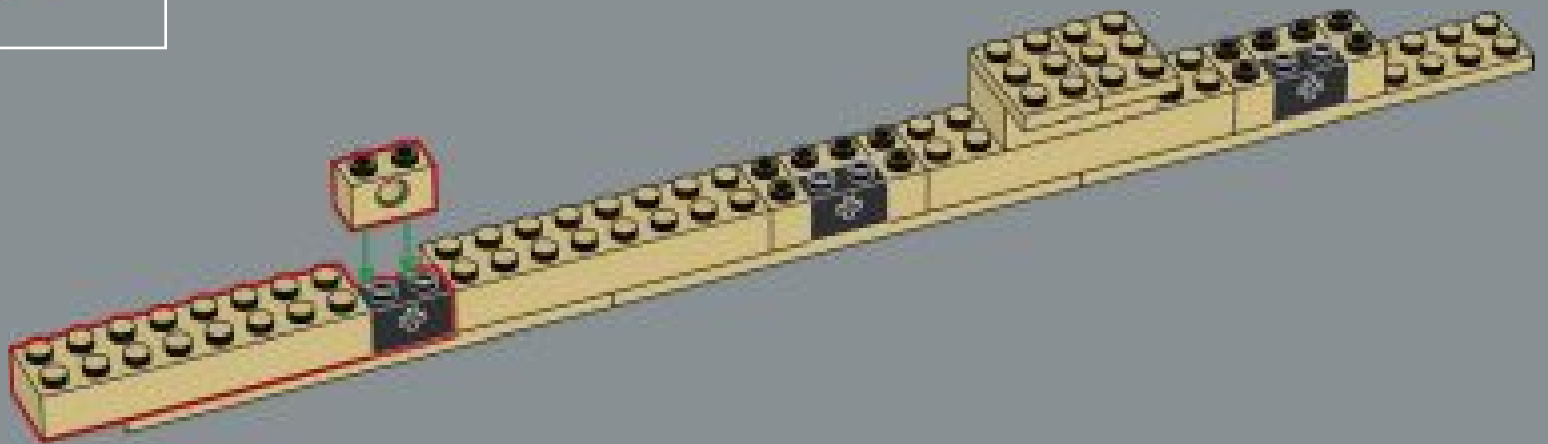

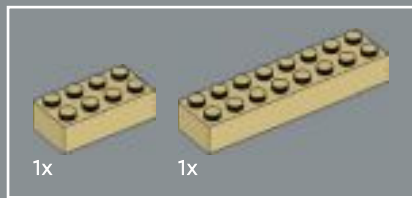

38

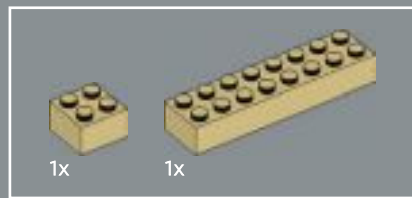
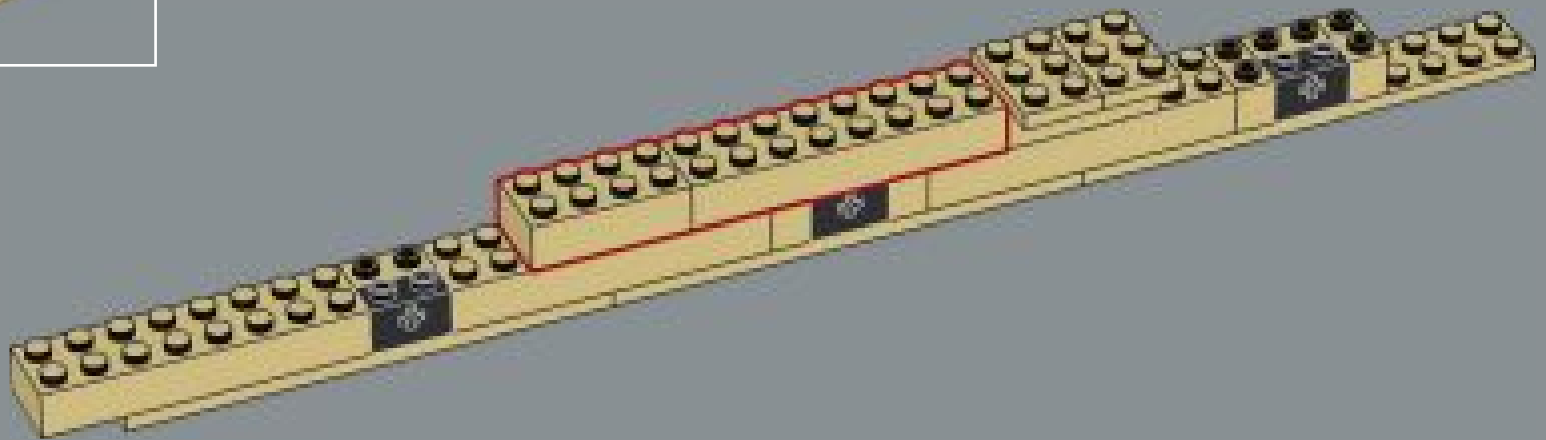

39

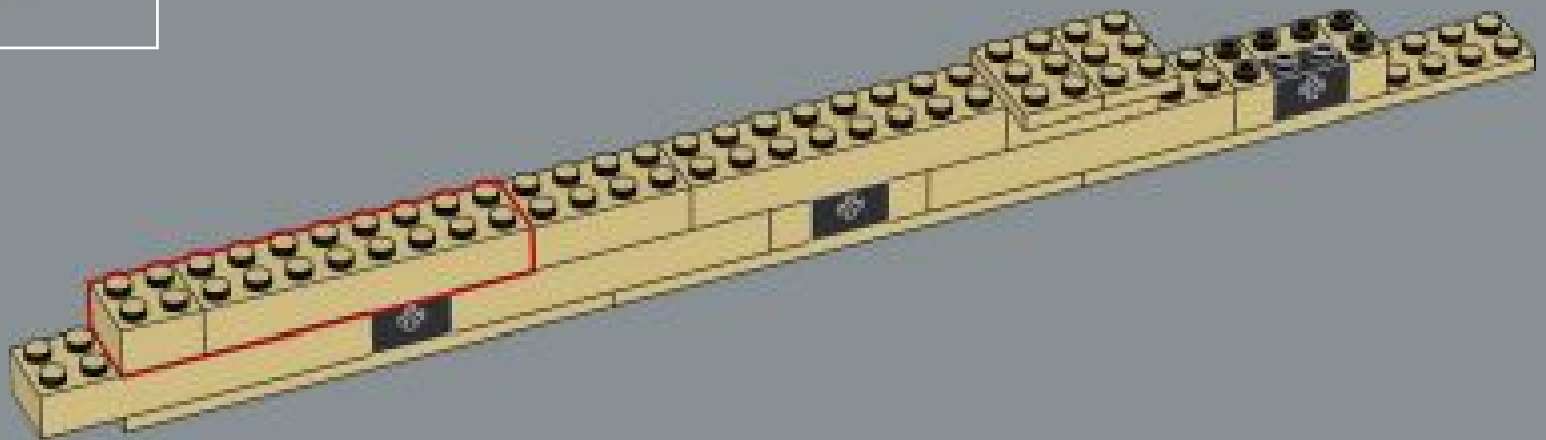

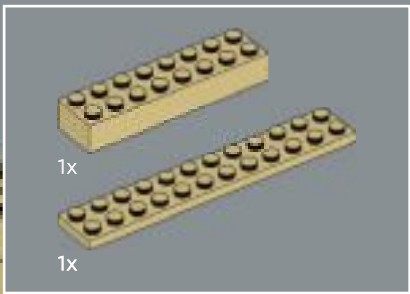

40

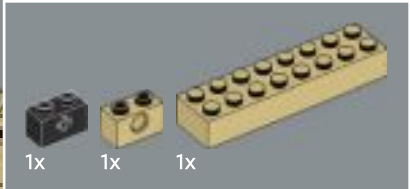
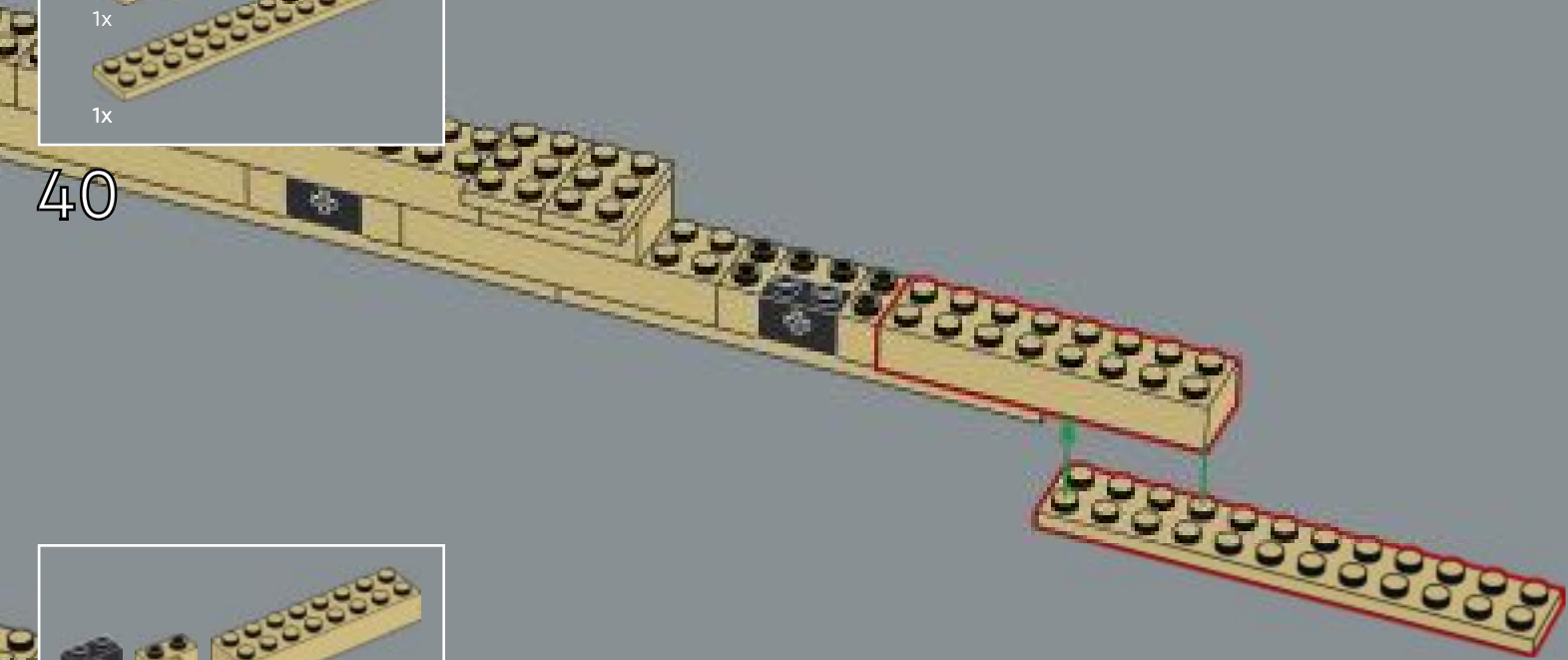

41

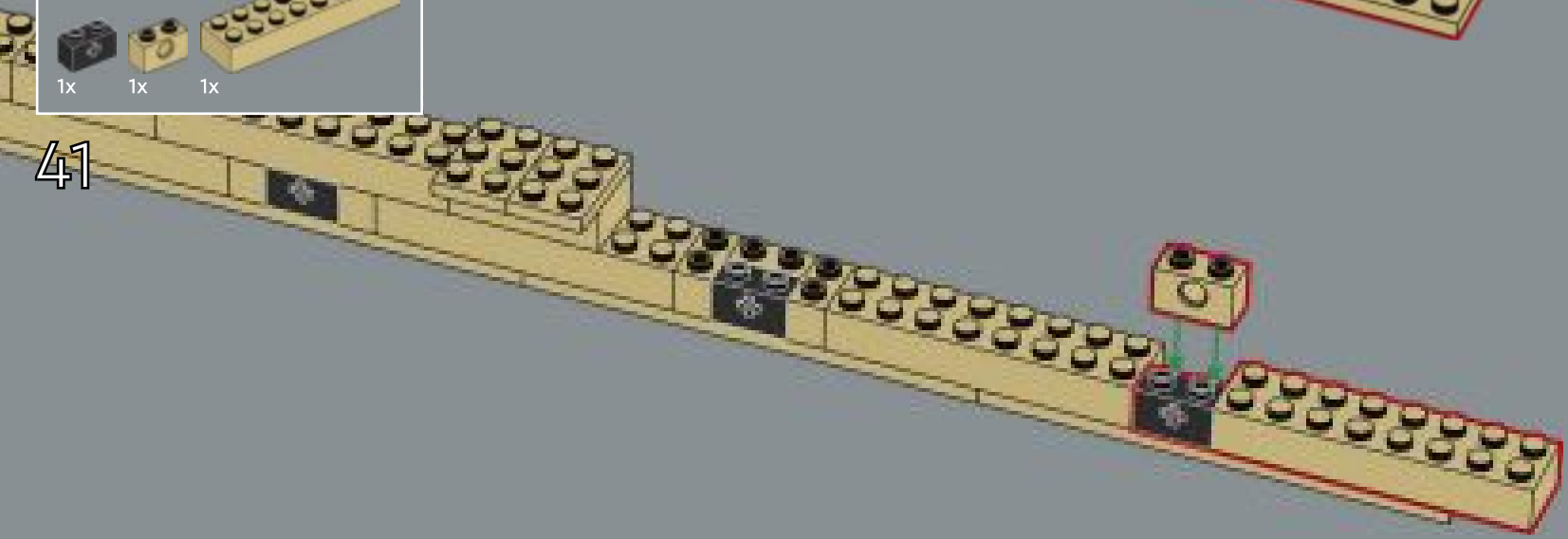

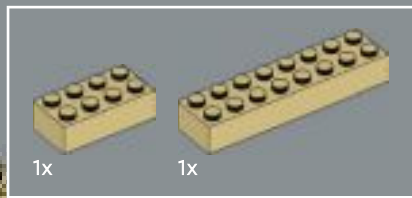

42

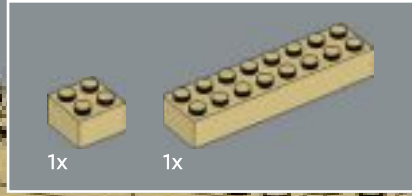
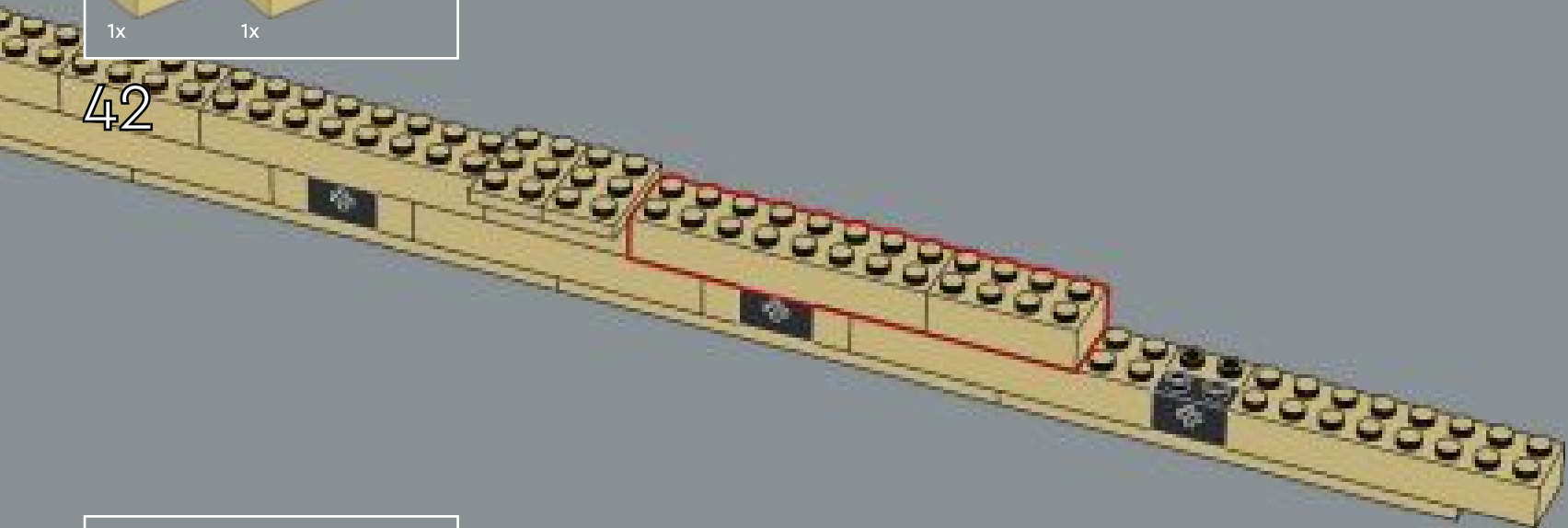

43

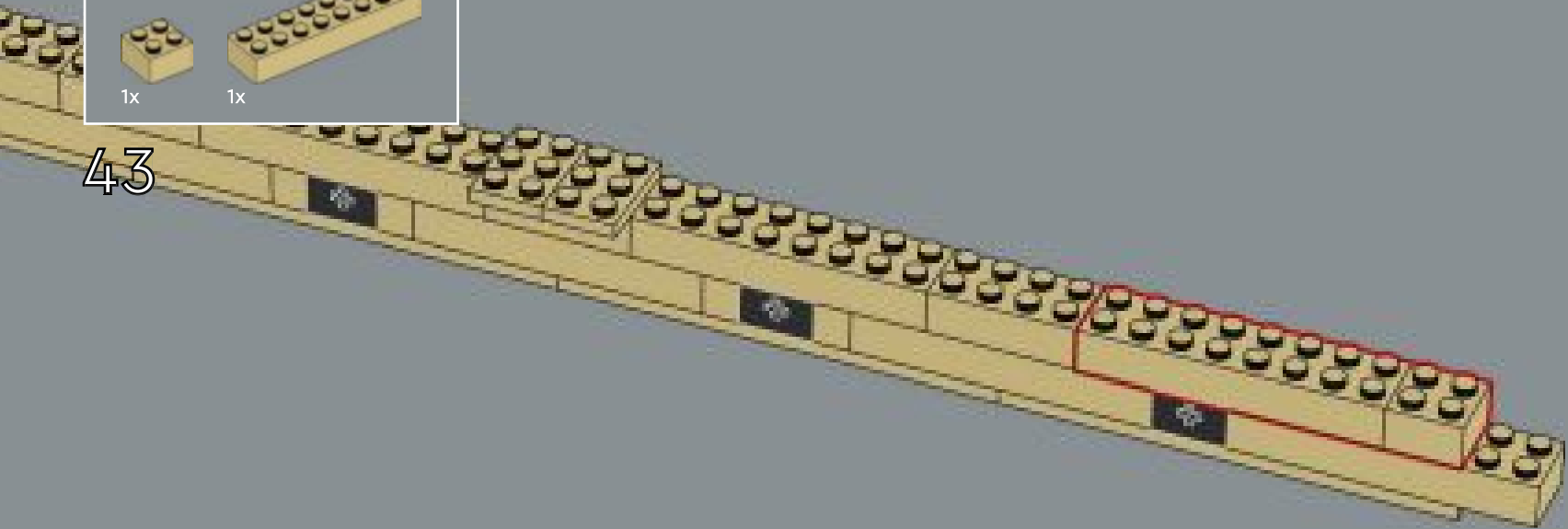

44

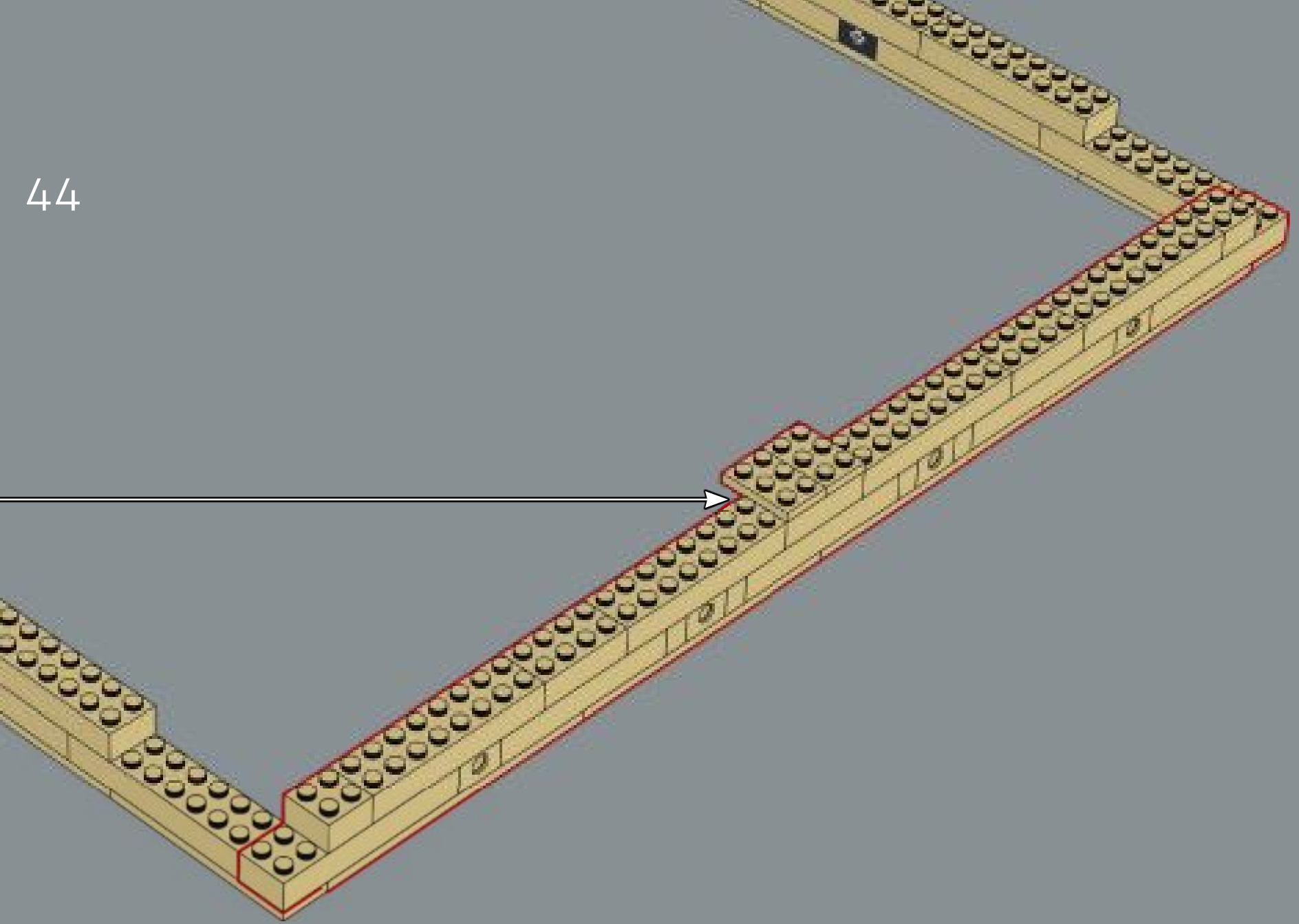

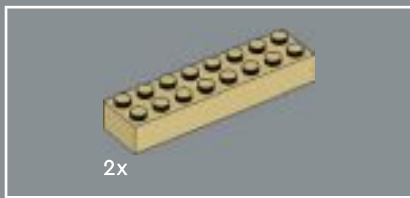

45

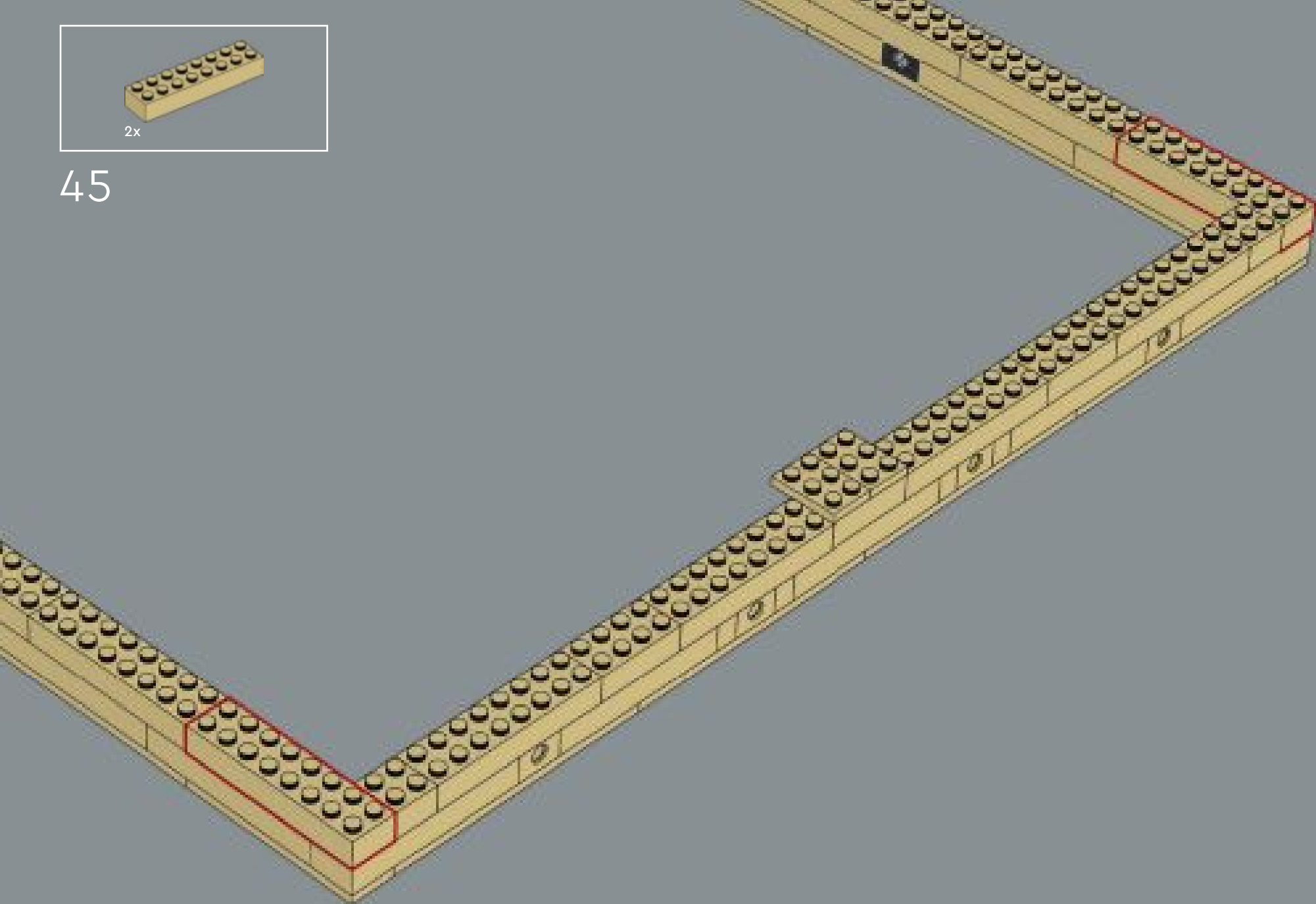



46

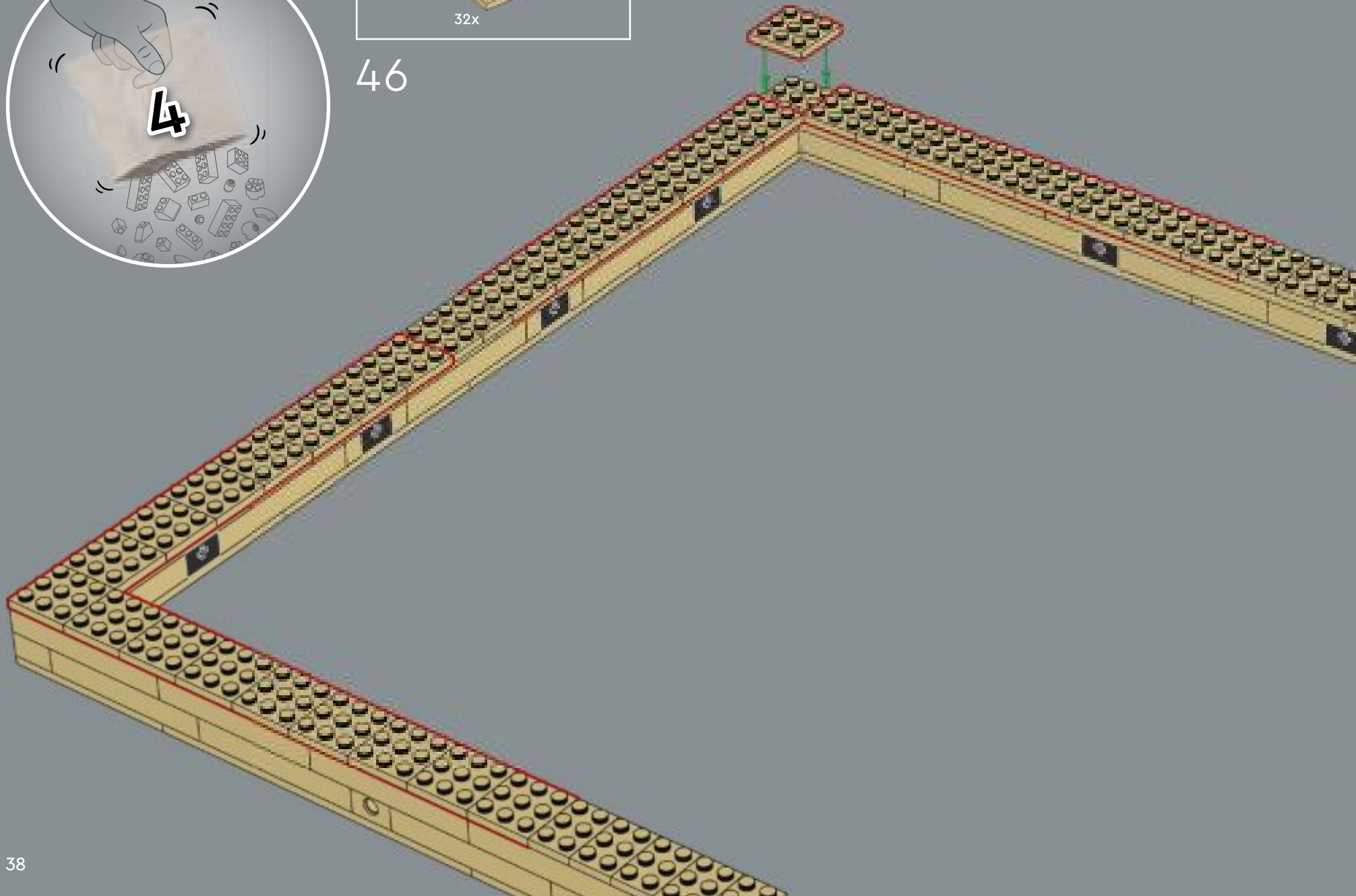



47

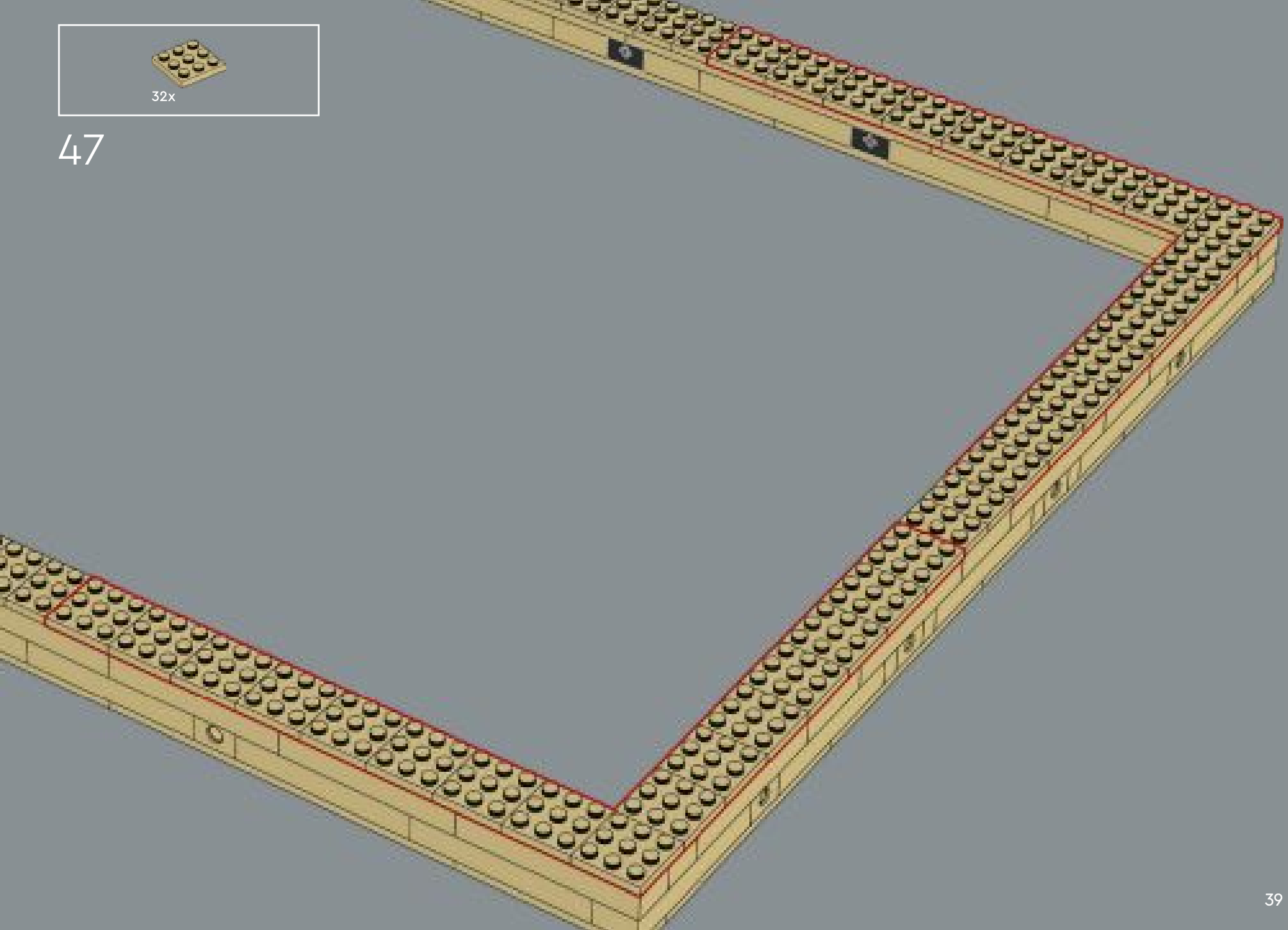

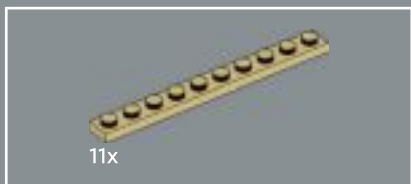

48

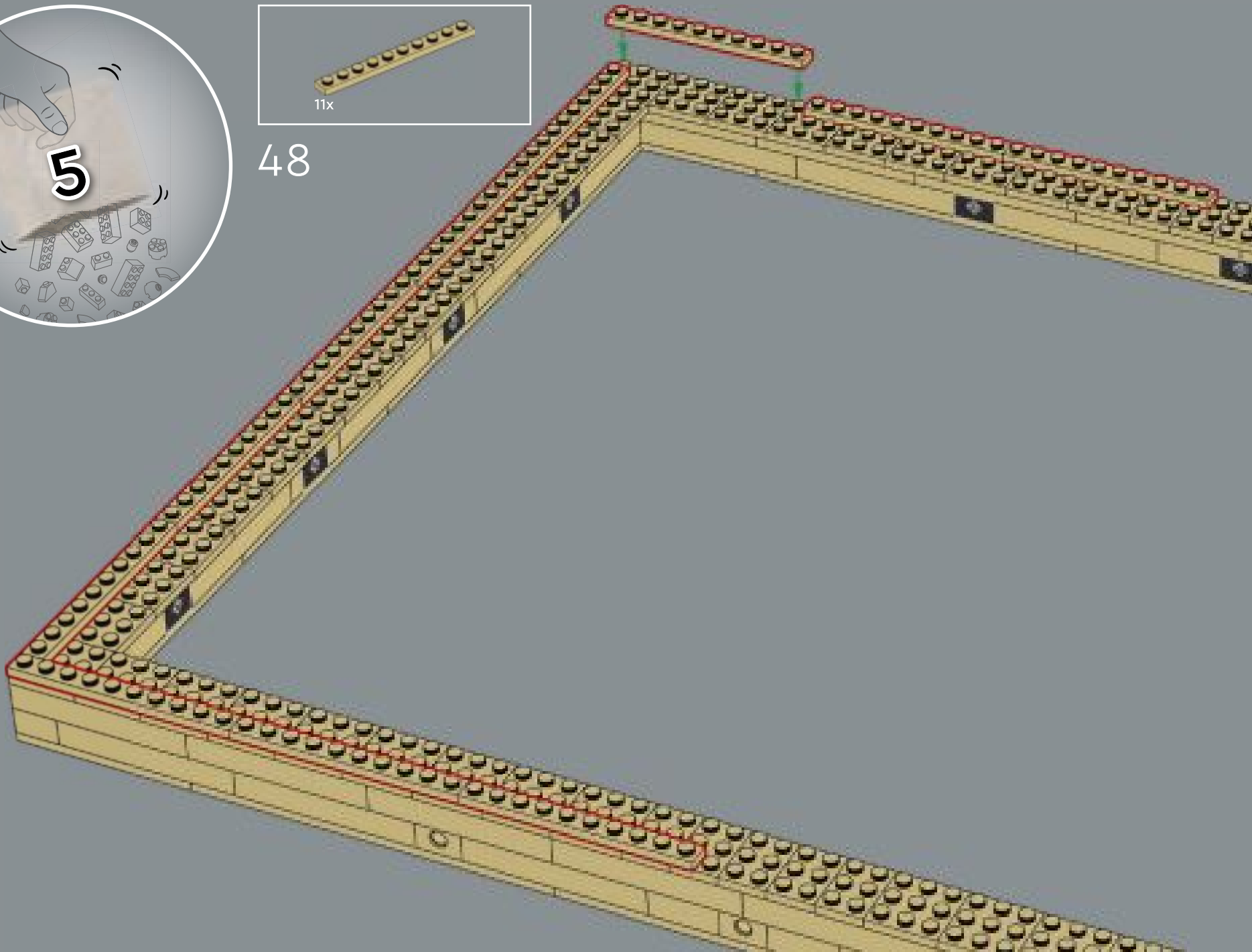

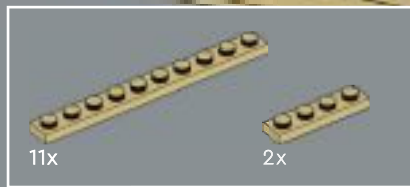

49





50





51

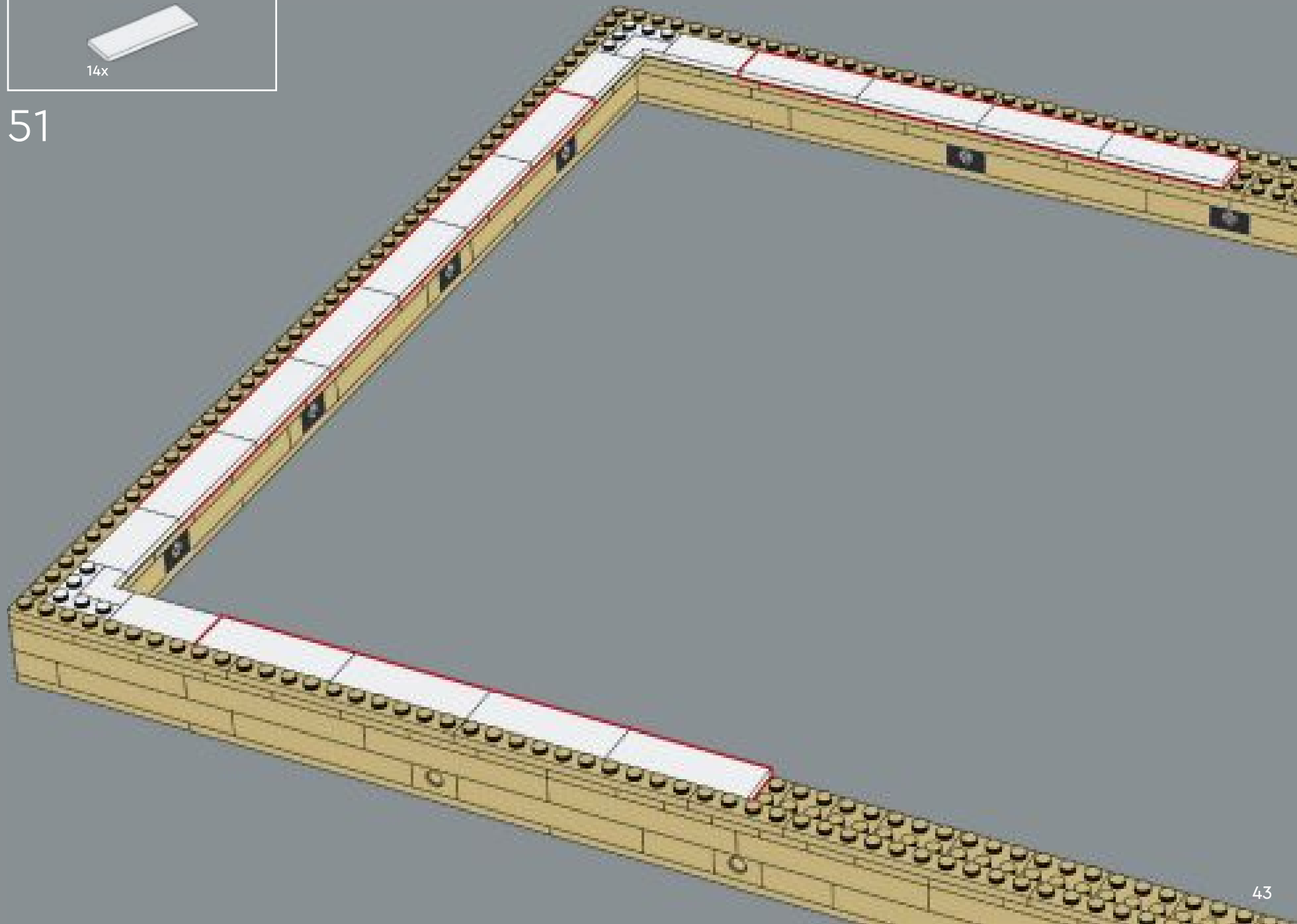



52





53





54

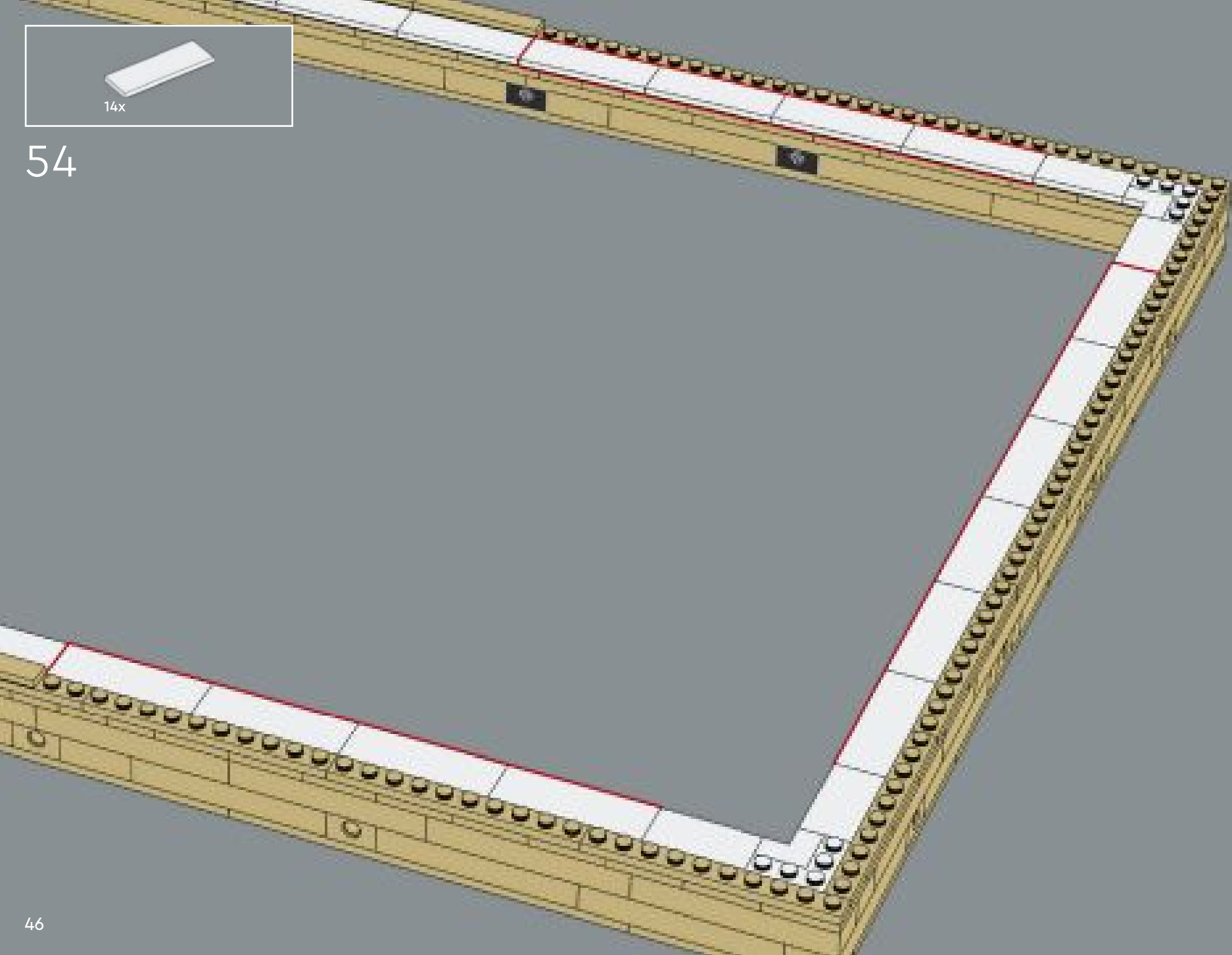



55

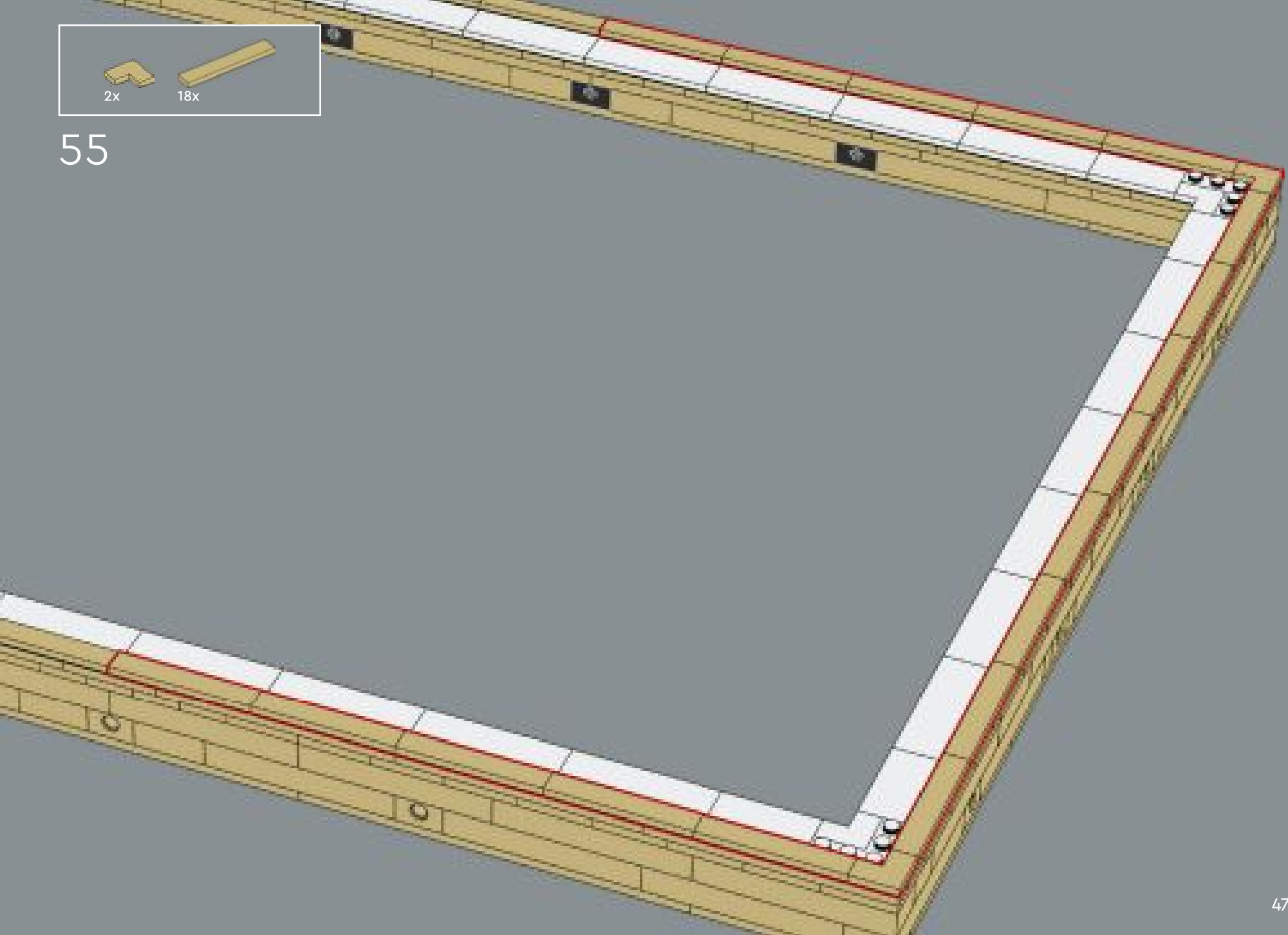

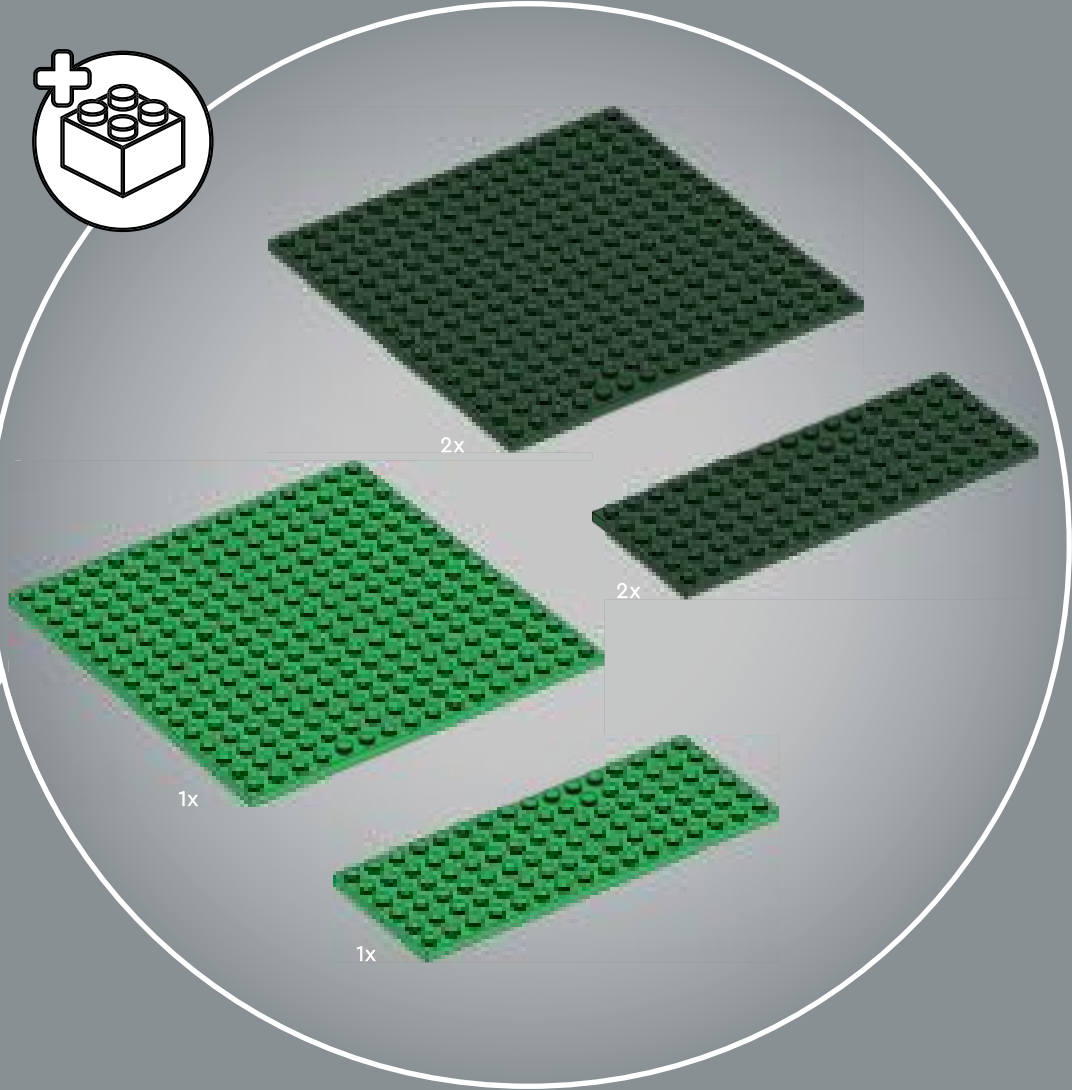
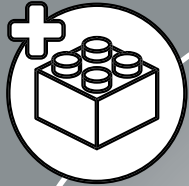

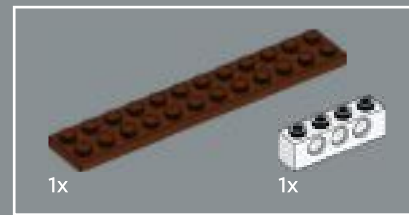
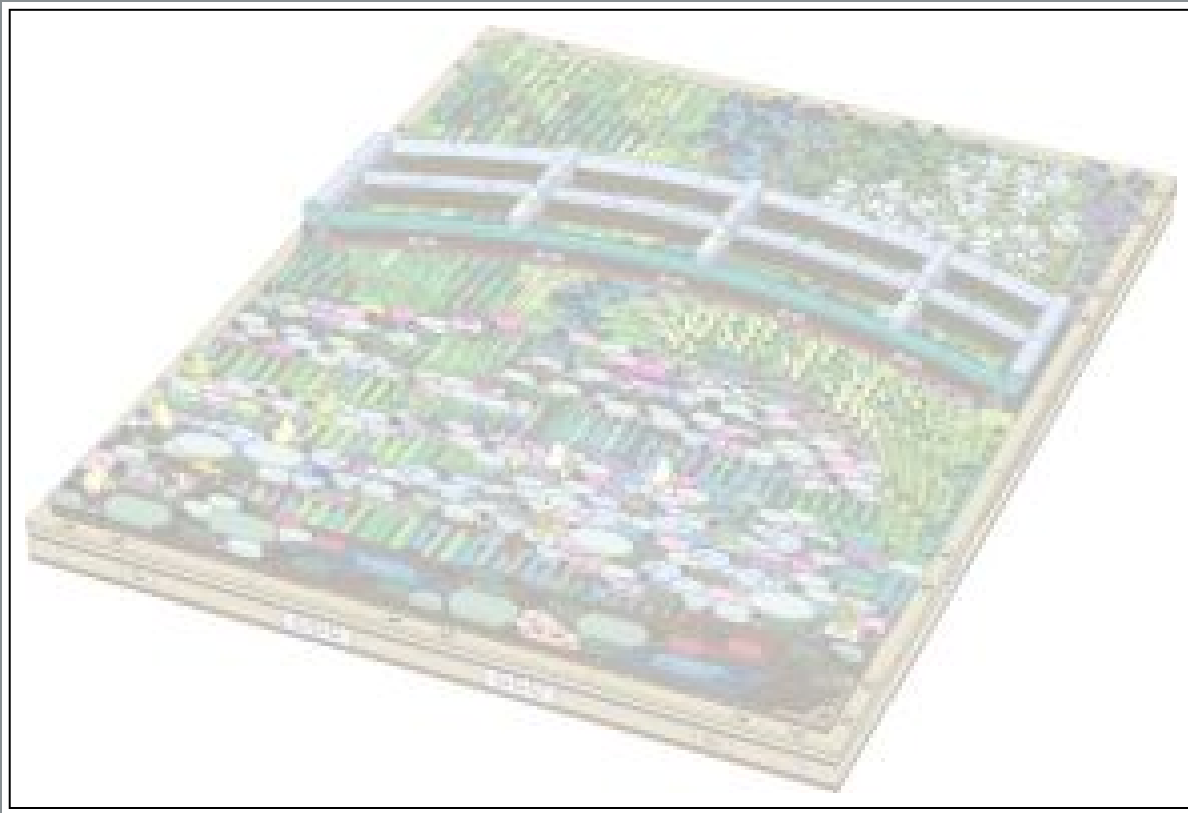

56

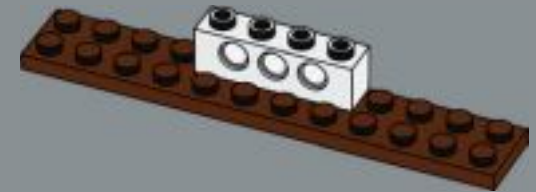

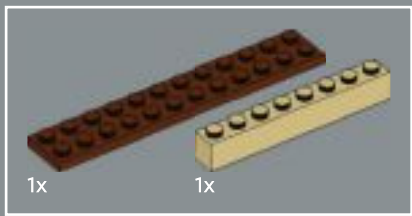

57

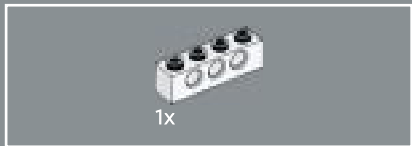
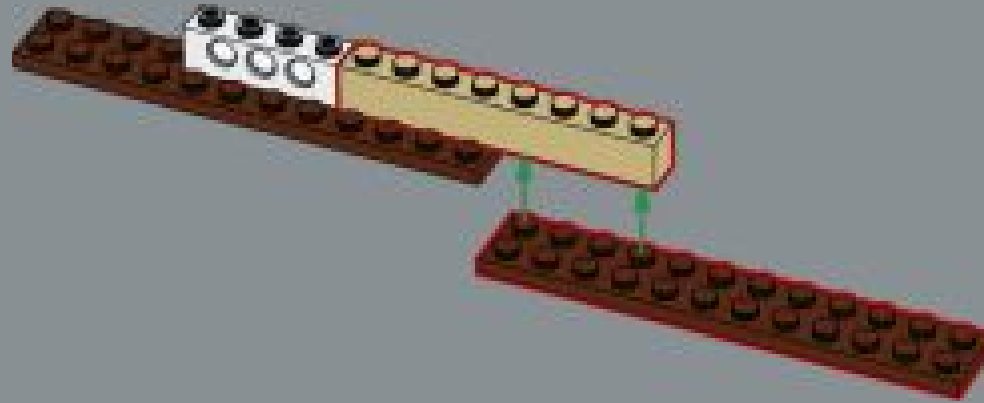

58

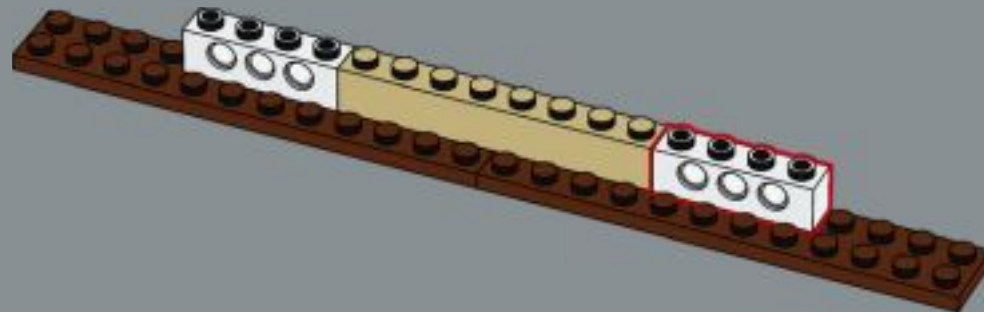



59

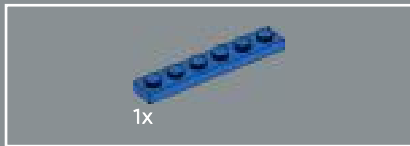
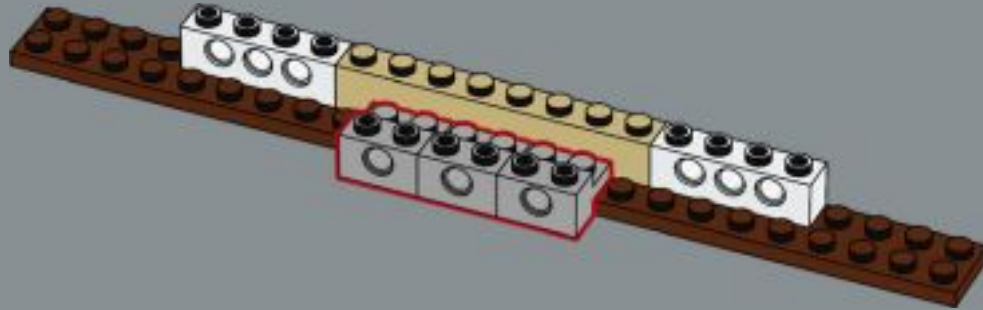

60

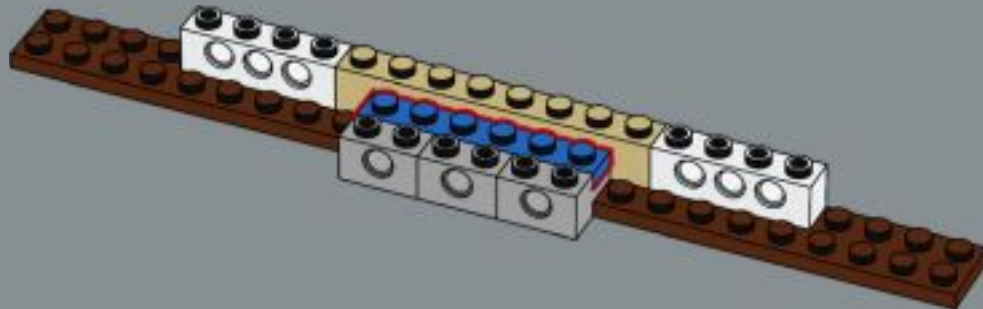



61

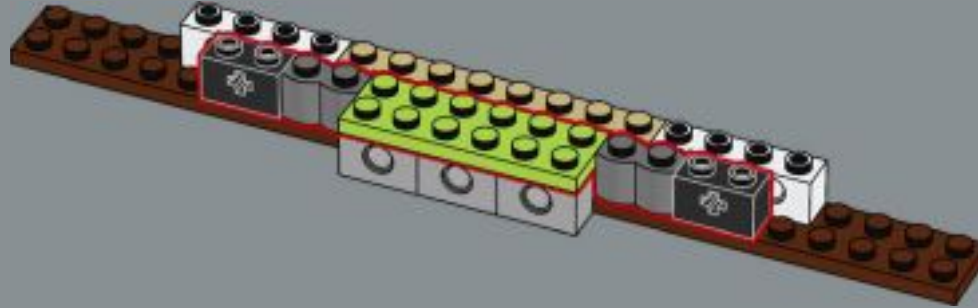

62

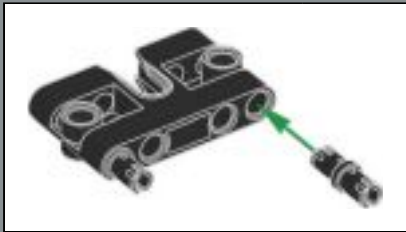
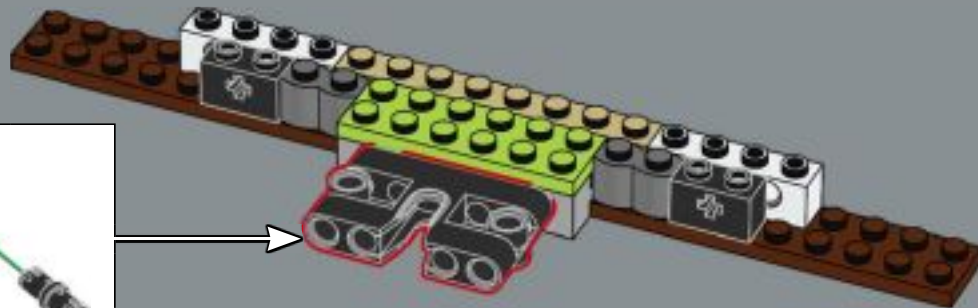

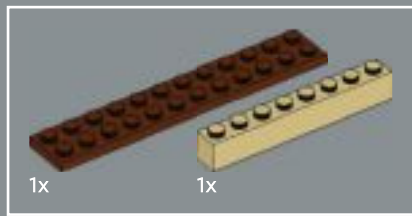

63

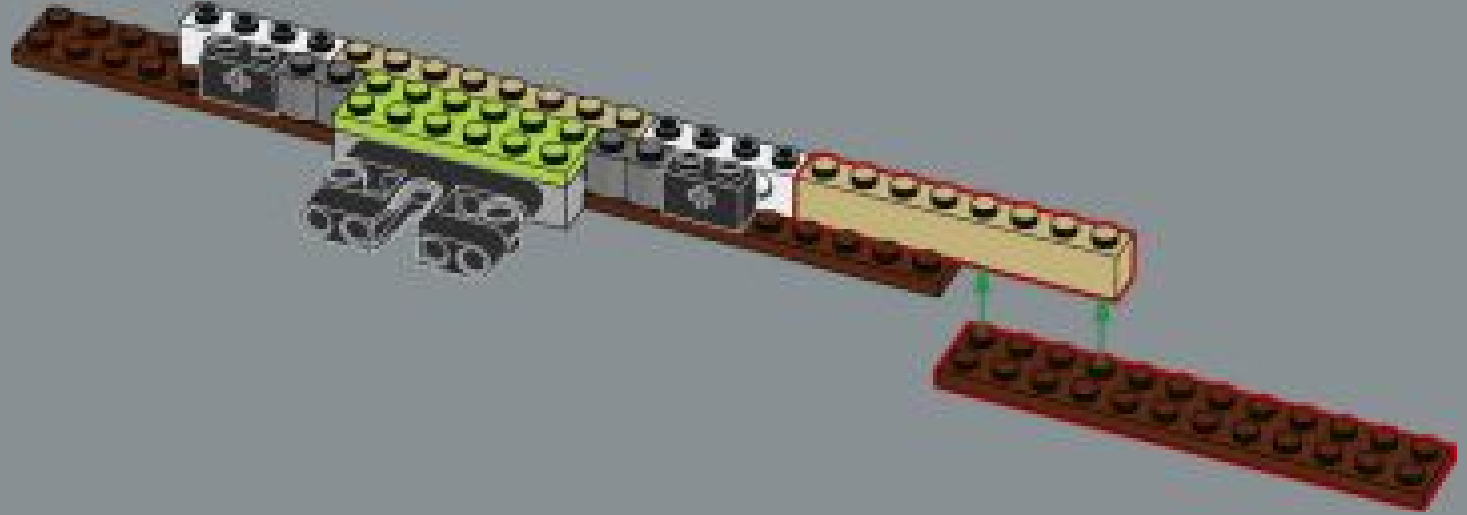

64

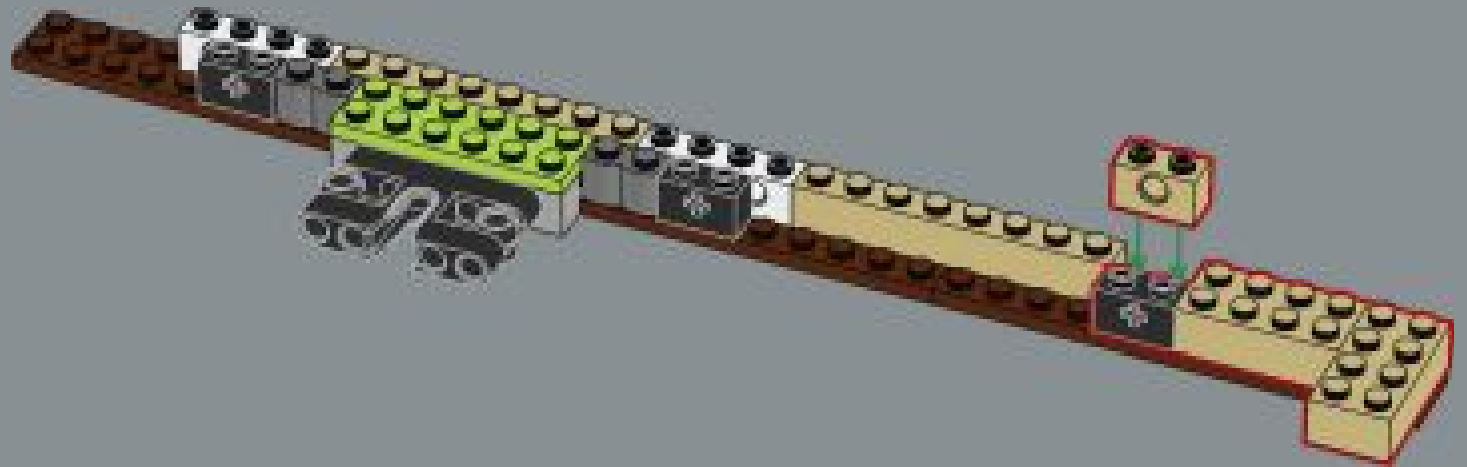

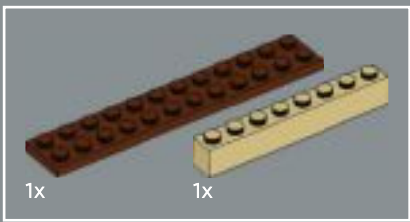

65

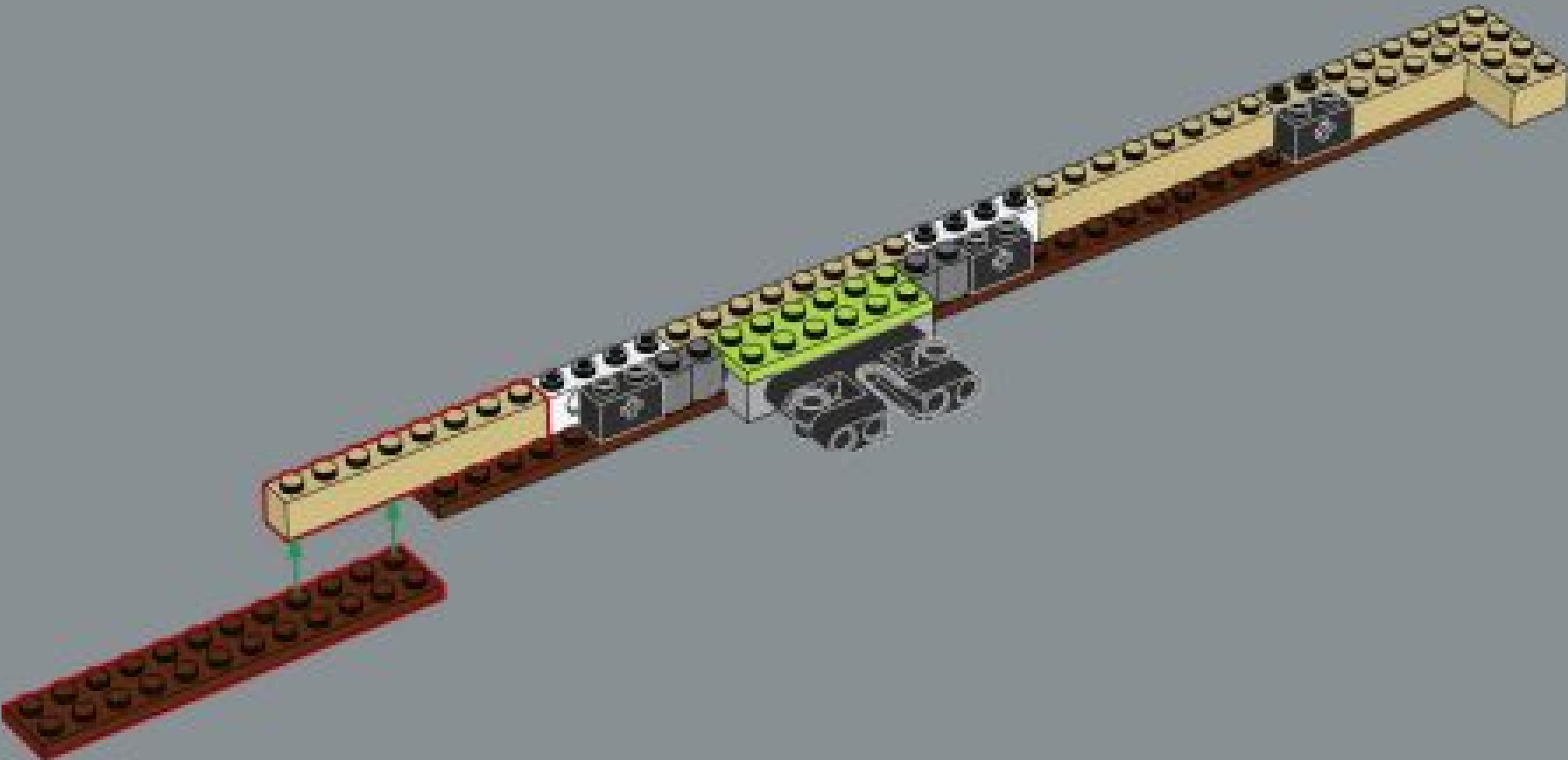



66

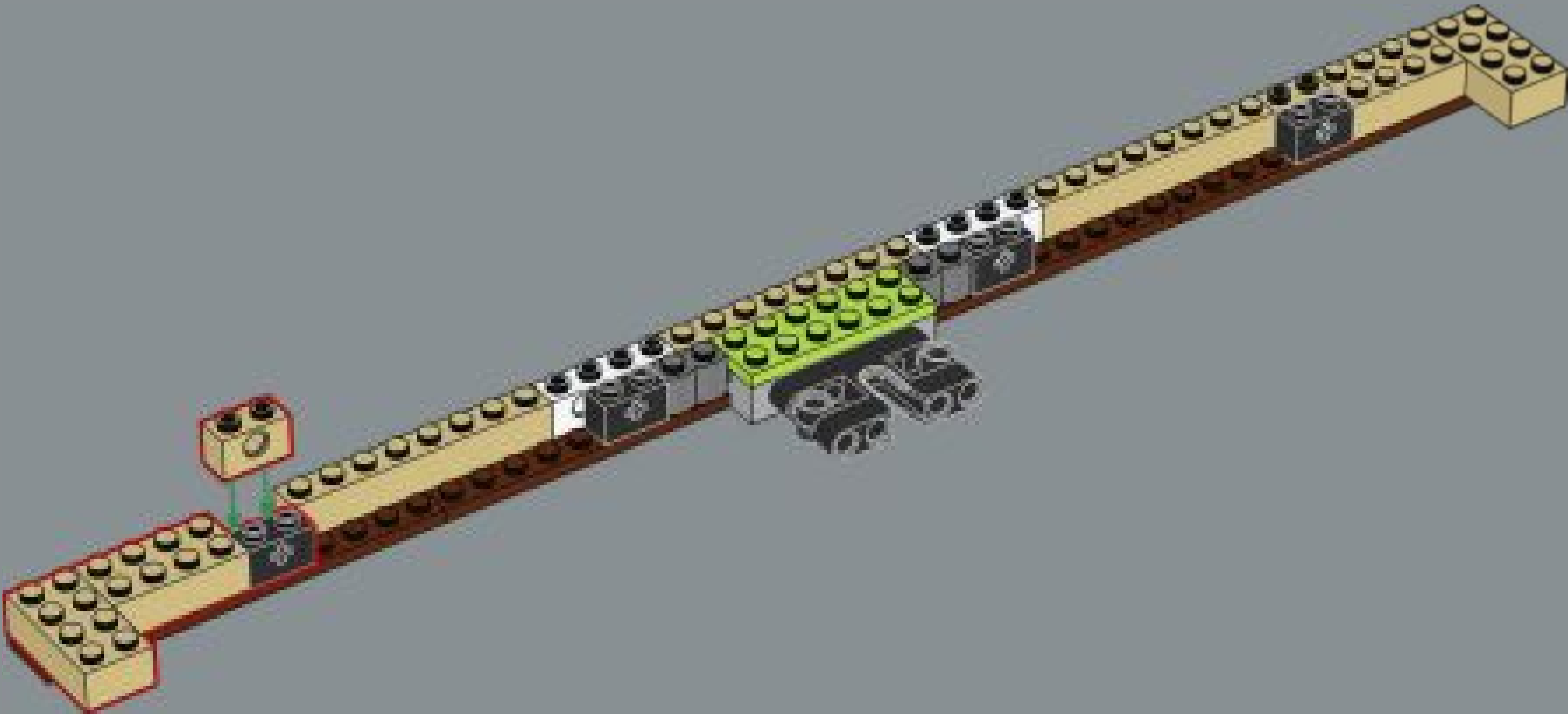



67

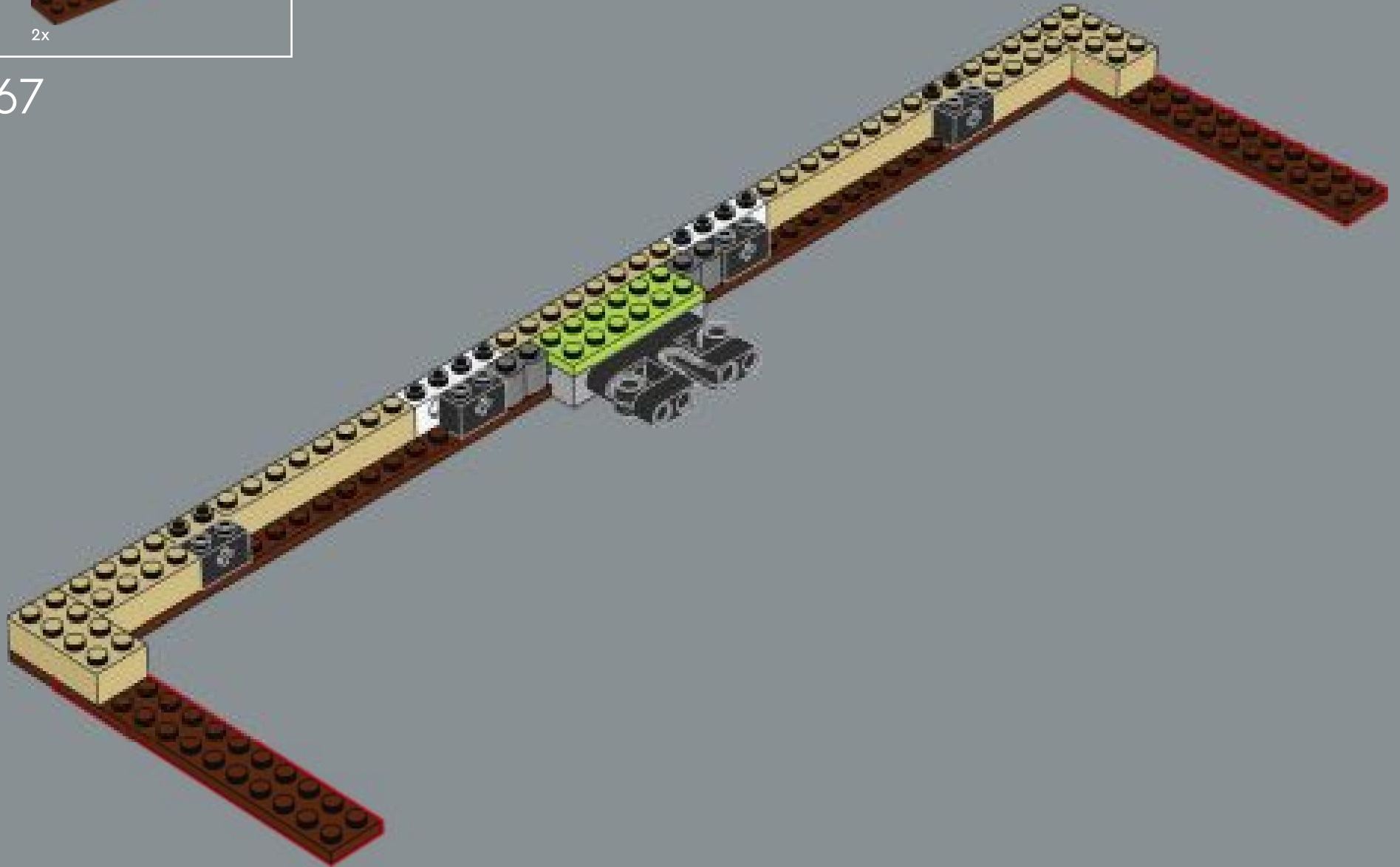

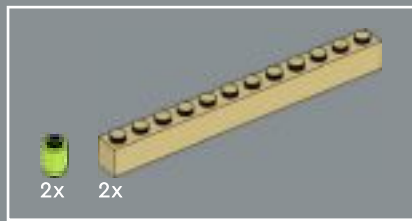

68

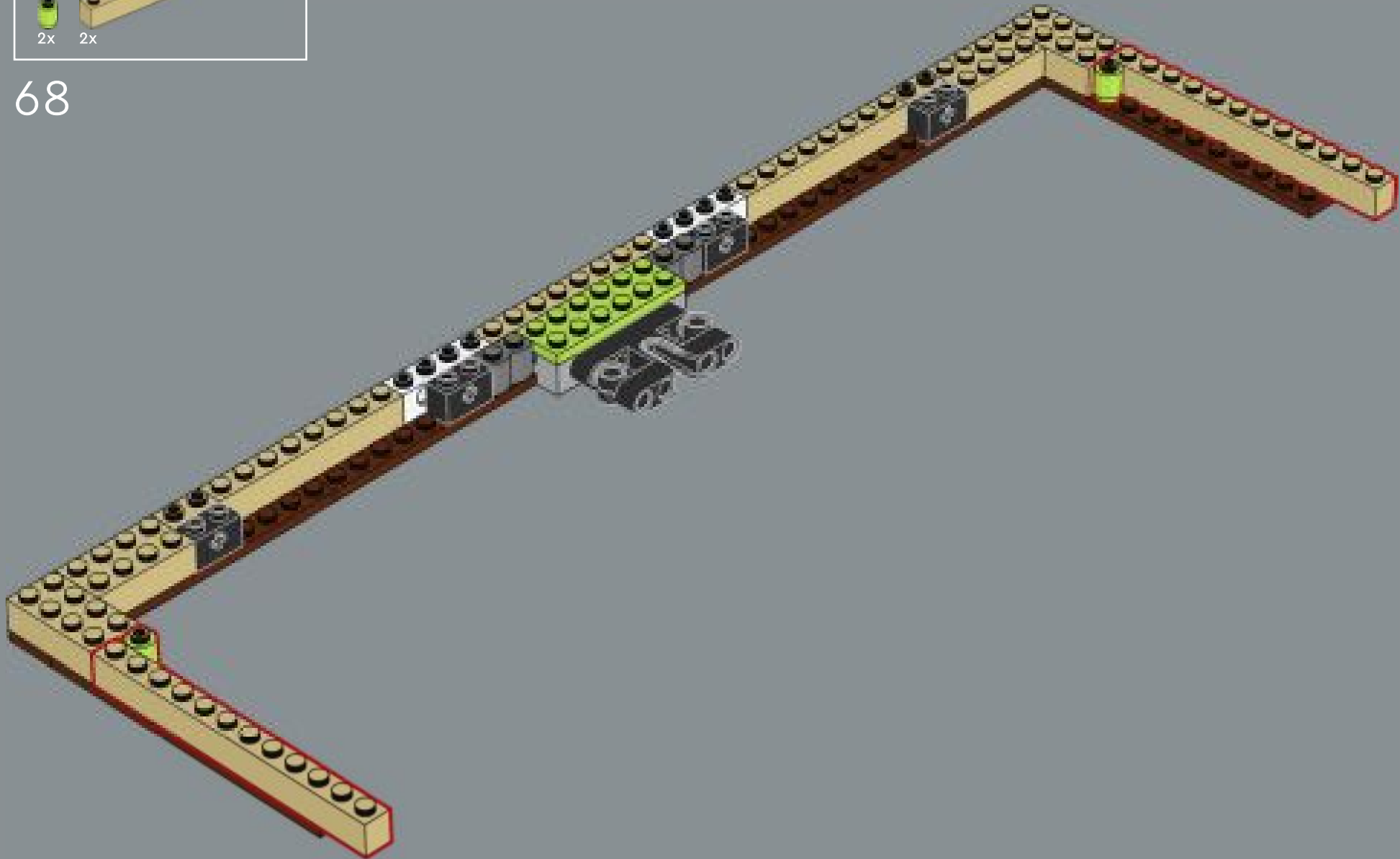

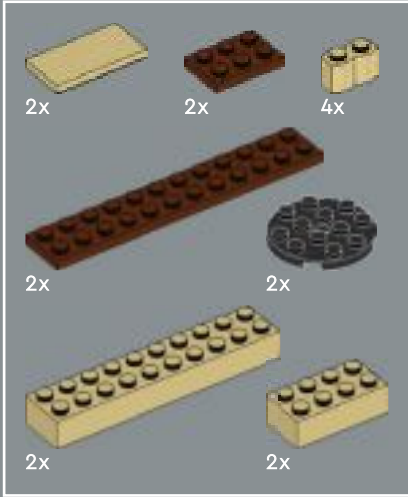

69

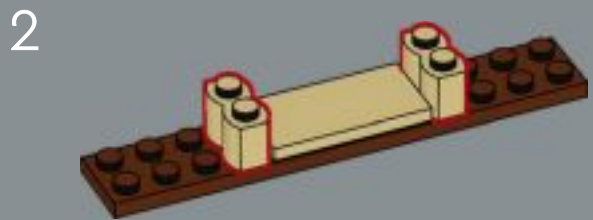

3

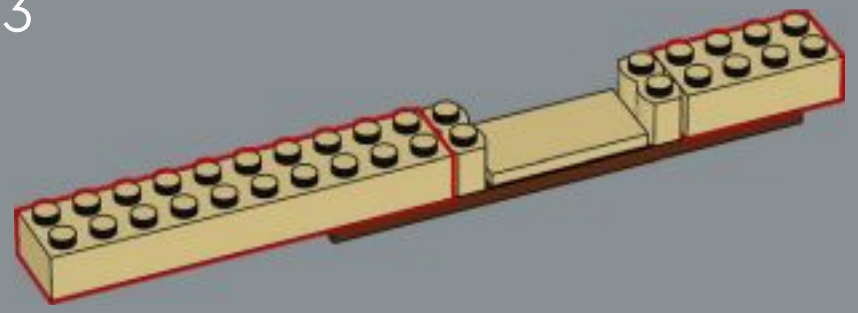

4

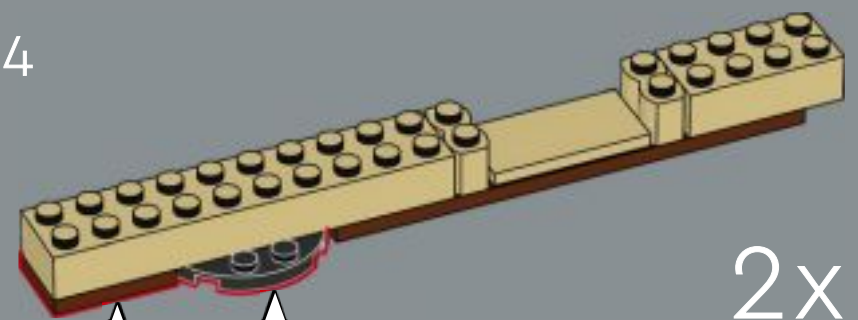

2x



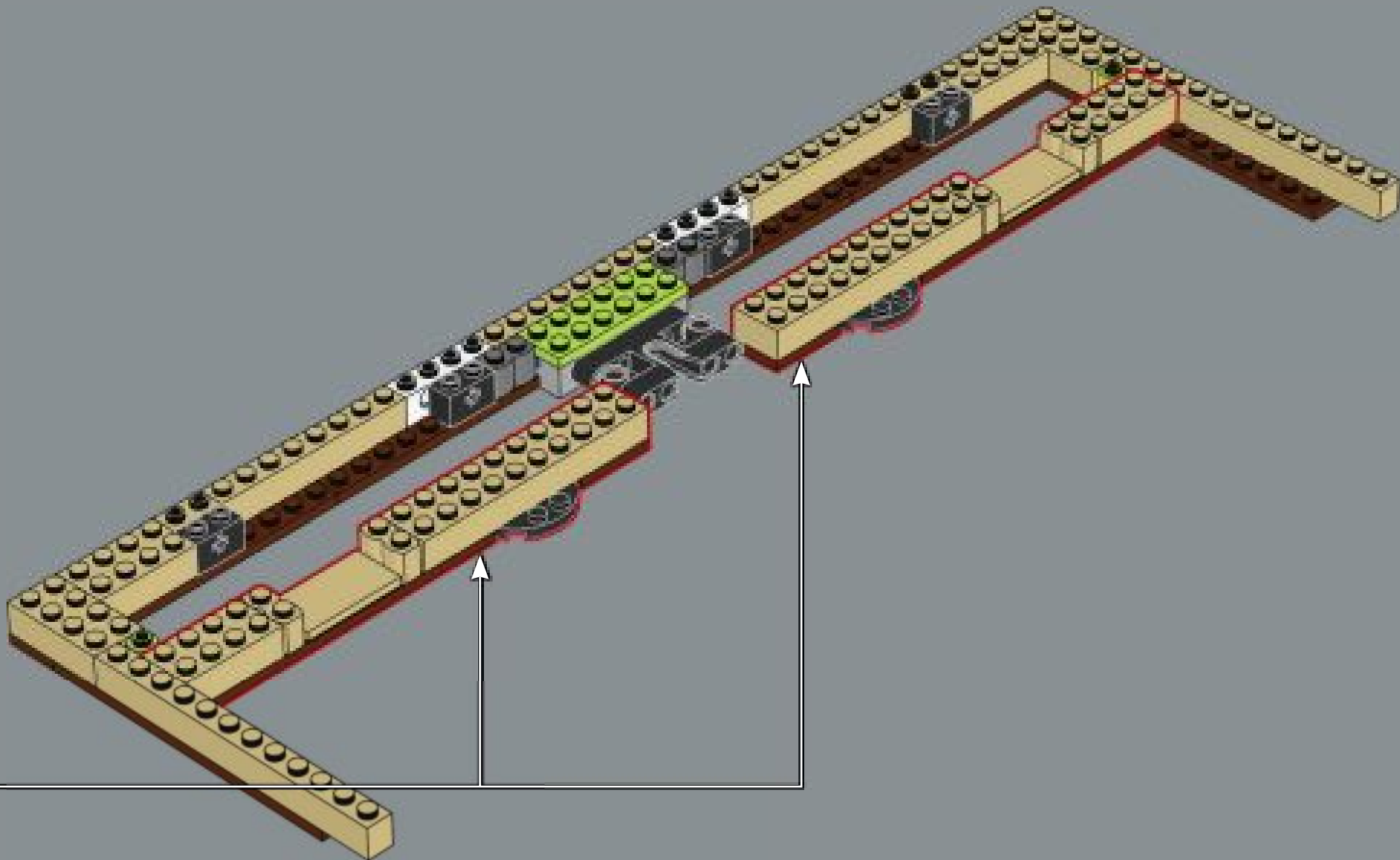



70

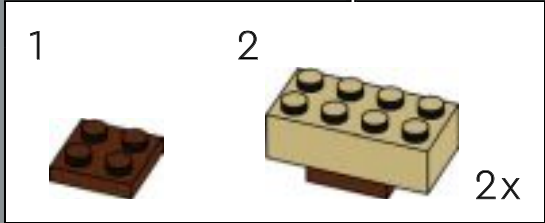
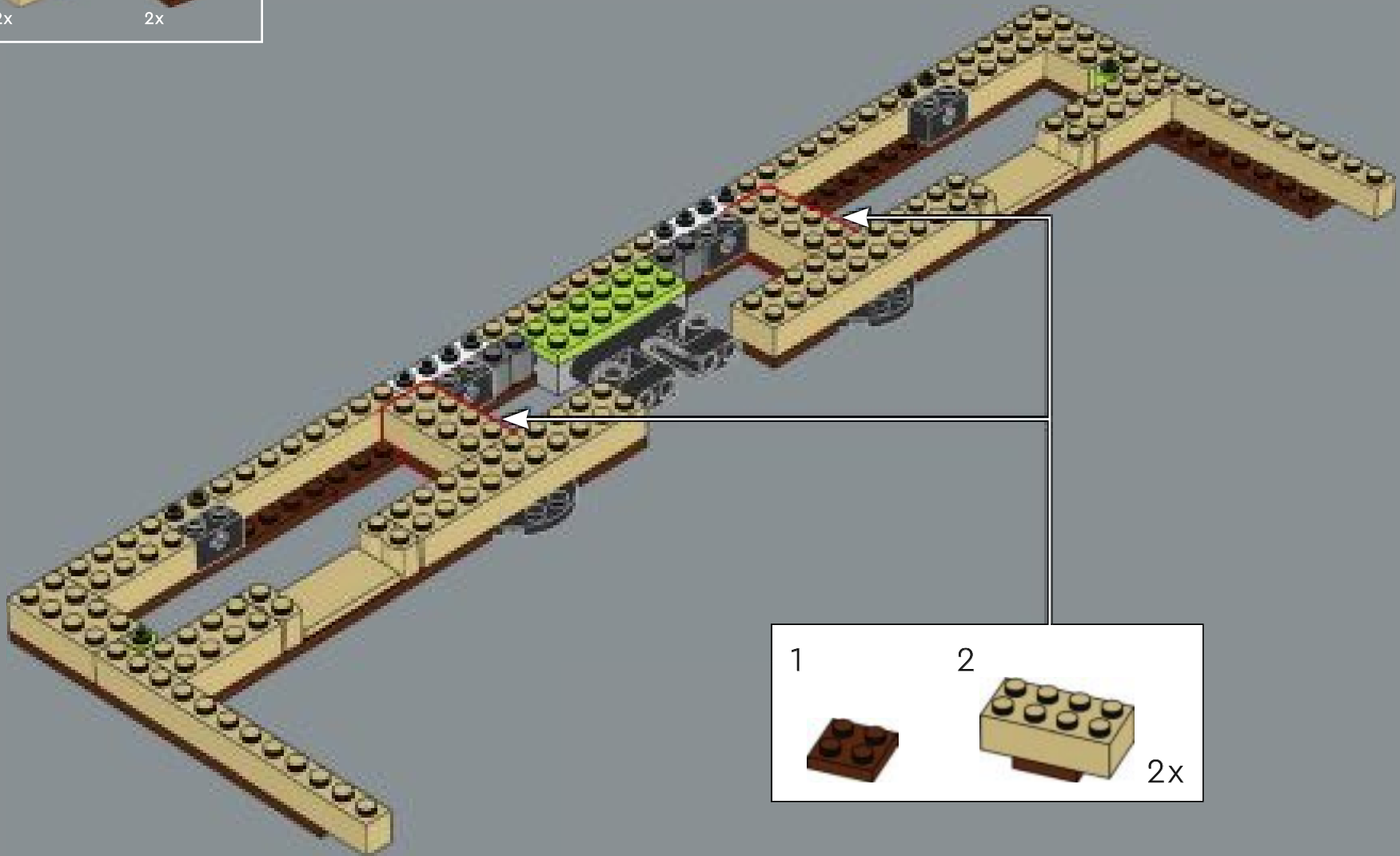



71





2x

72





73

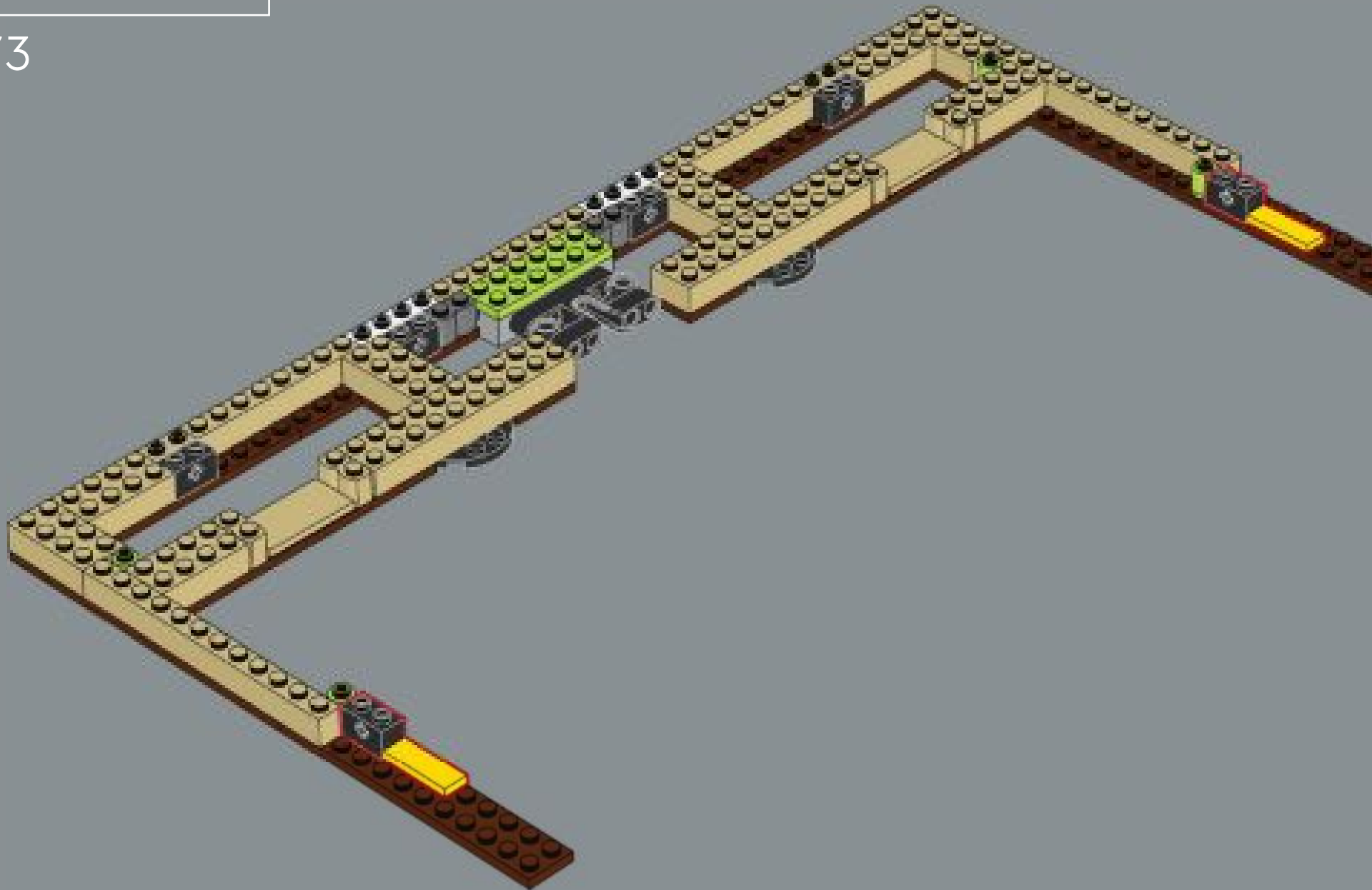



74



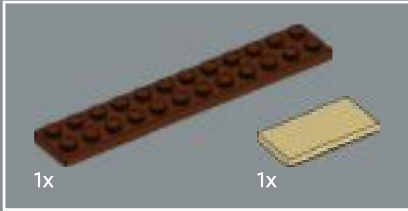
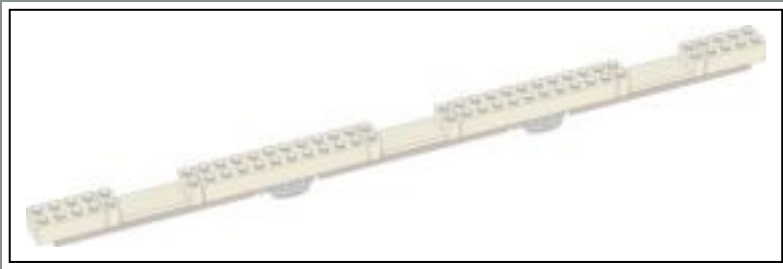

75



76

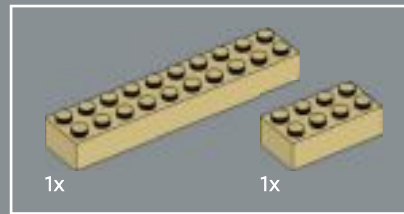
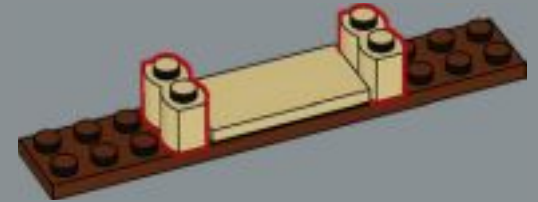

77

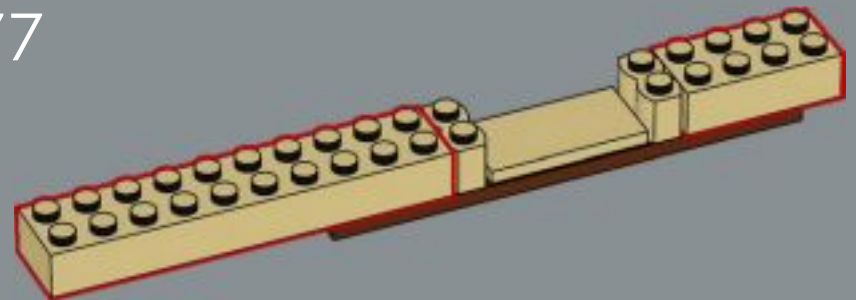

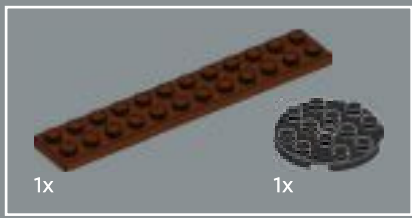

78

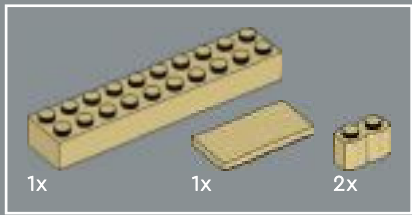
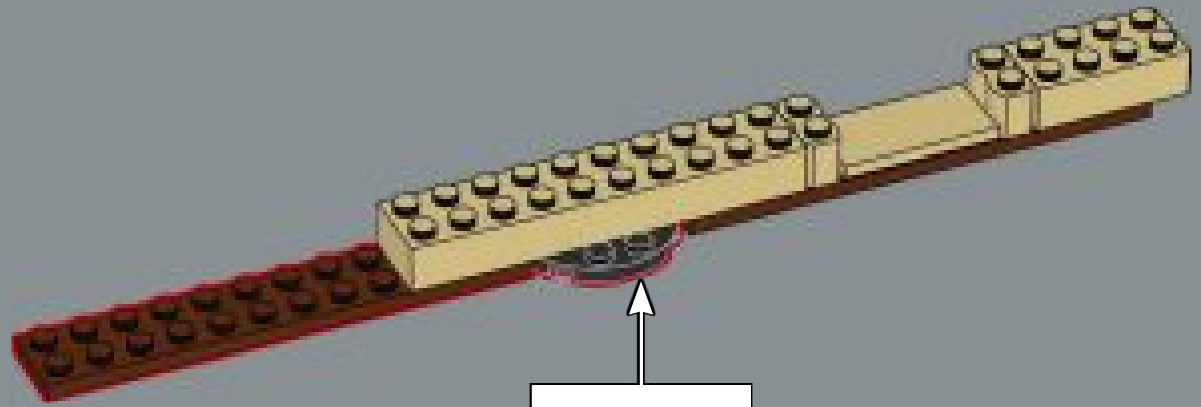

79

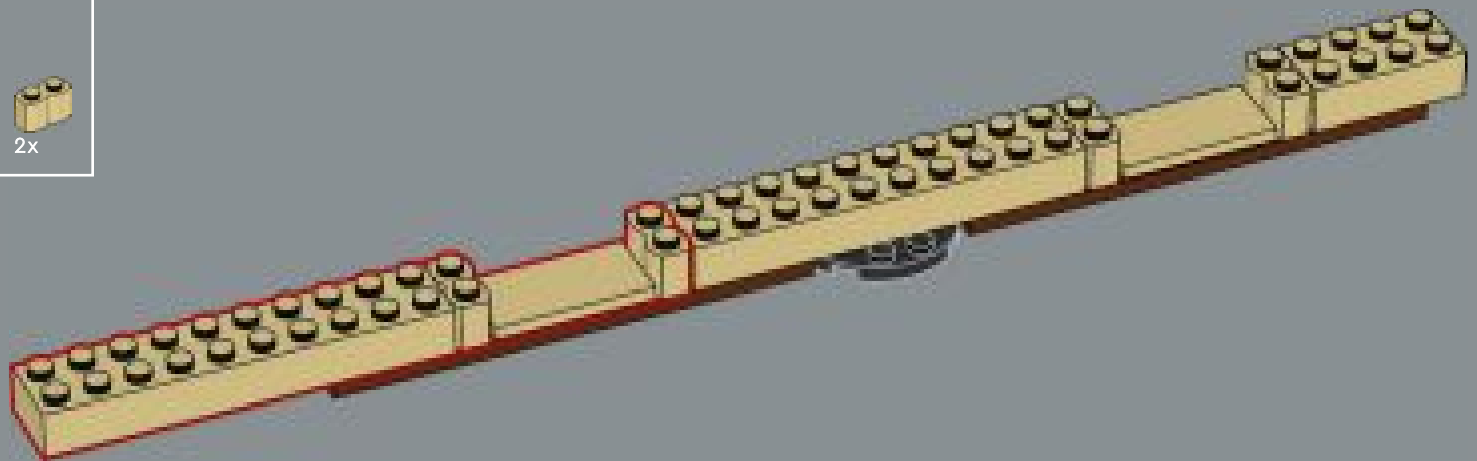

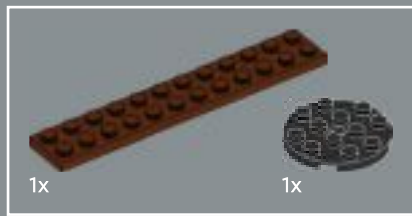

80

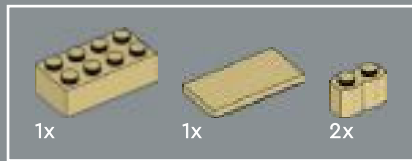
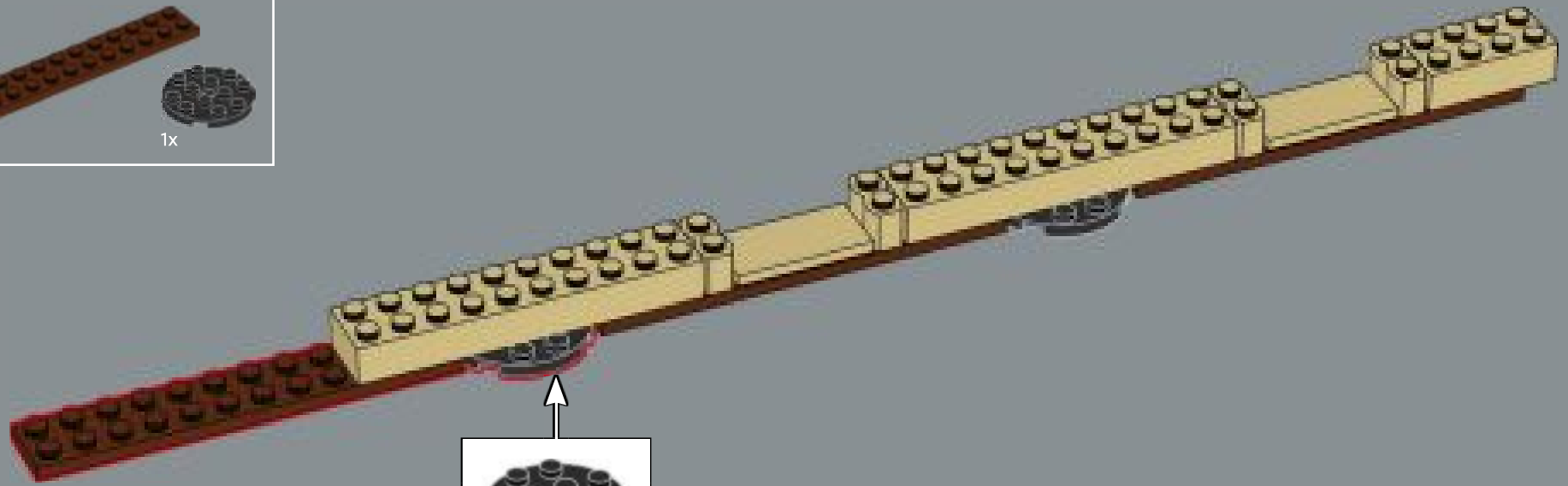

81

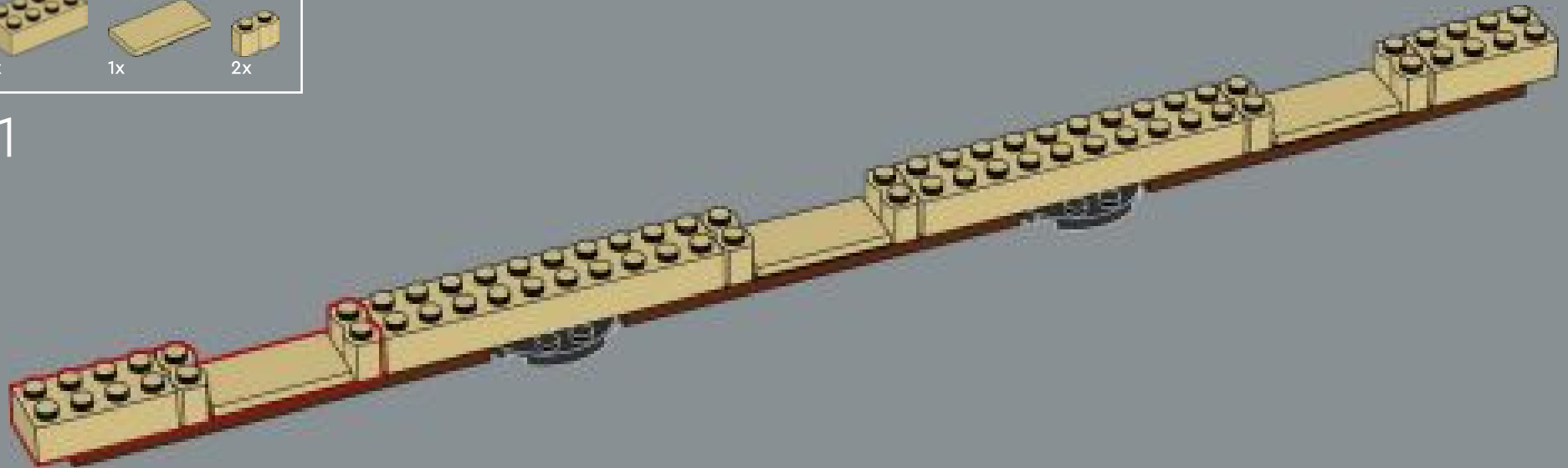

82

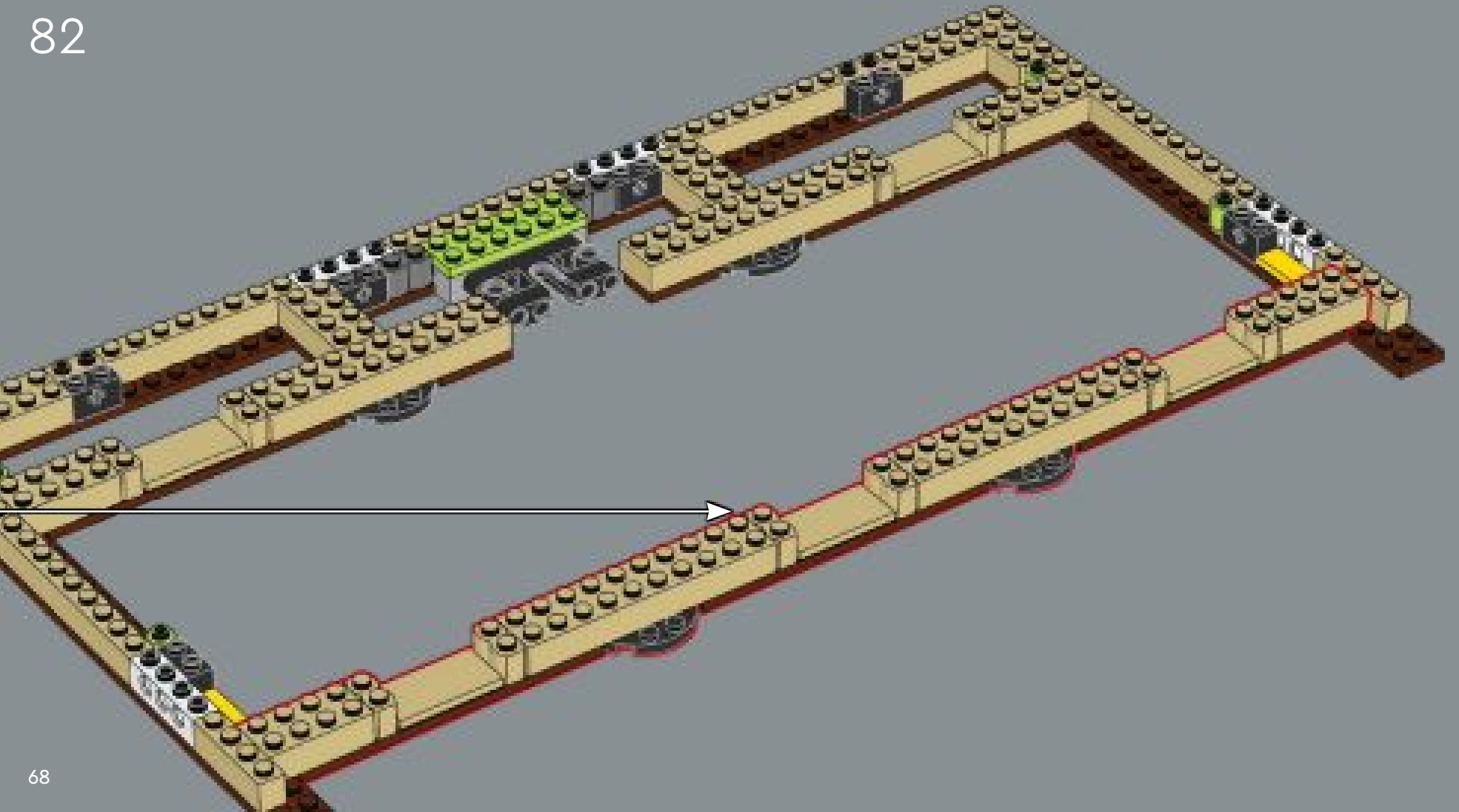

68

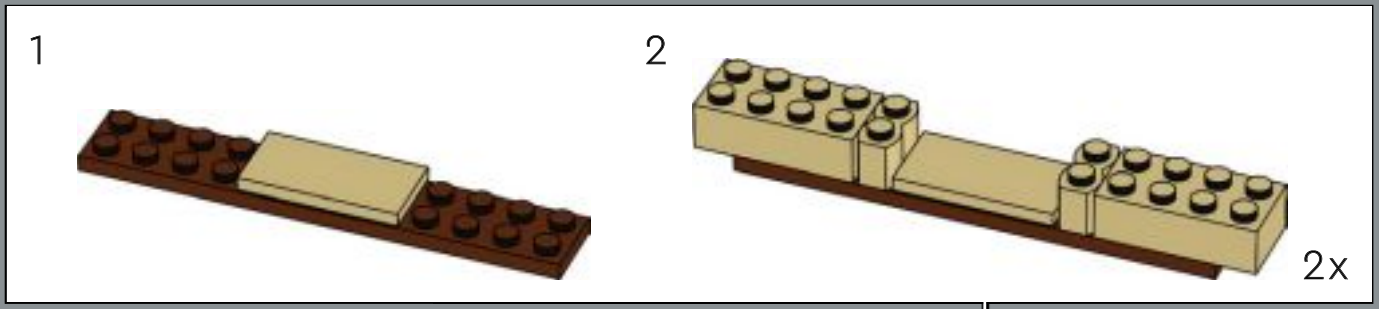
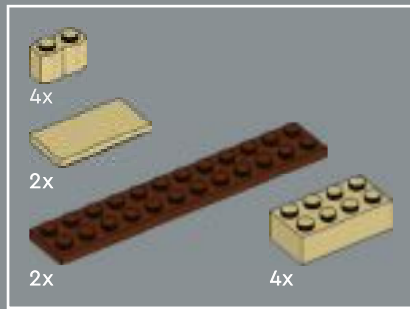

83

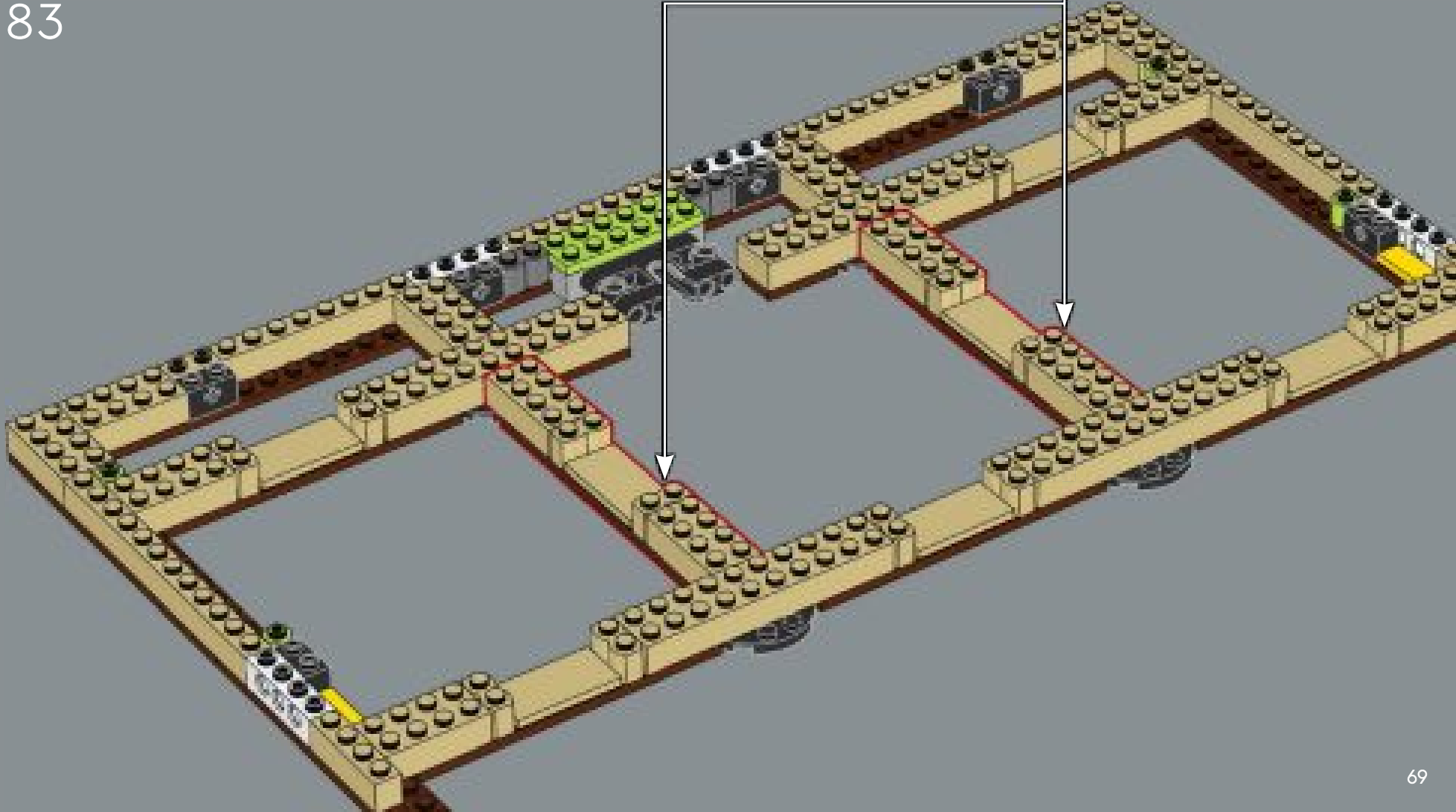

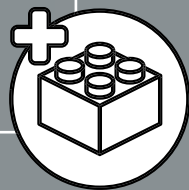
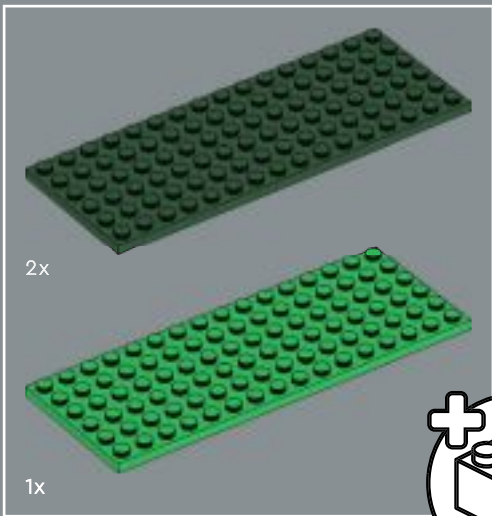

84

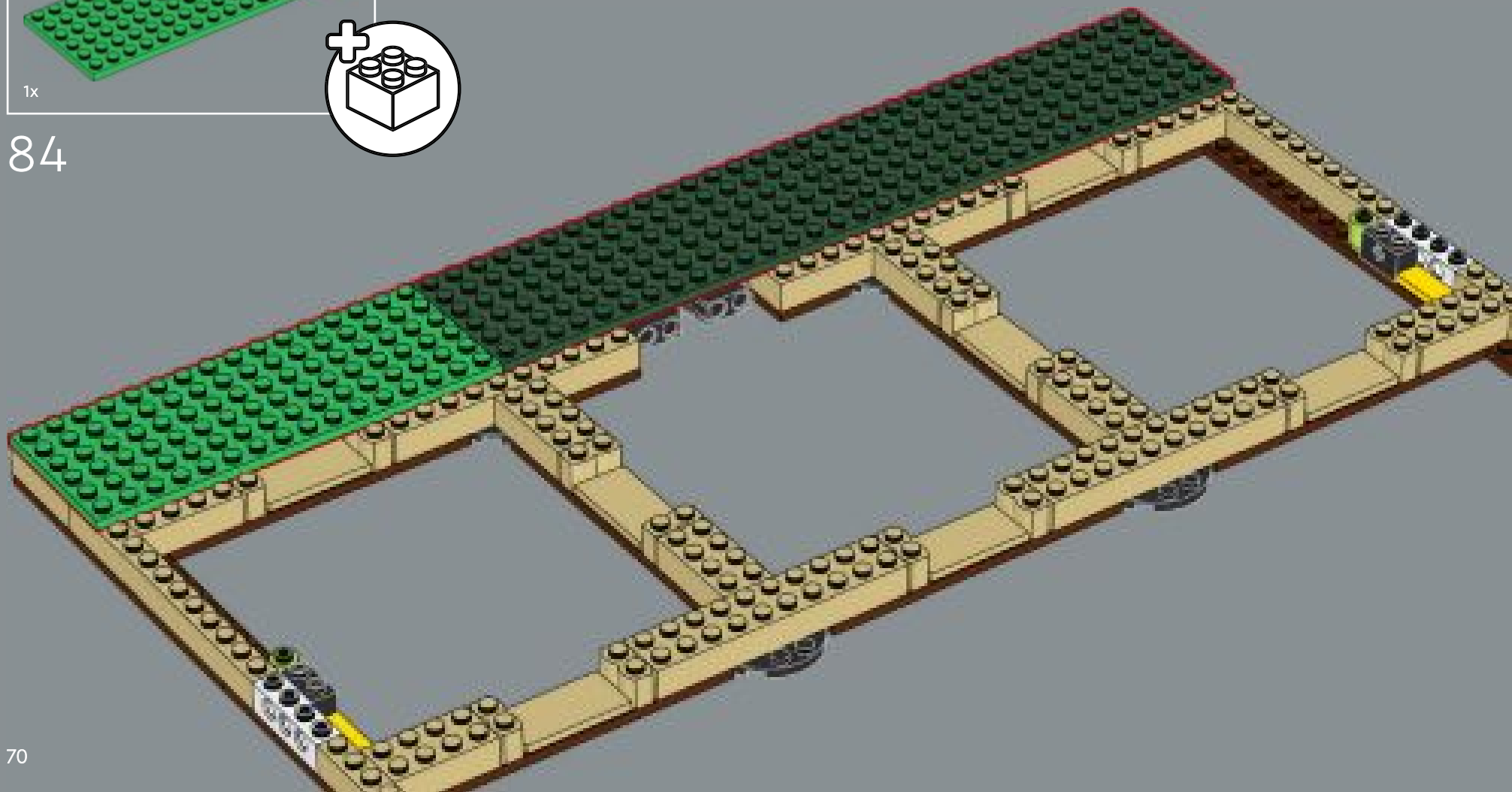

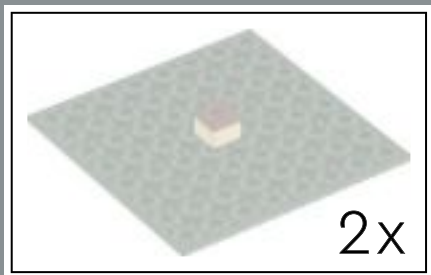

85

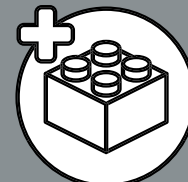
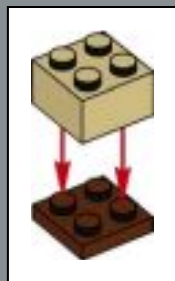

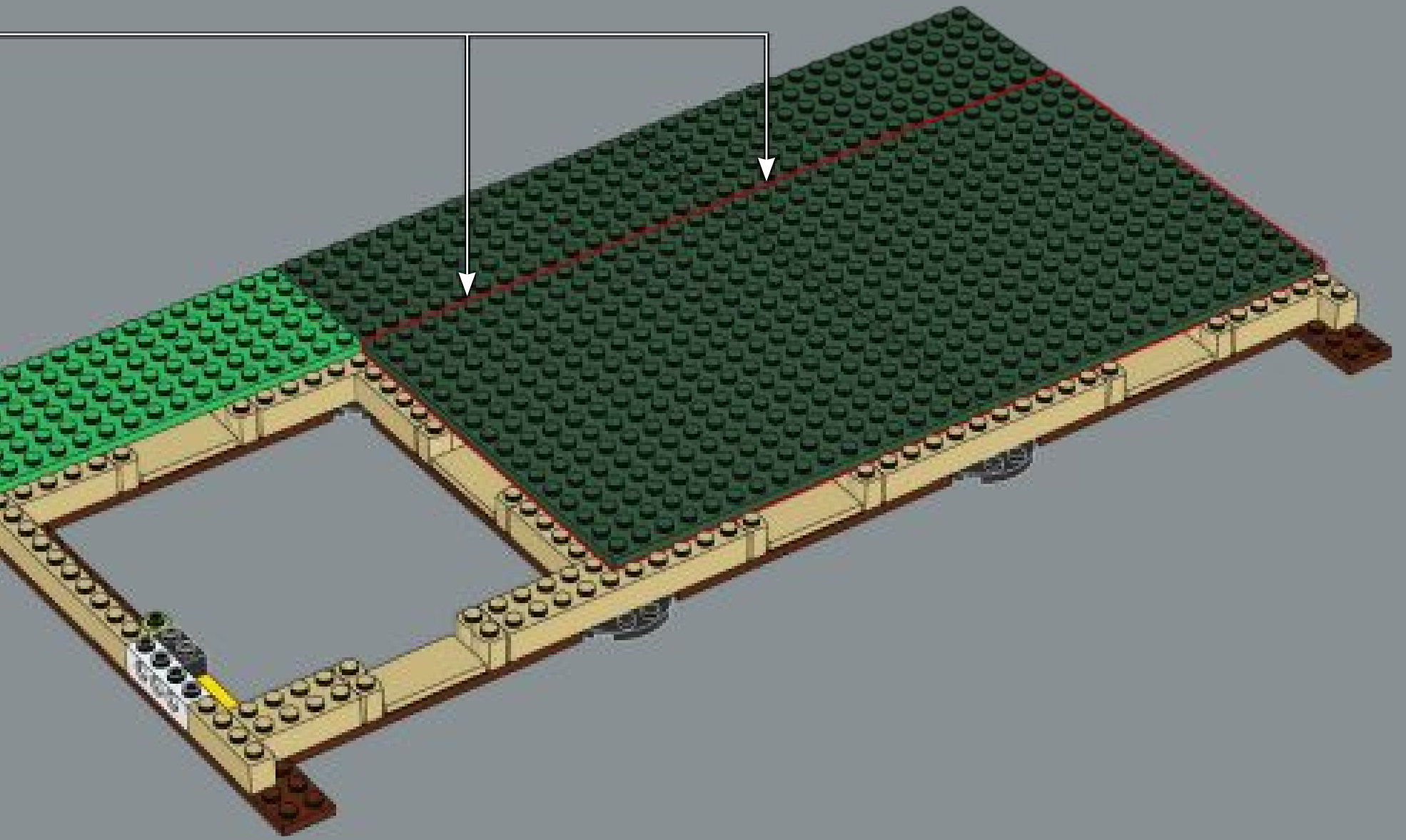



86

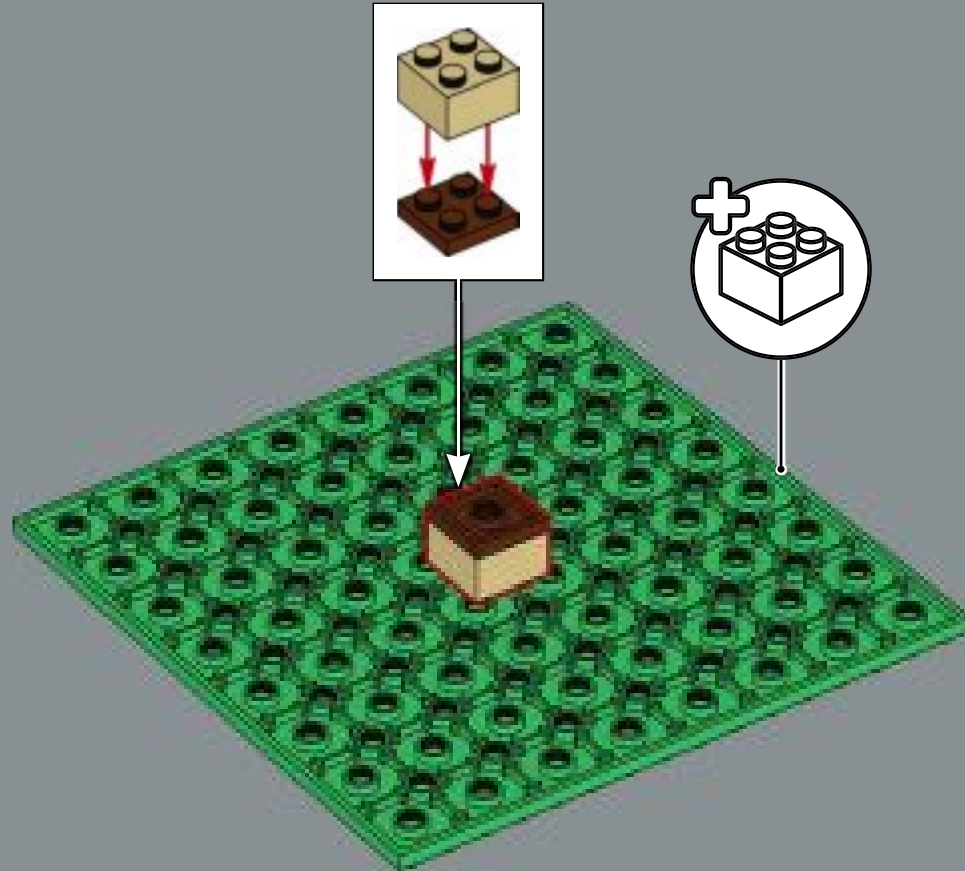

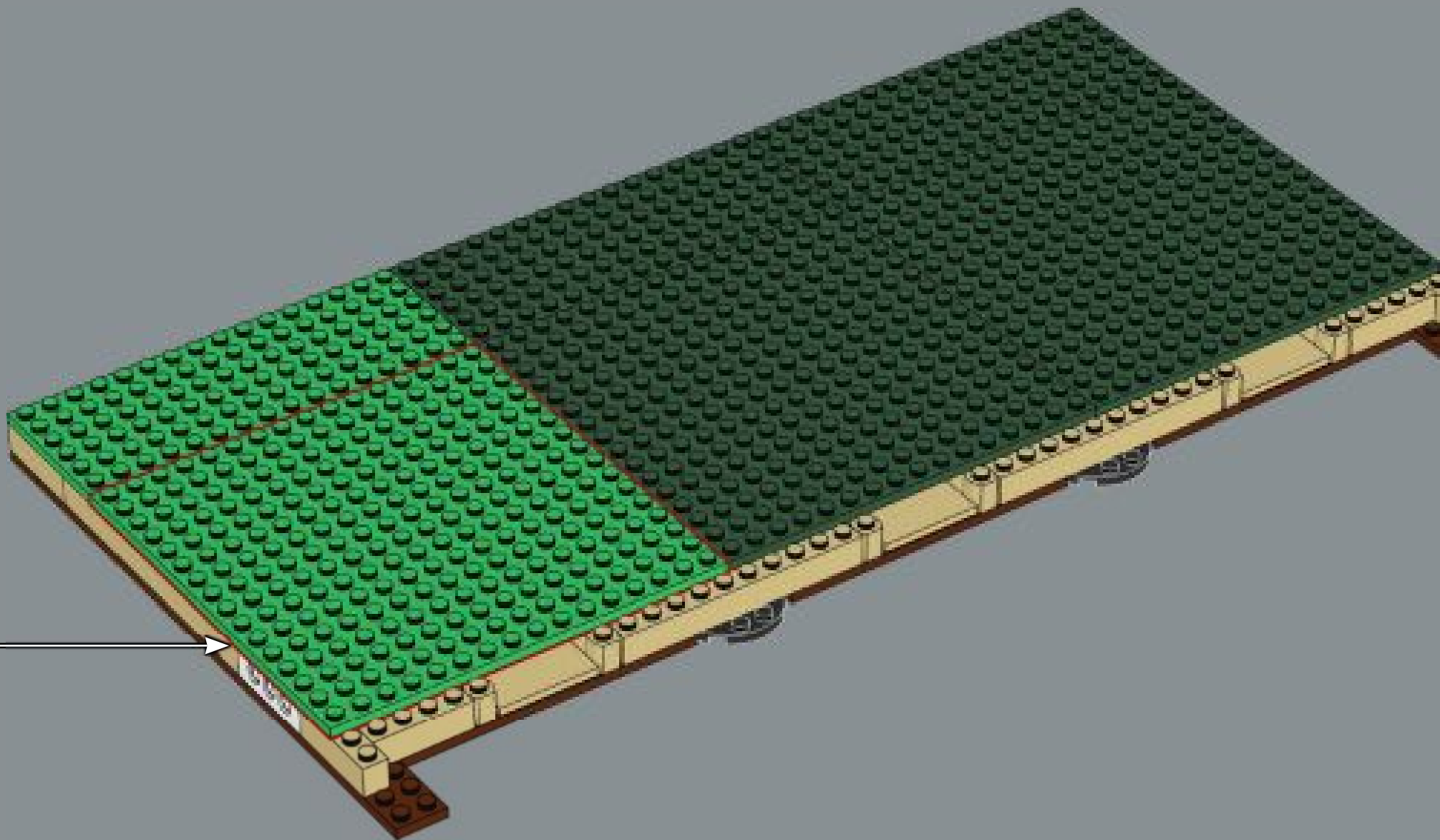



87

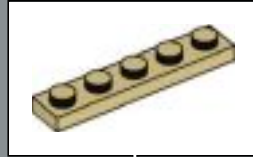

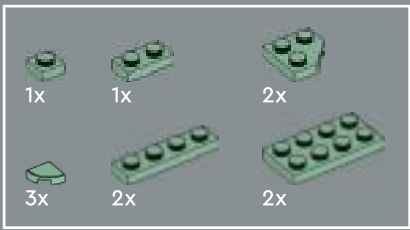

88



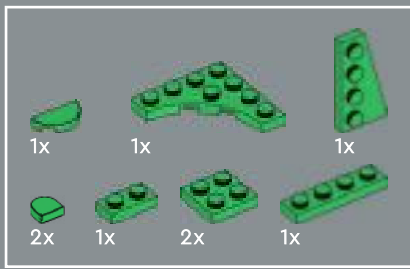

89



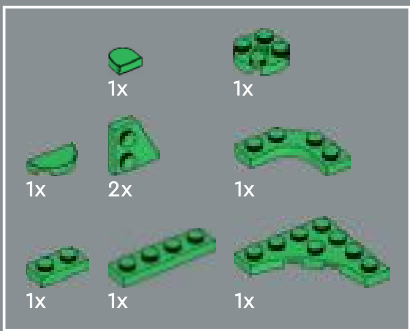

90



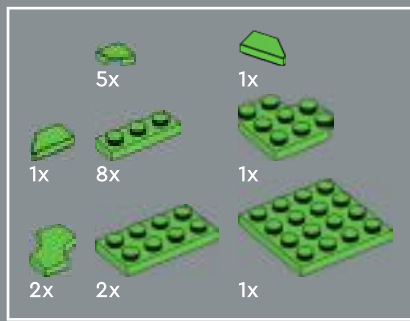

91



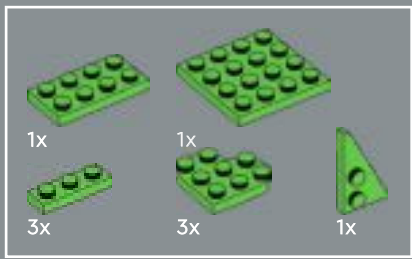

92





93



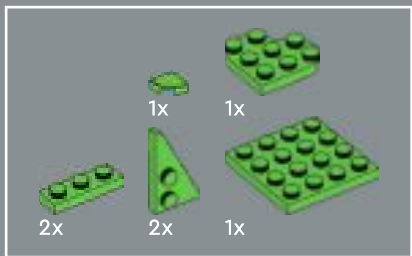

94





95



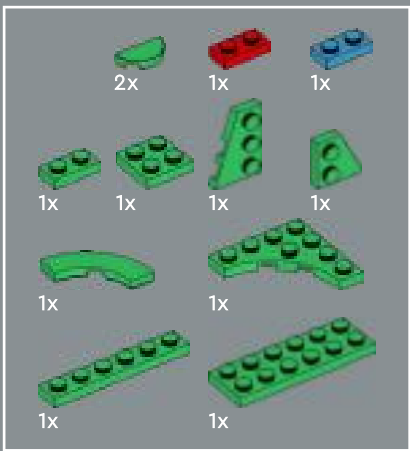

96



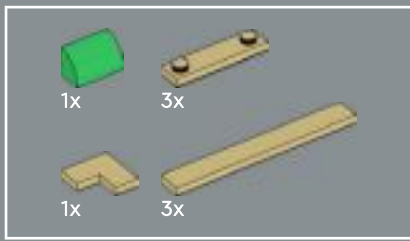

97

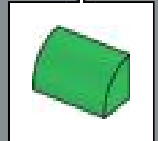



98

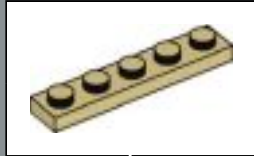

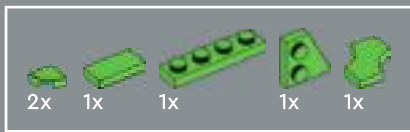

99



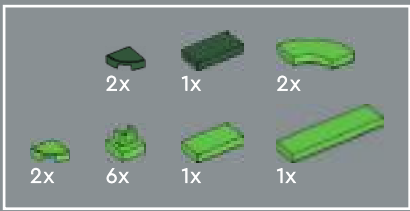

100

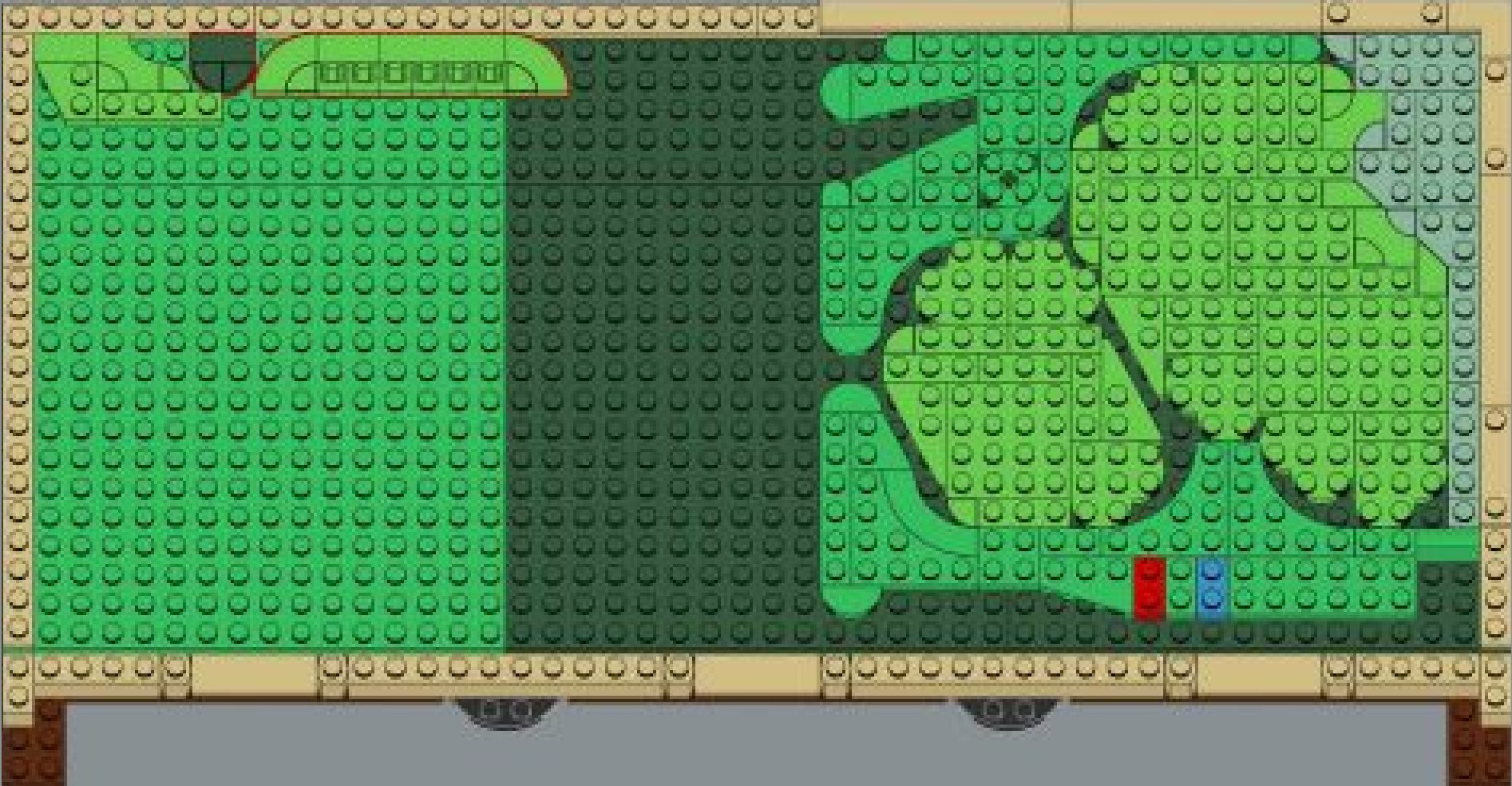

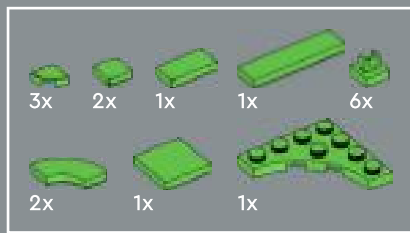

101



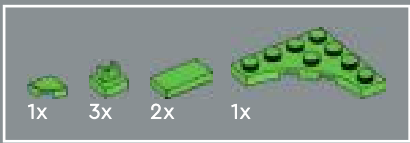

102

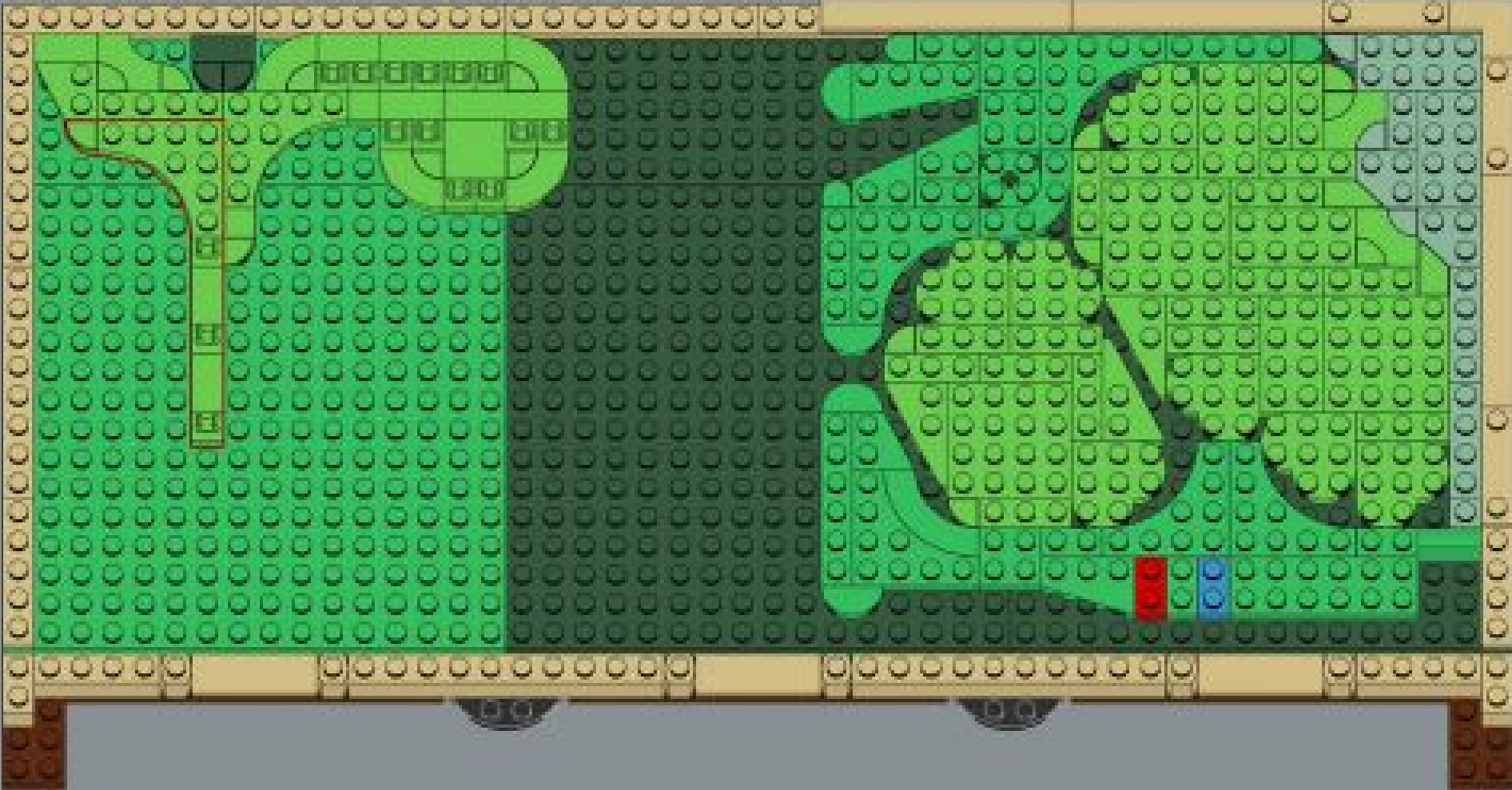

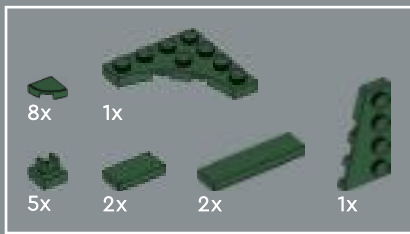

103



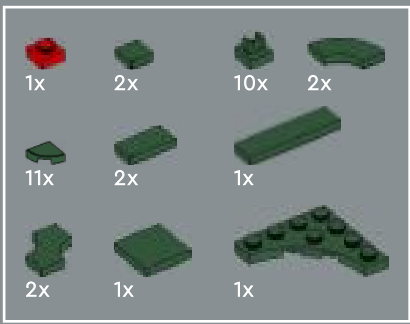

104

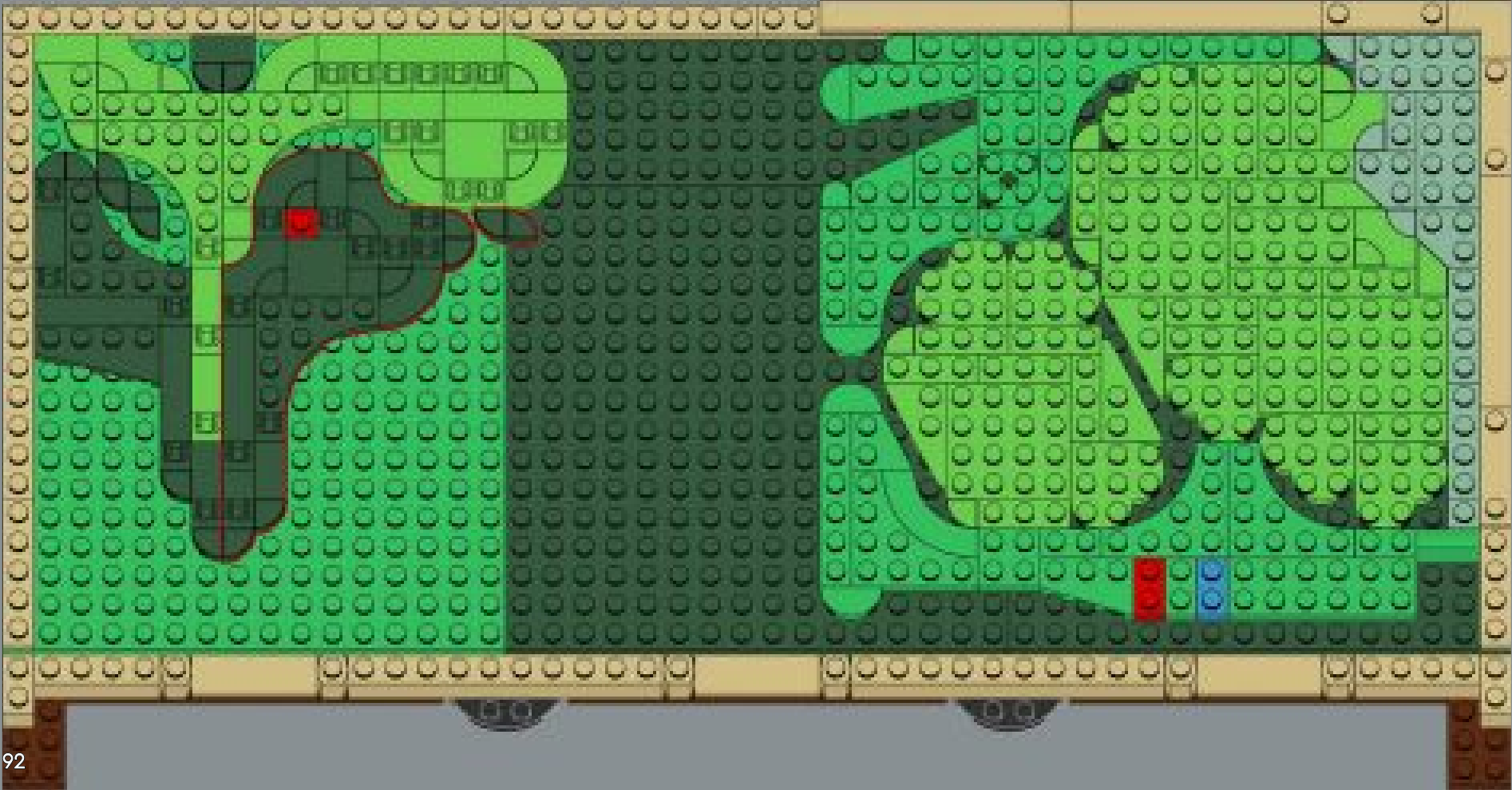

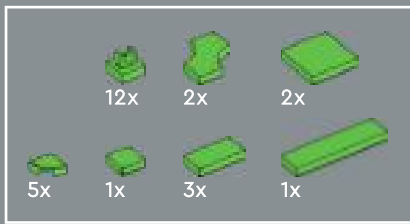

105

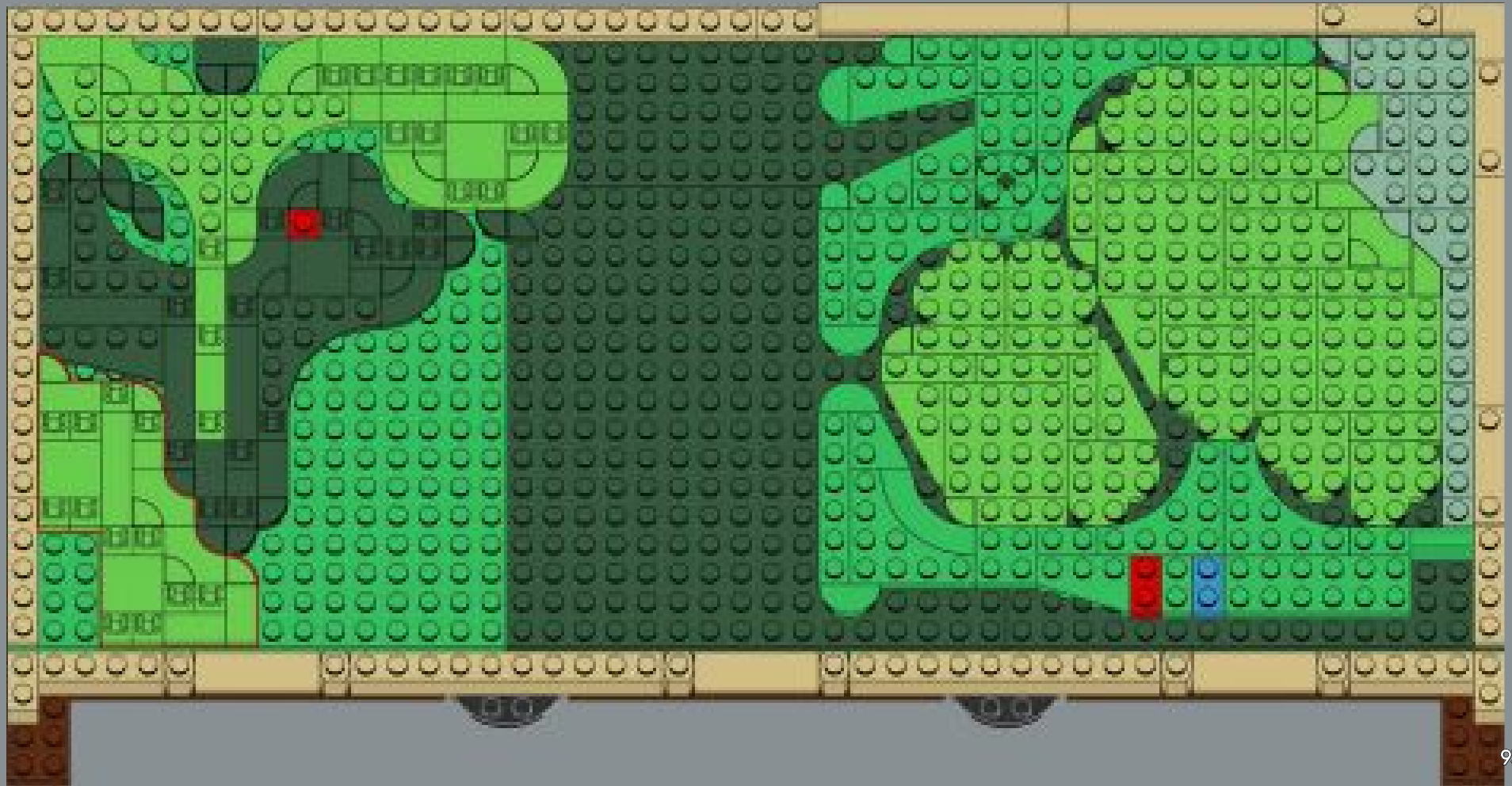



106

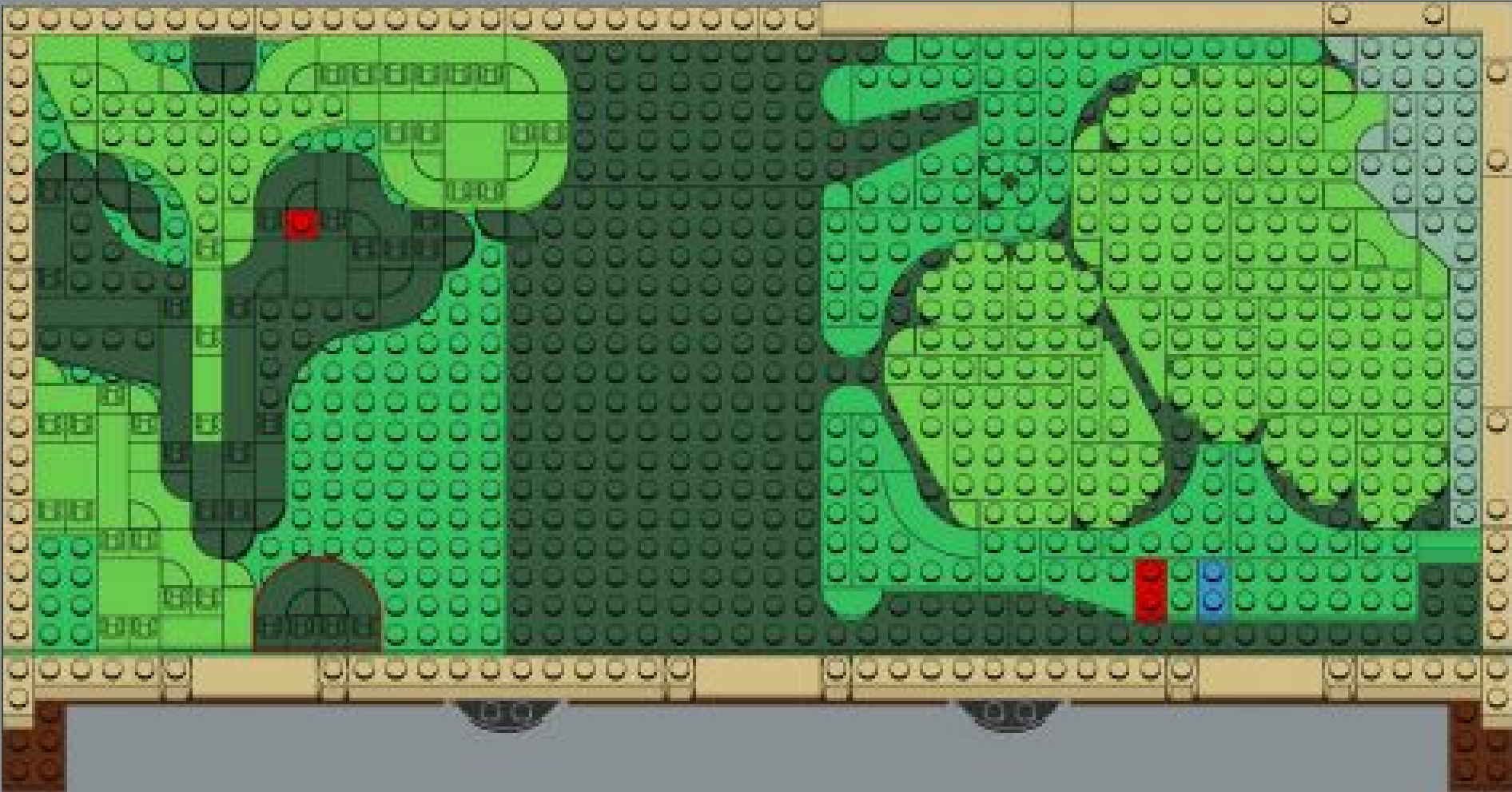



10x

107





11x

108

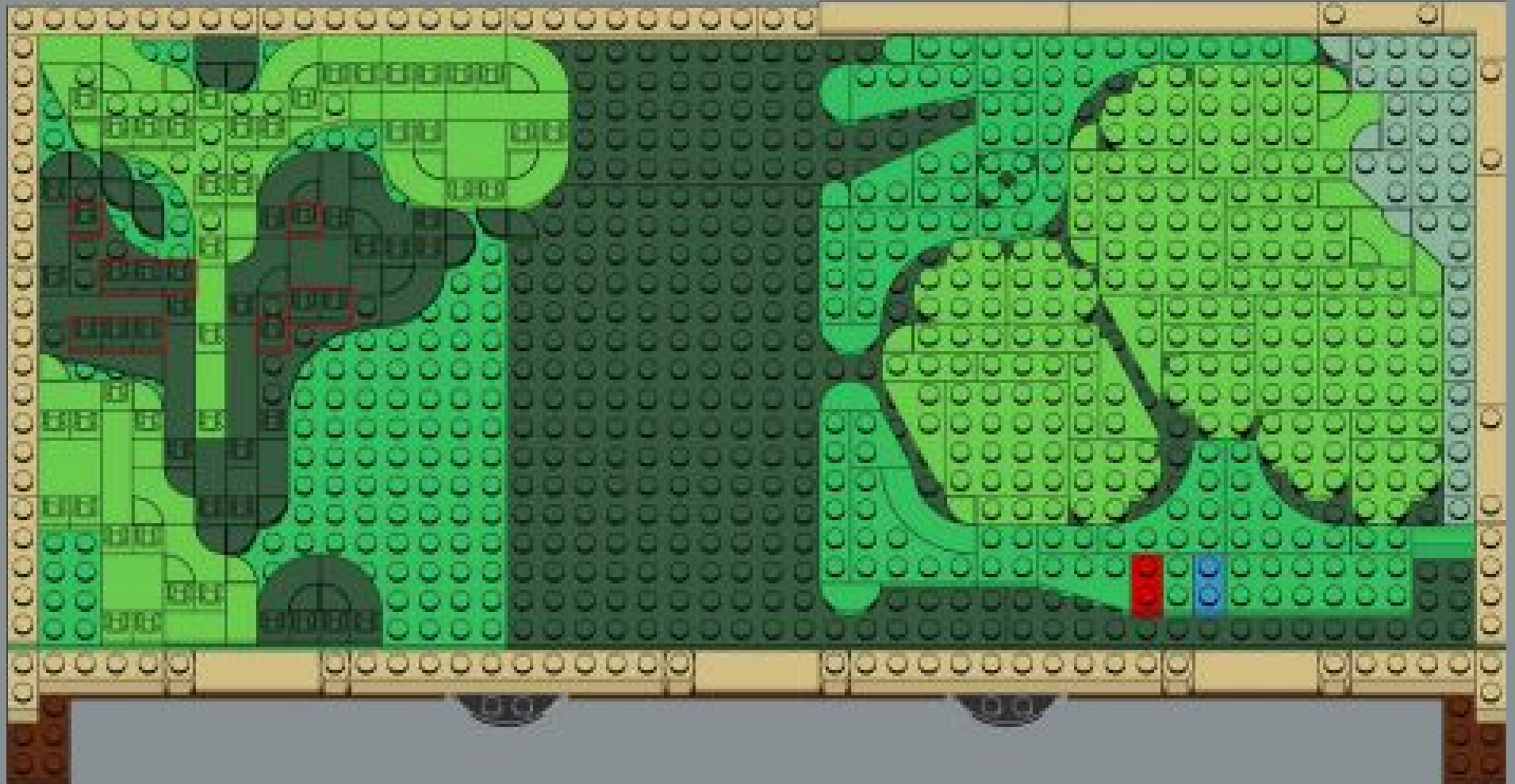



109

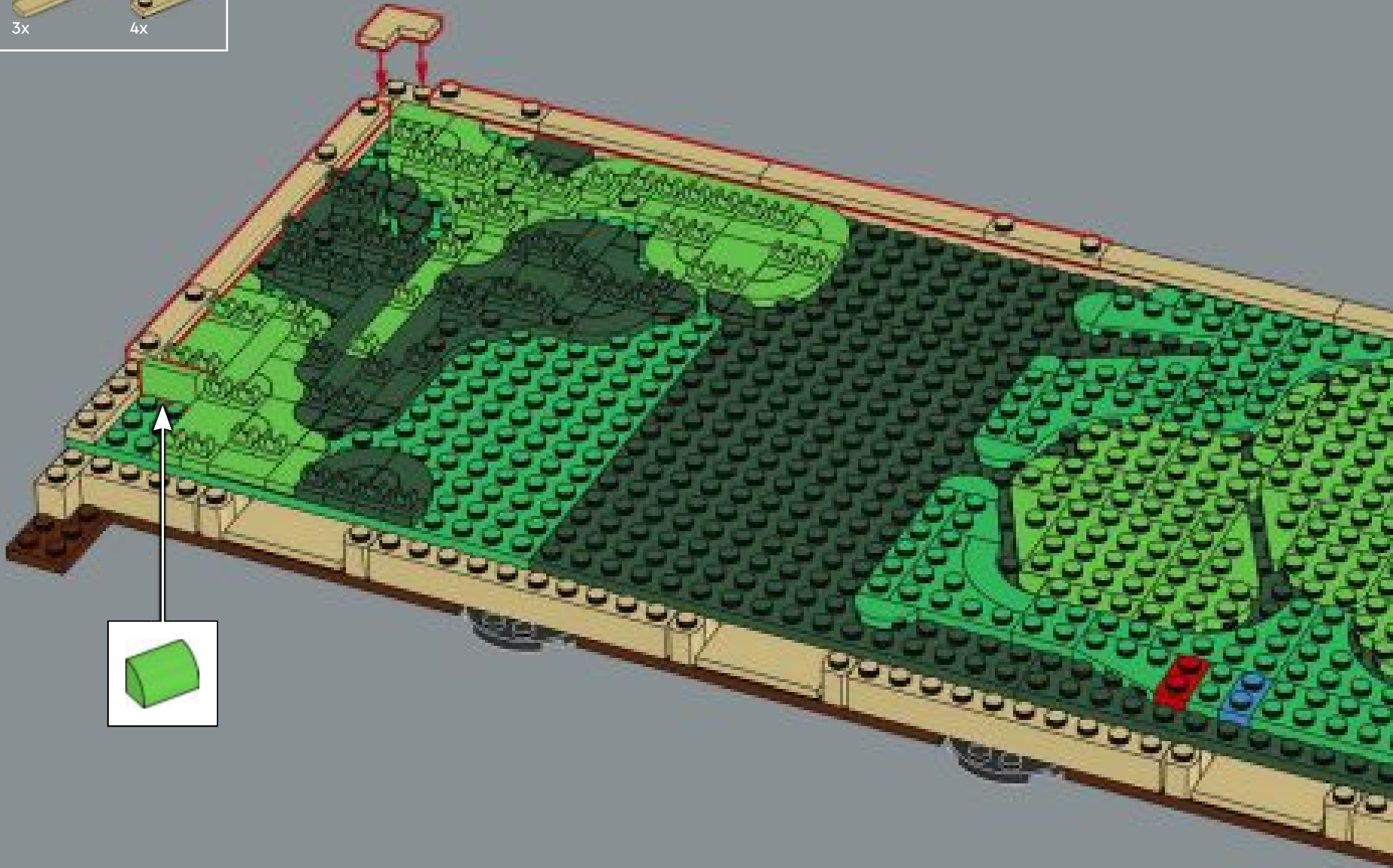

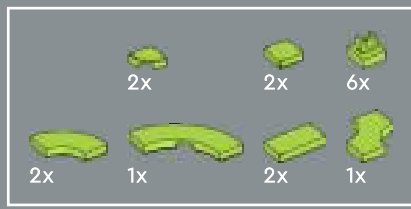

110



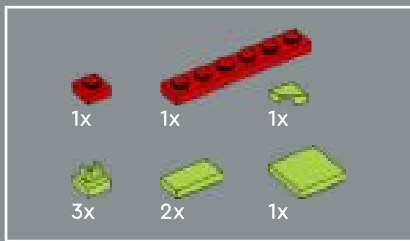

111



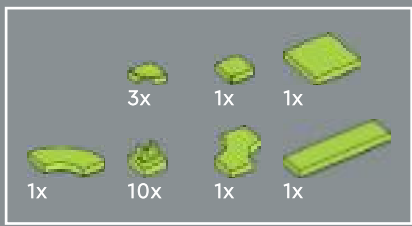

112

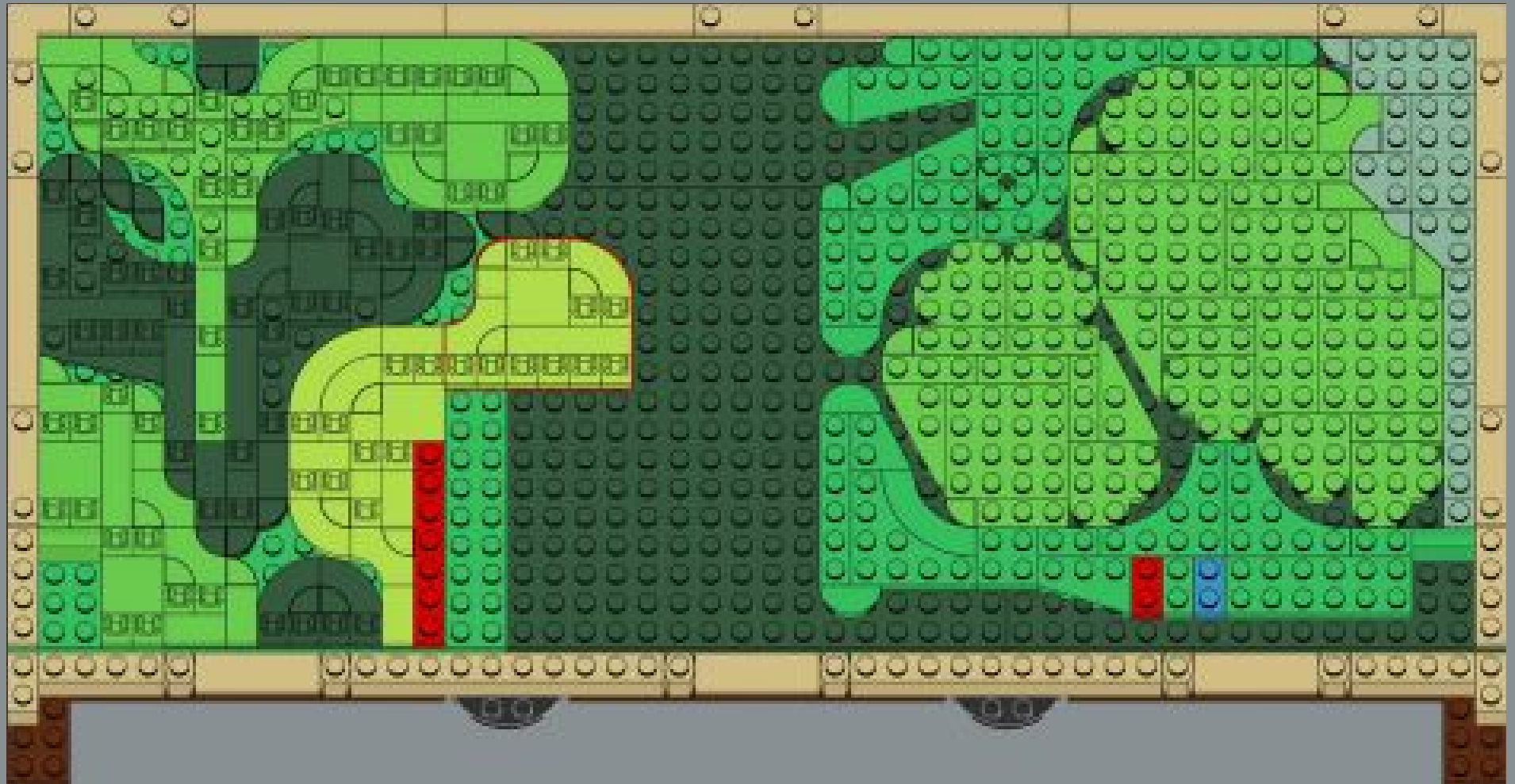

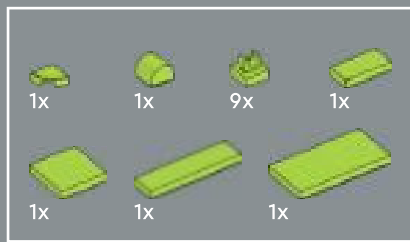

113

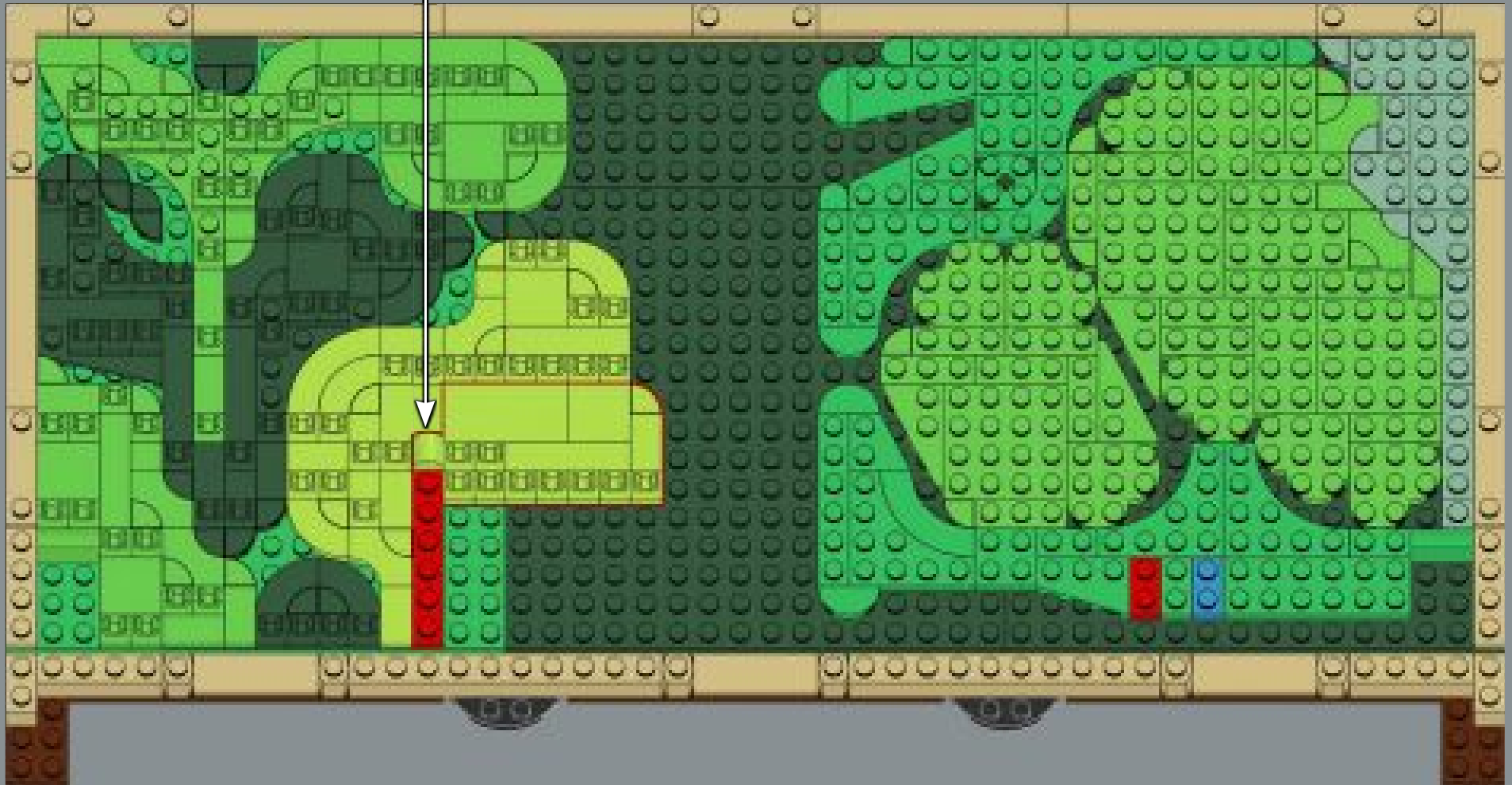

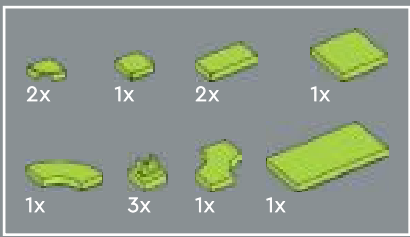

114

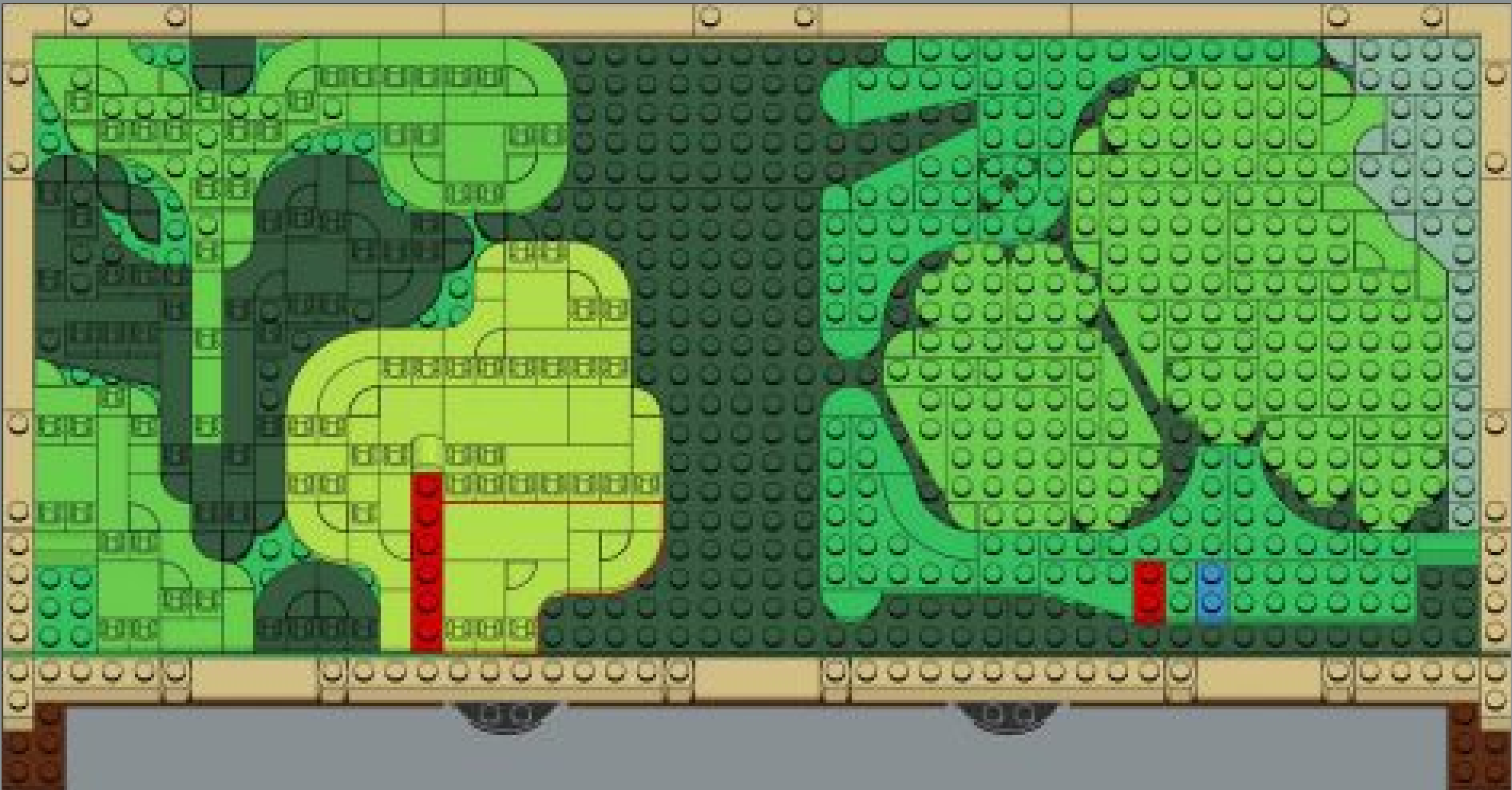

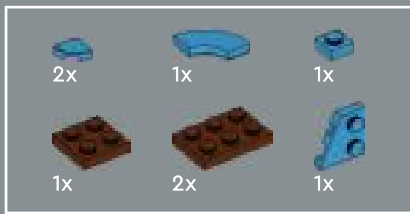

115

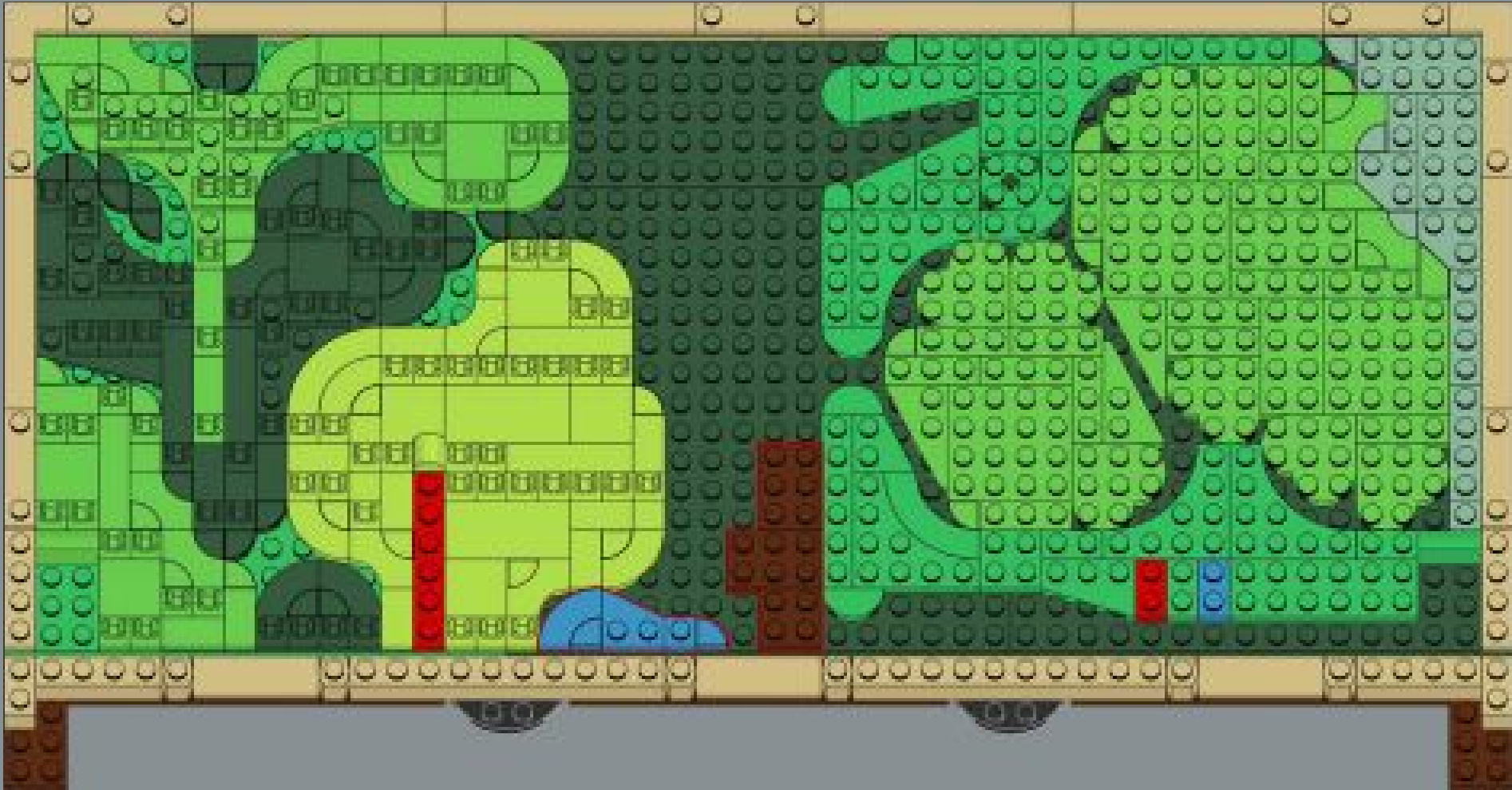



116

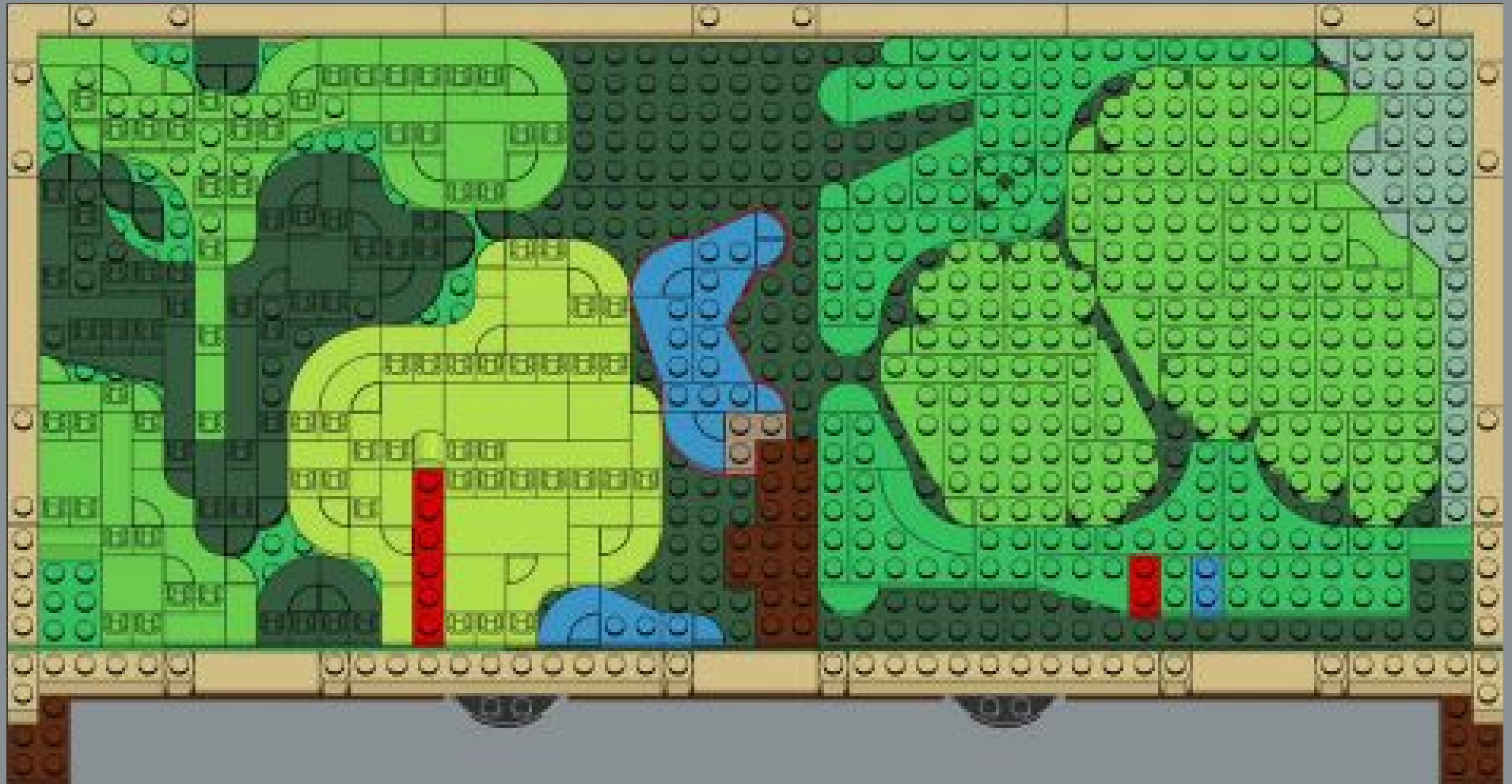

Six different shades of green, from dark green to azure, form the background layers.



117

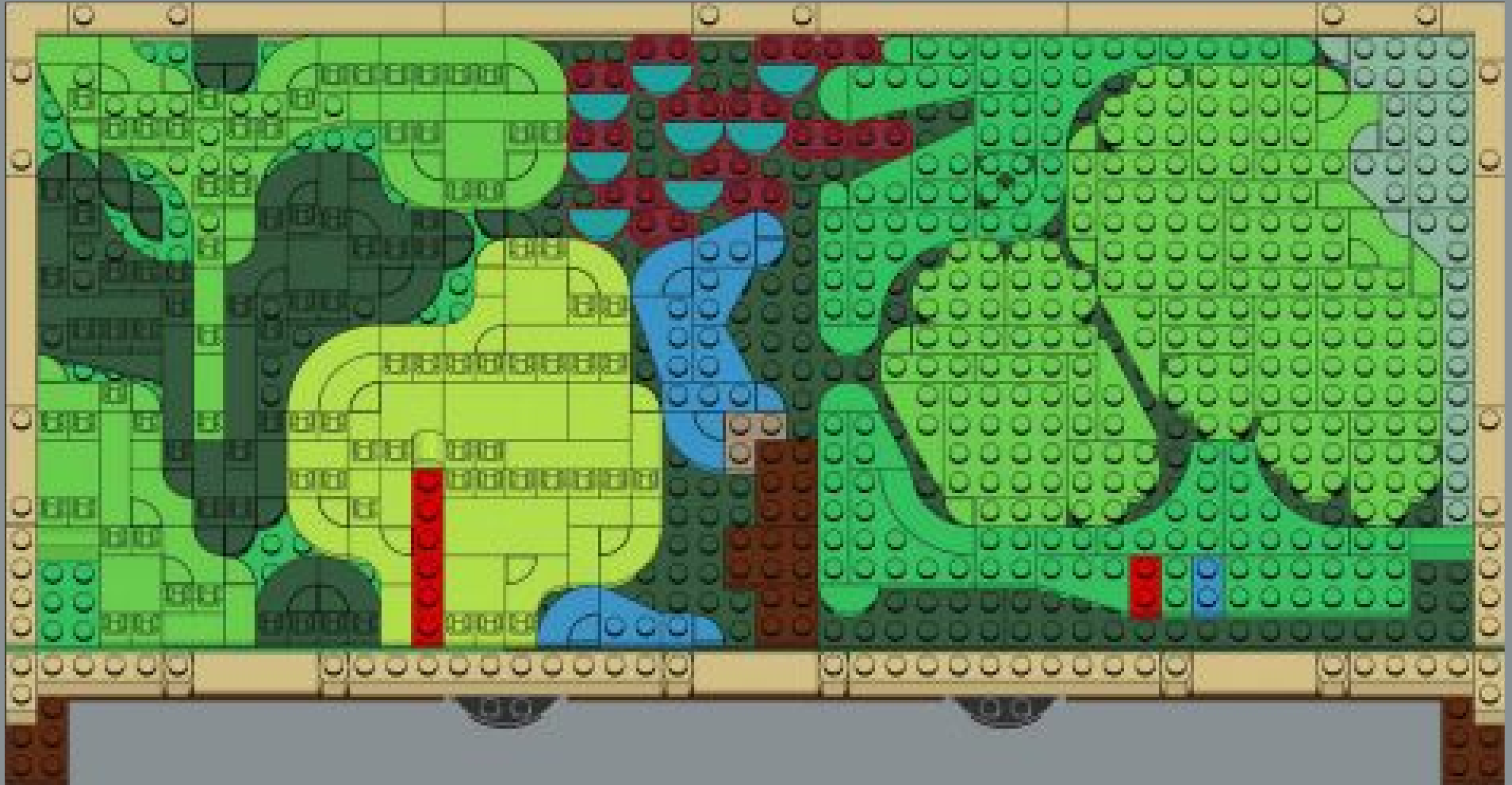



118

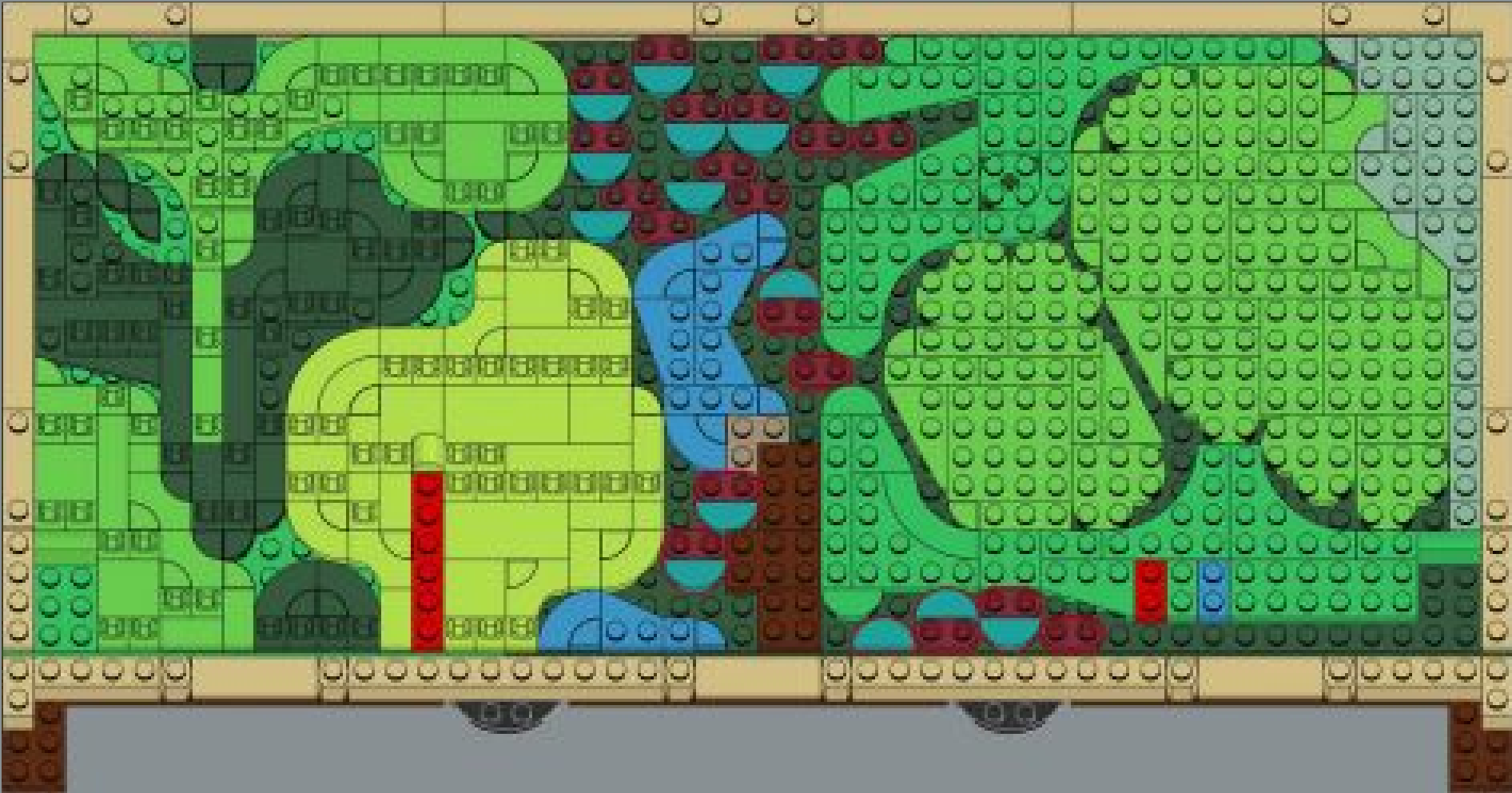

			
3x	2x	1x	8x

119

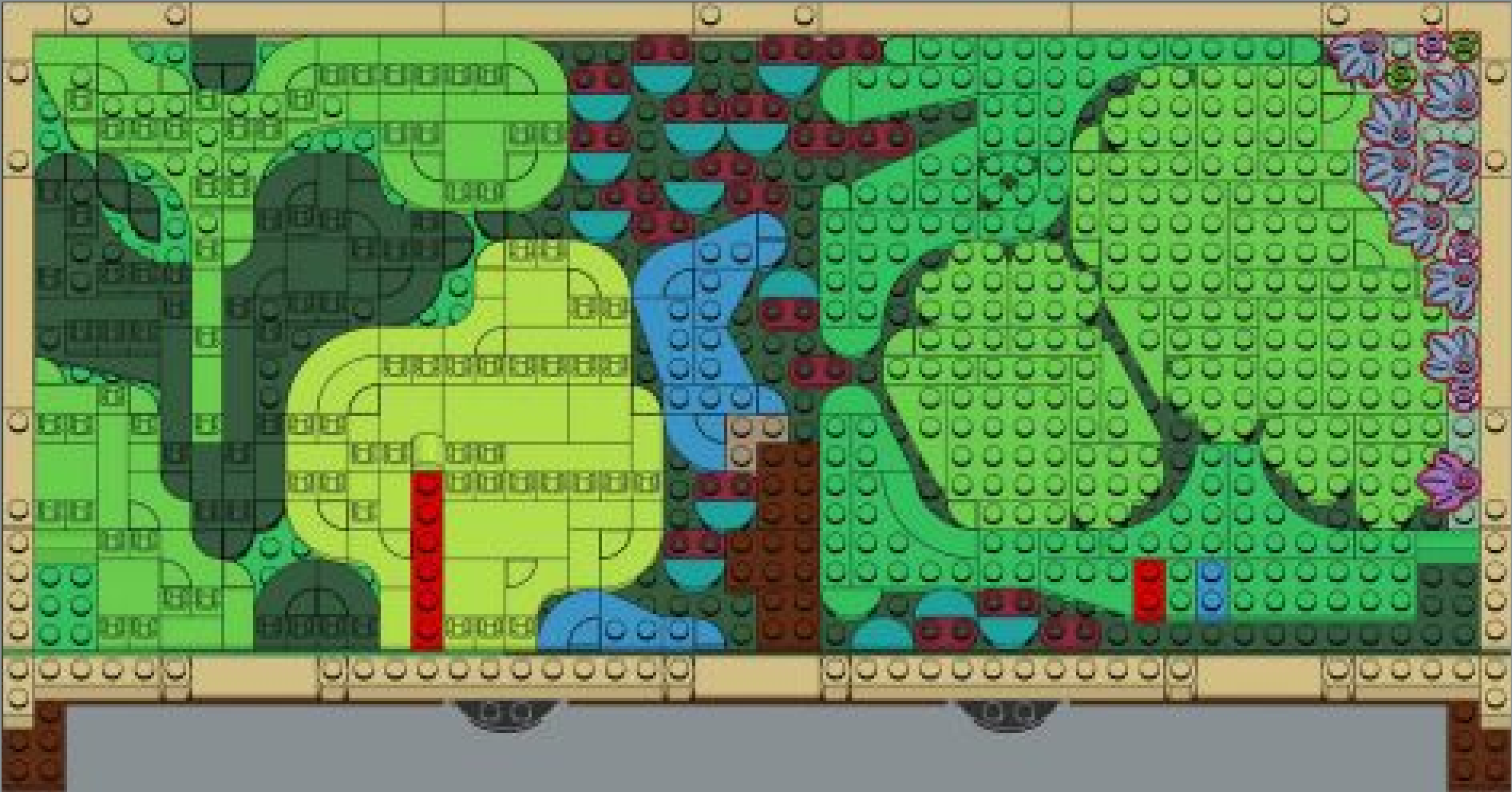



2x



1x



3x



2x

120

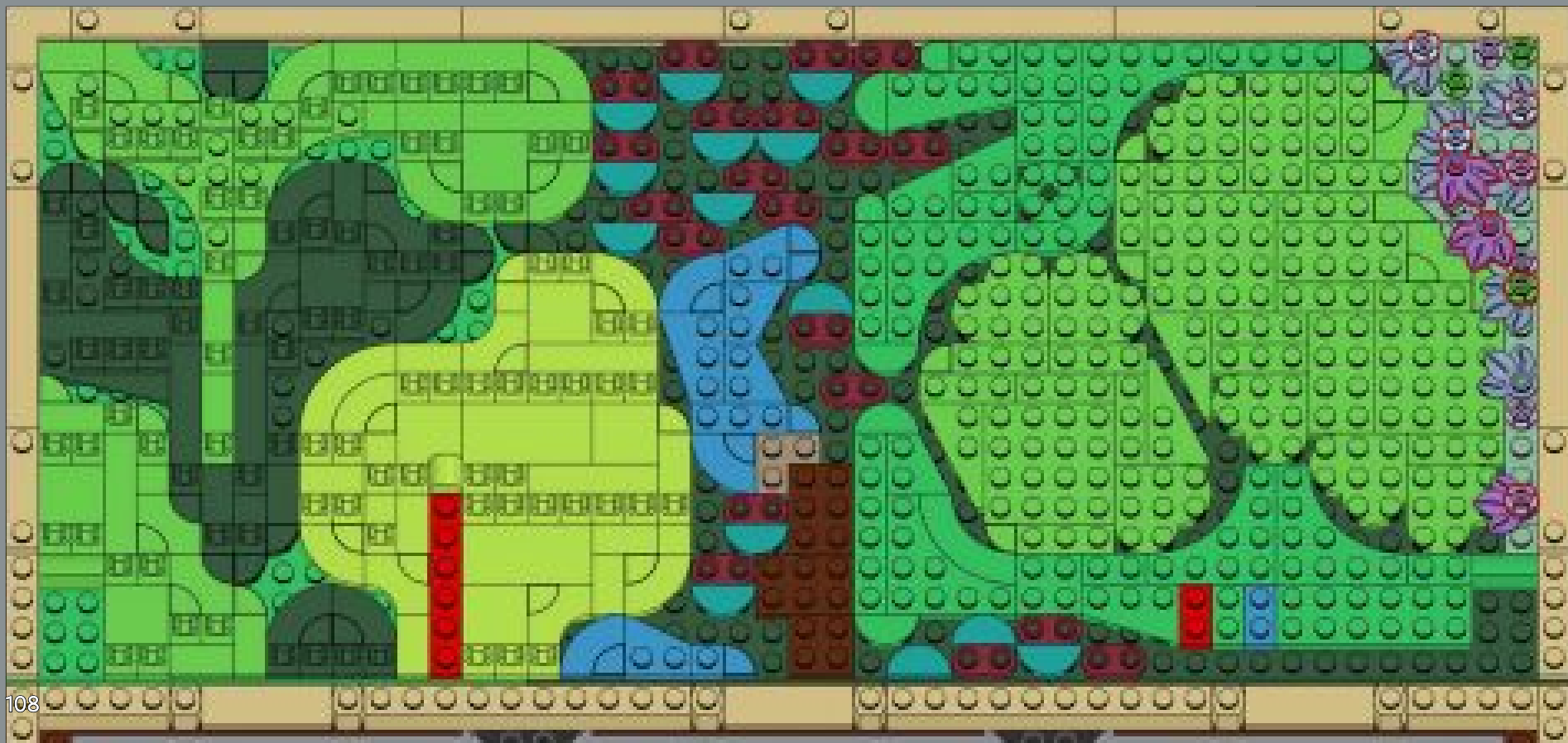



121





1x



8x



3x



1x

122

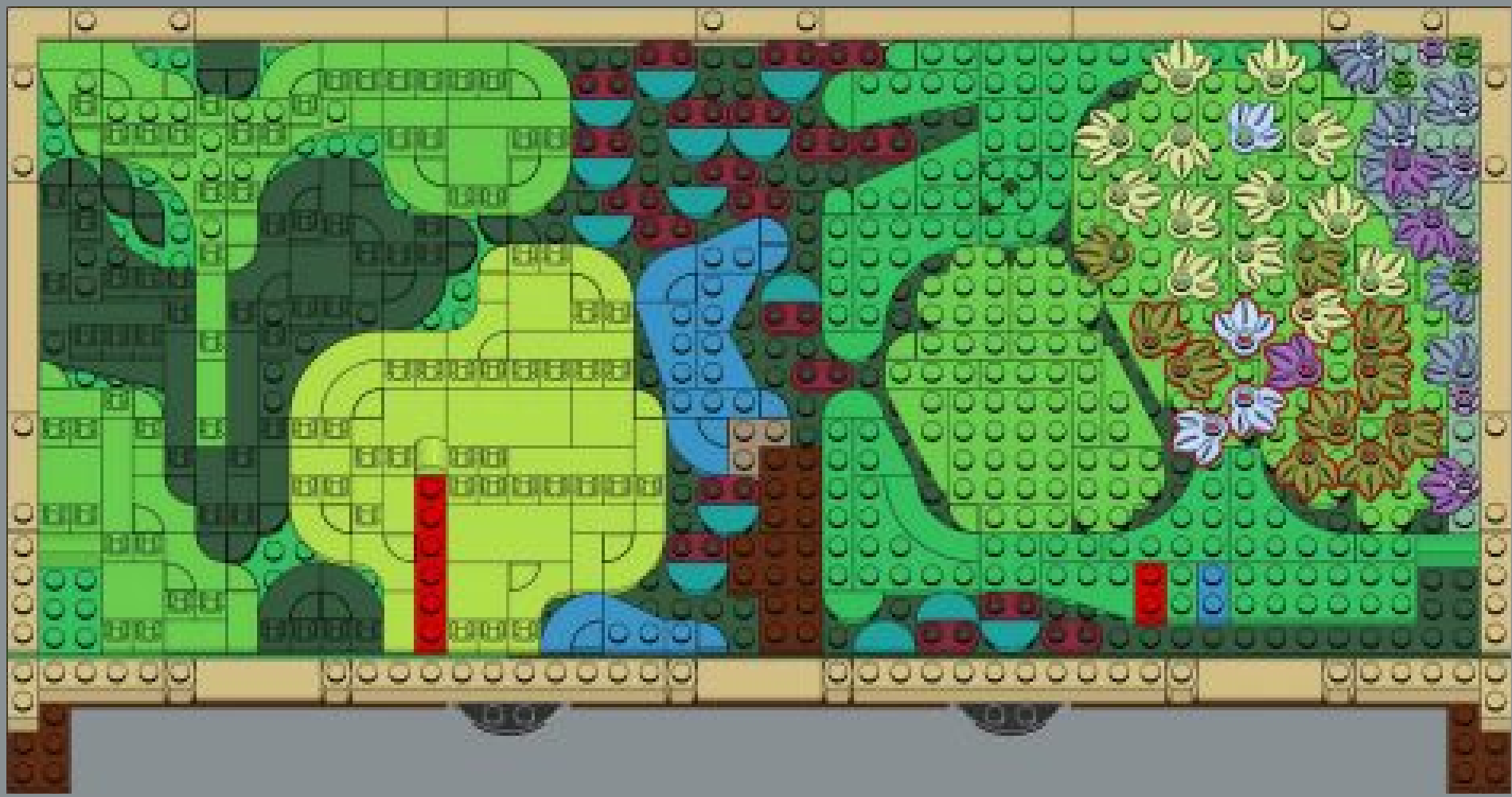



123

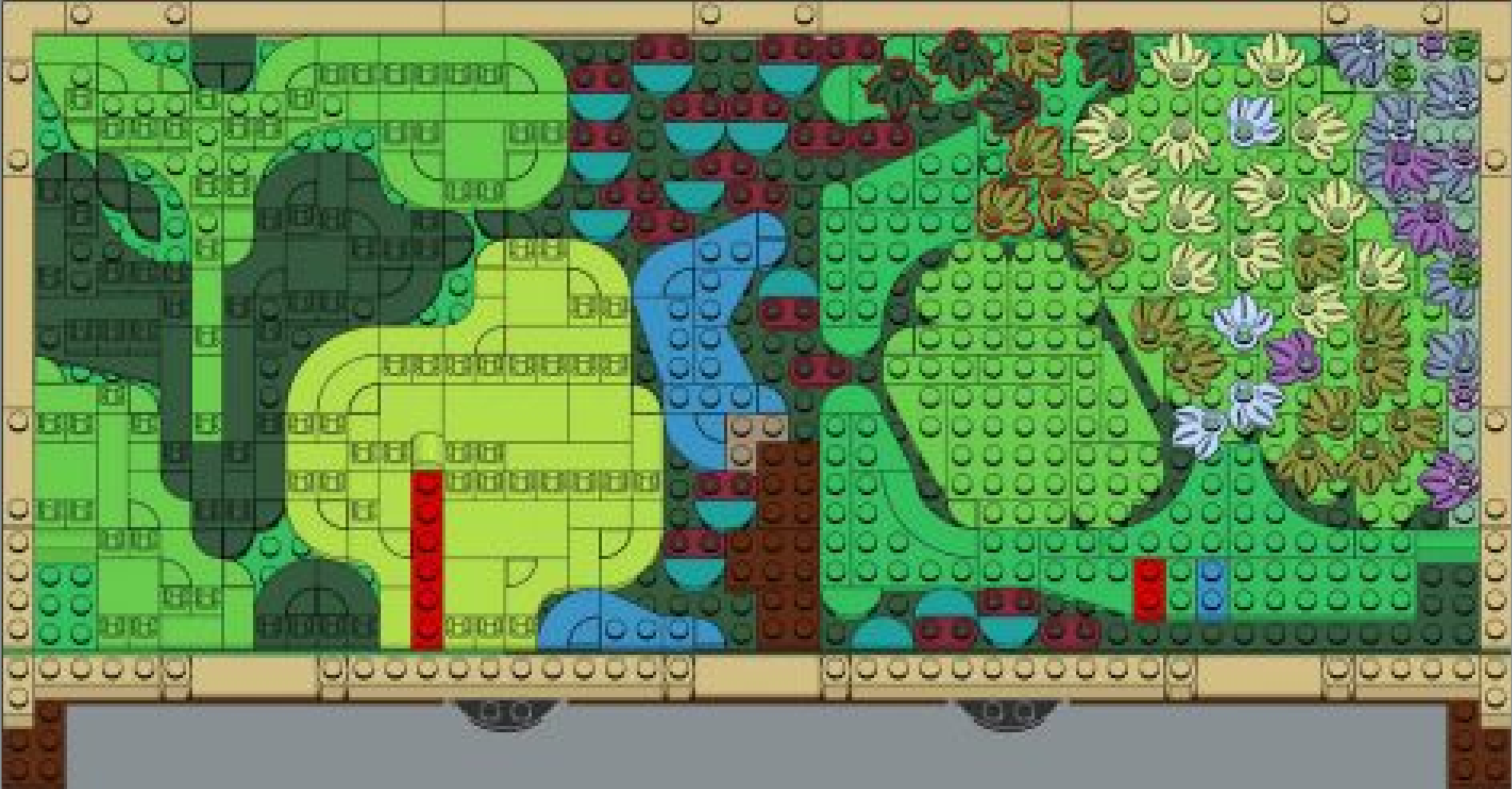

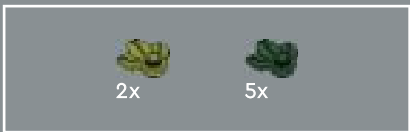

124





125



4x

6x

126





127

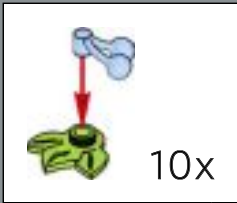



We've used LEGO® butterfly elements to evoke the lush natural environment that Monet created at Giverny, and to replicate the brushstrokes in the painting.

128





129

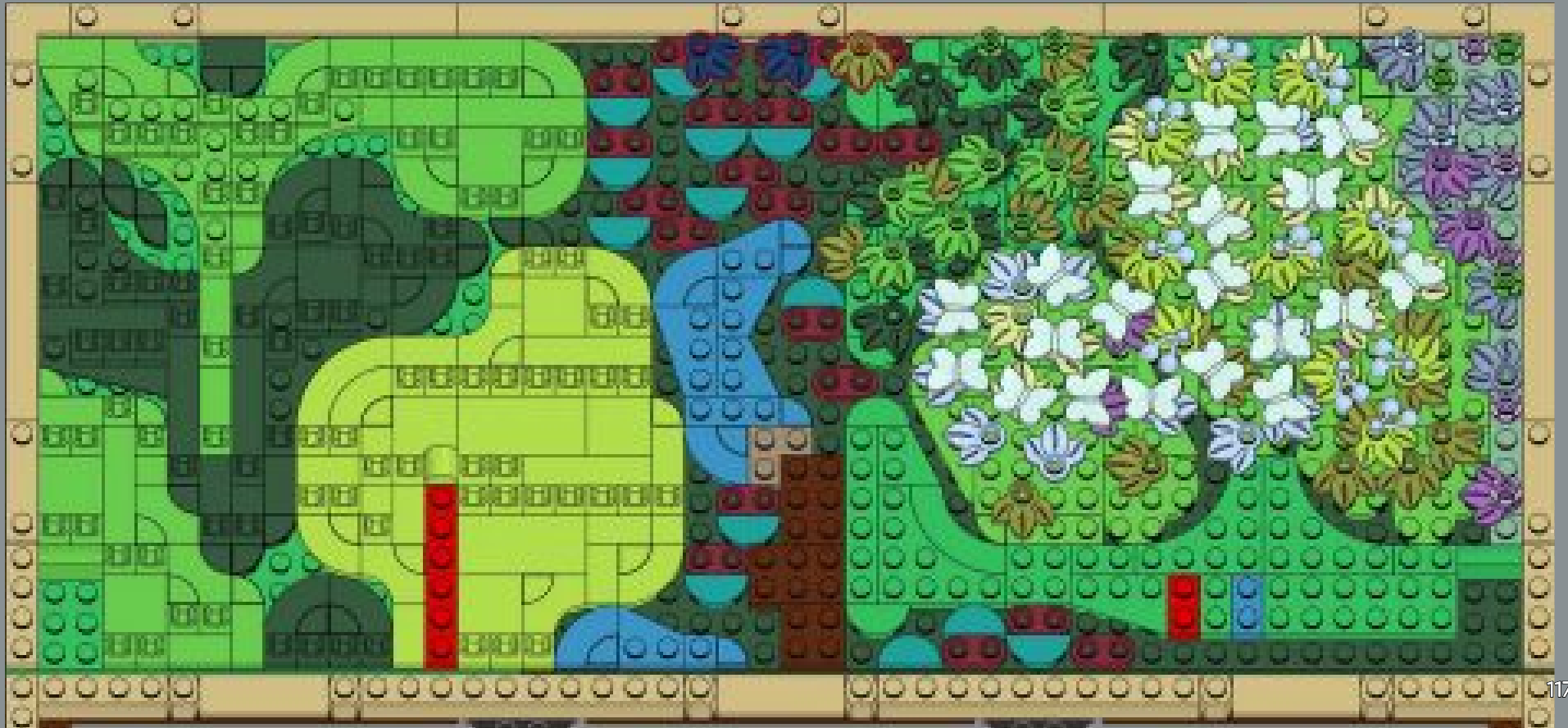



130

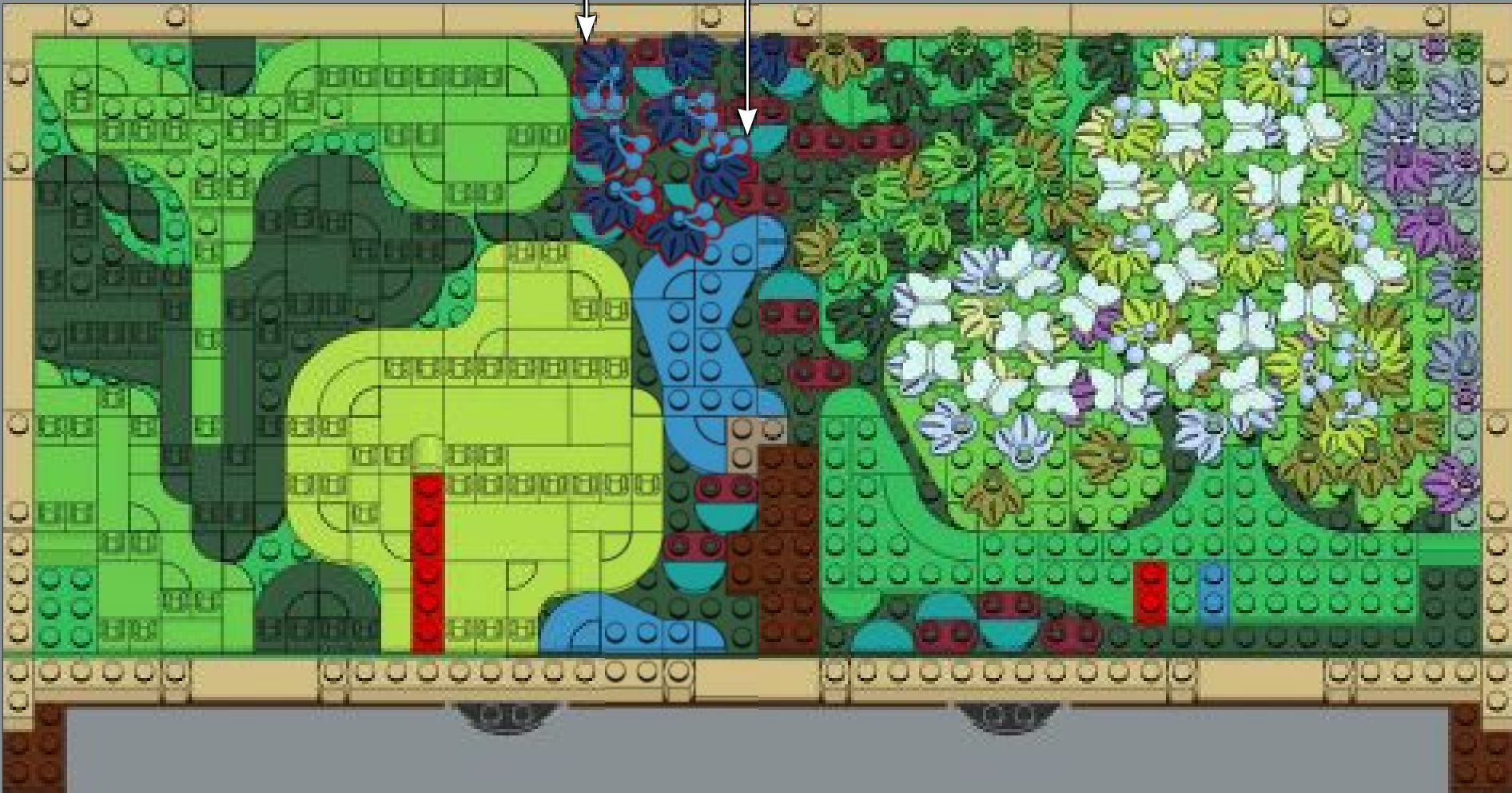
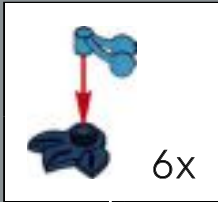

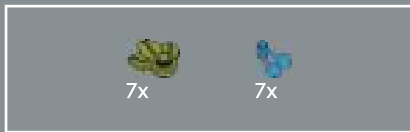

131

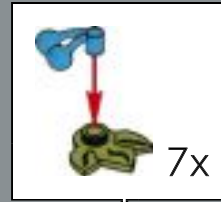

A LEGO® cherry tree element symbolises the cherry trees that Monet planted near his water garden as an expression of his love of Japanese art and culture.



1x



1x

132





133



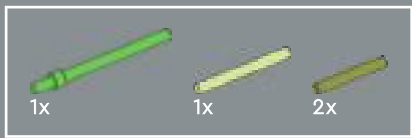

134



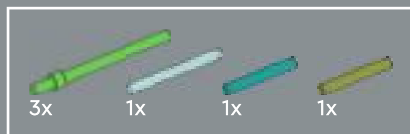

135

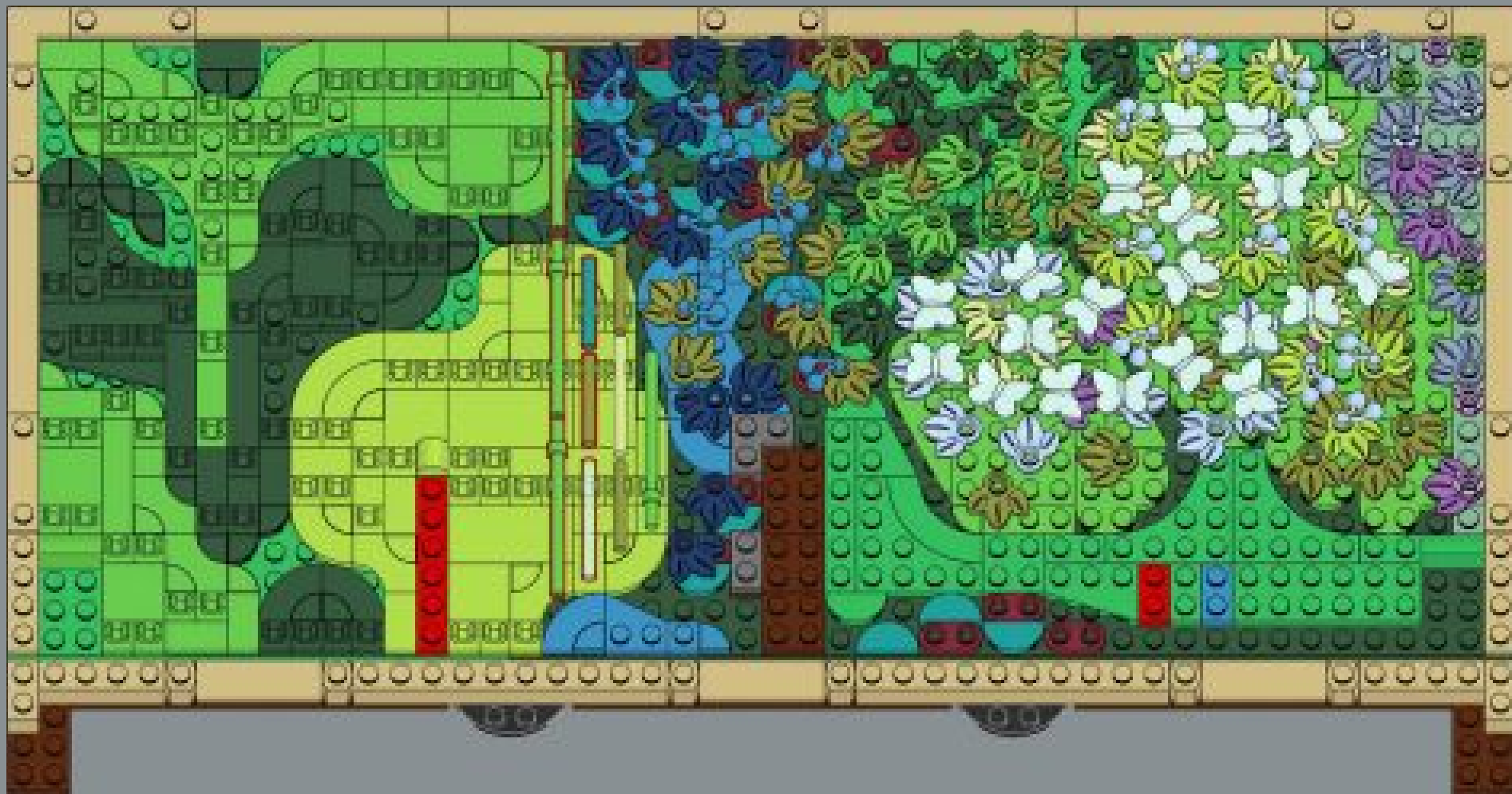



136

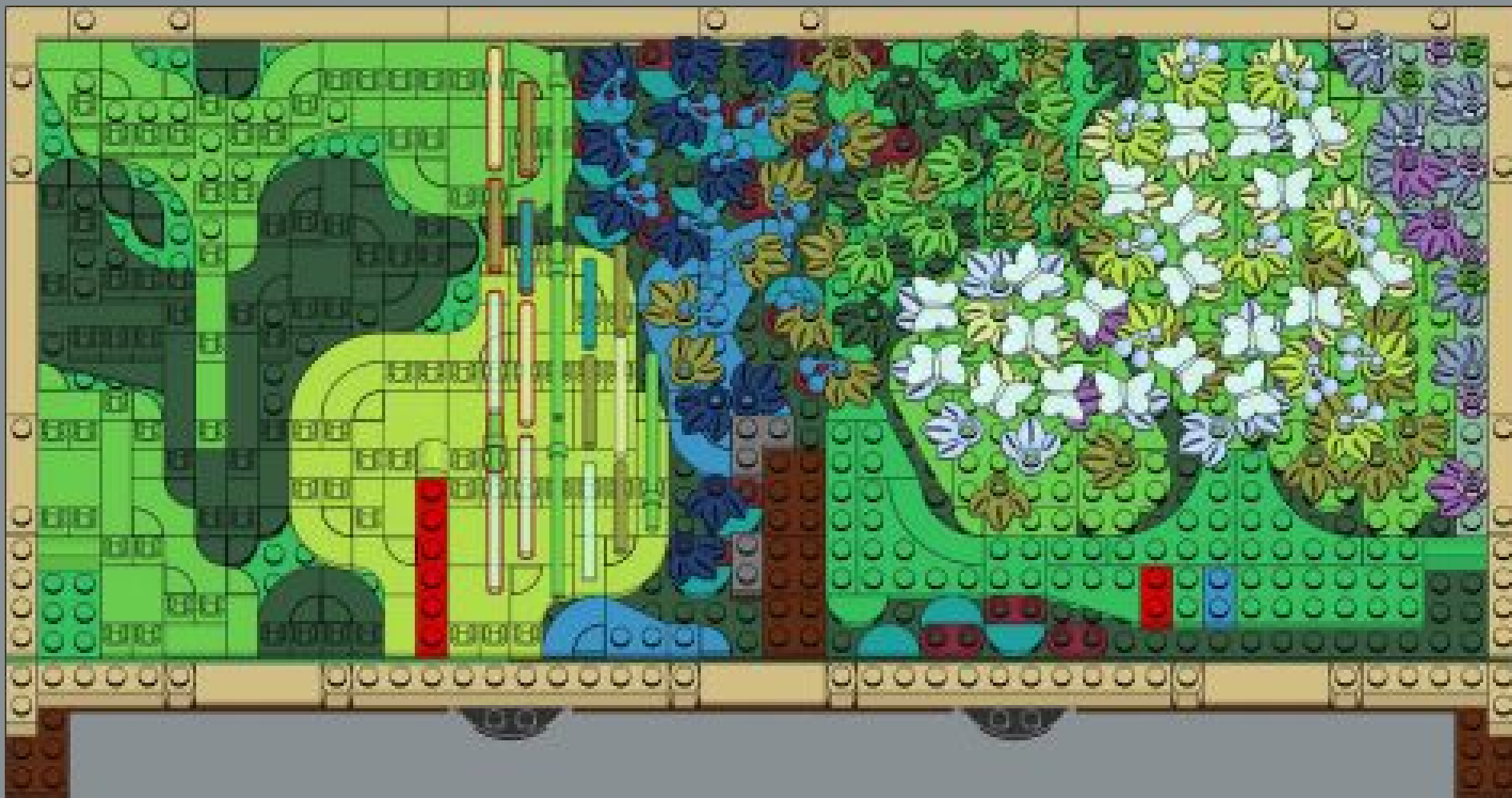

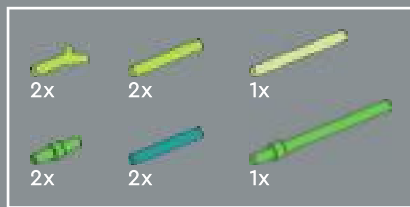

137



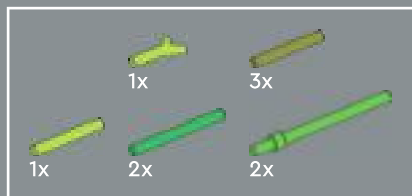

138



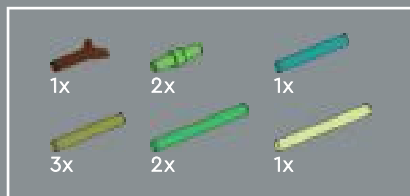

139



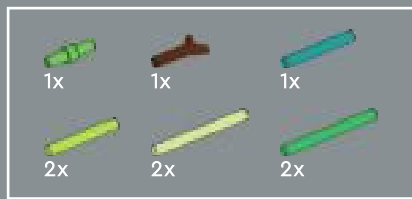

140



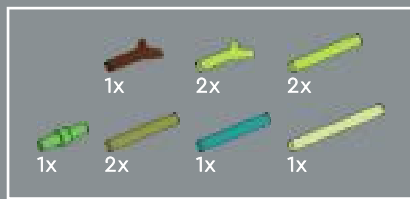

141



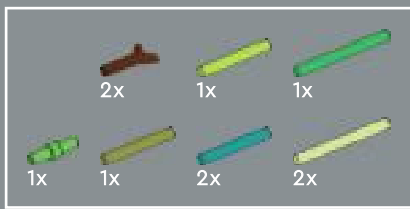

142



LEGO® bar elements are used in different shapes and sizes, with the occasional carrot-top element added to the mix to represent vertical brushstrokes.

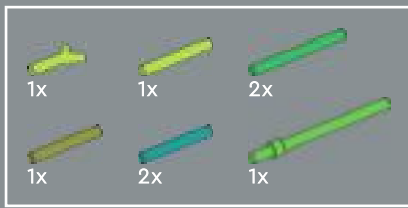

143



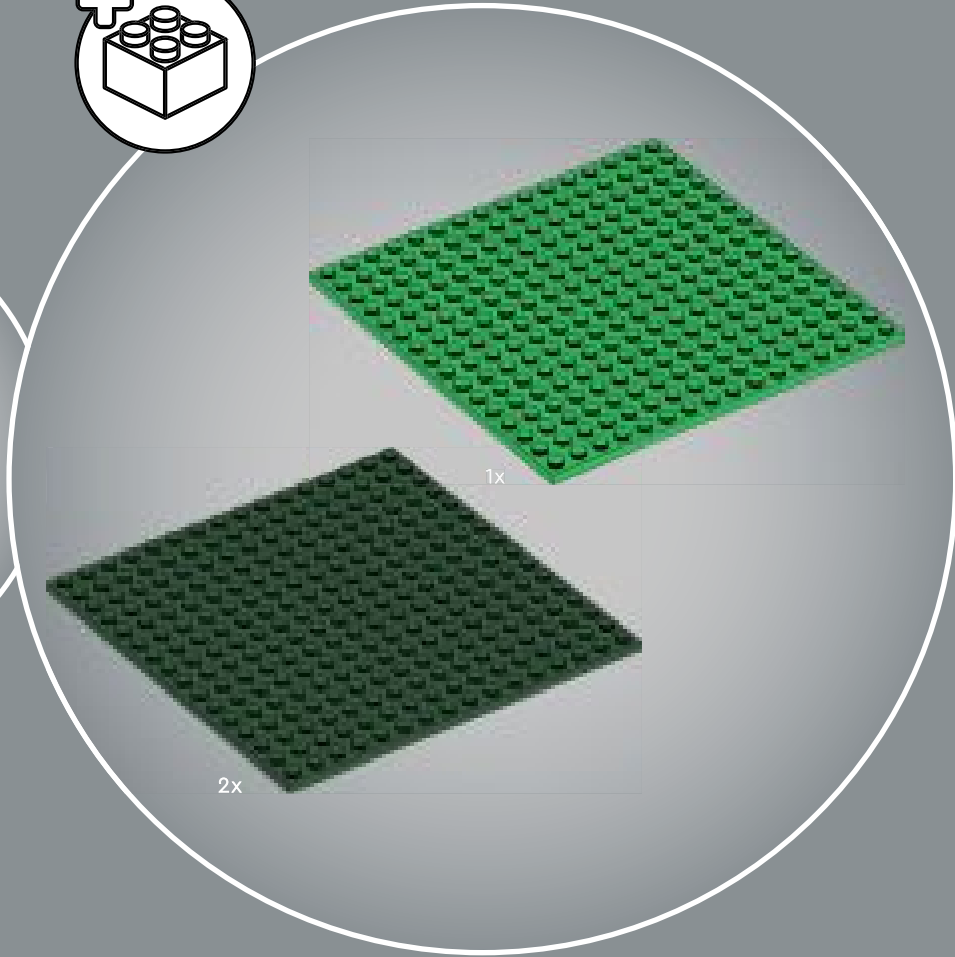
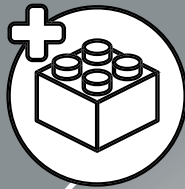

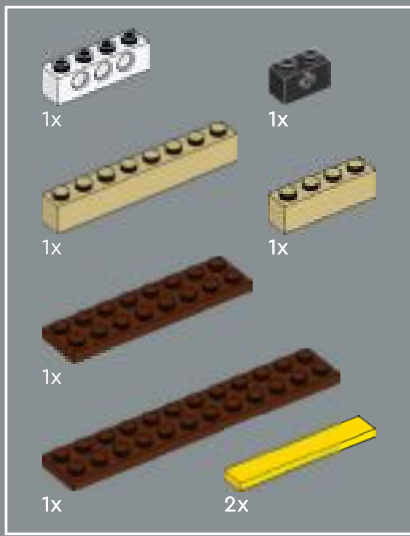

144

1

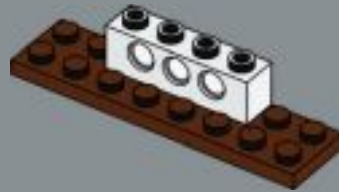

2

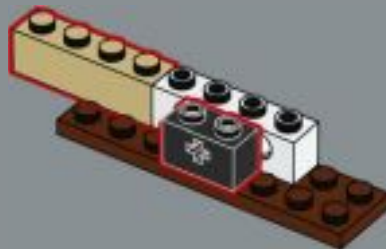

3

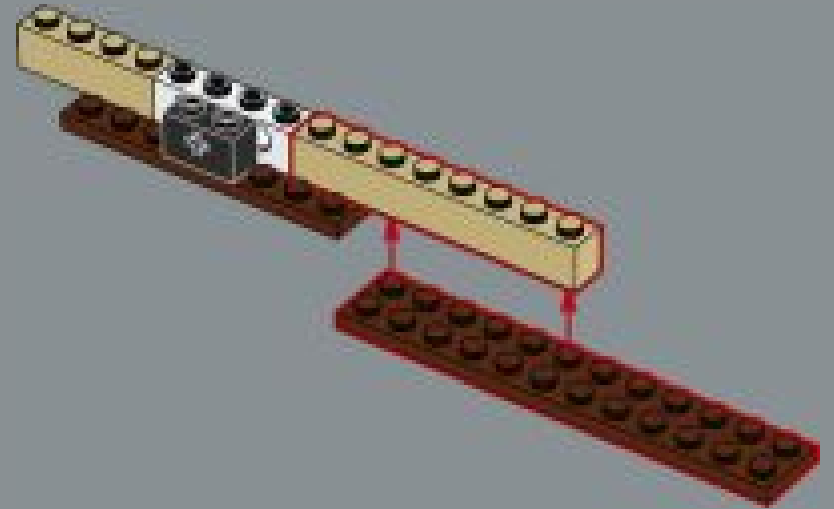

4

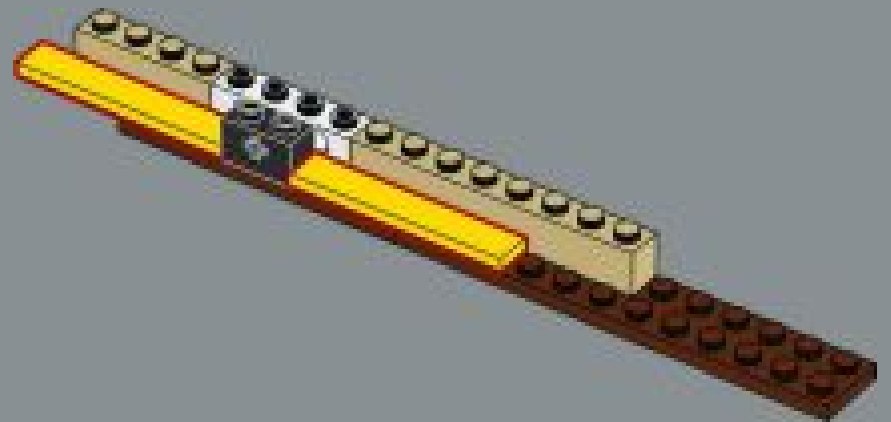



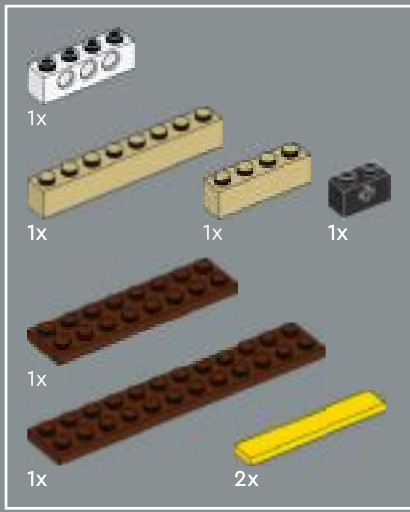

145

1



2

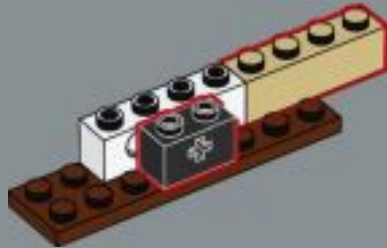

3

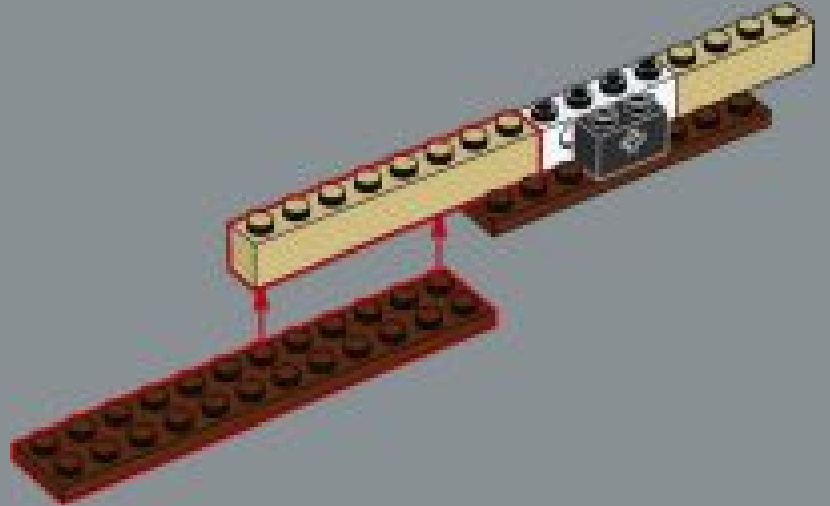

4

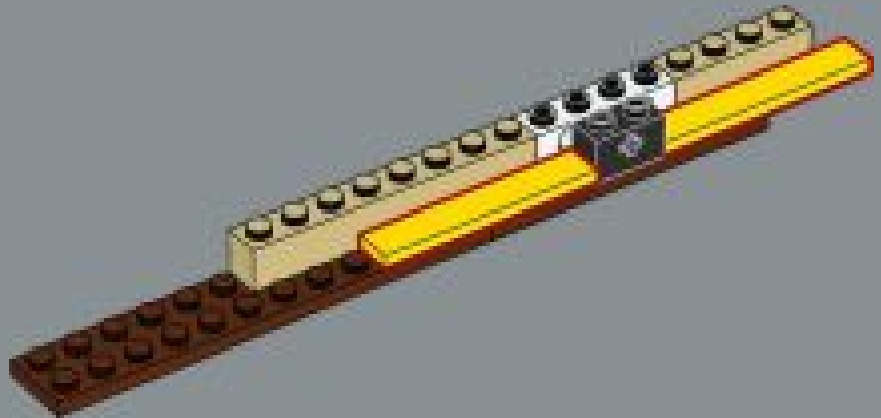

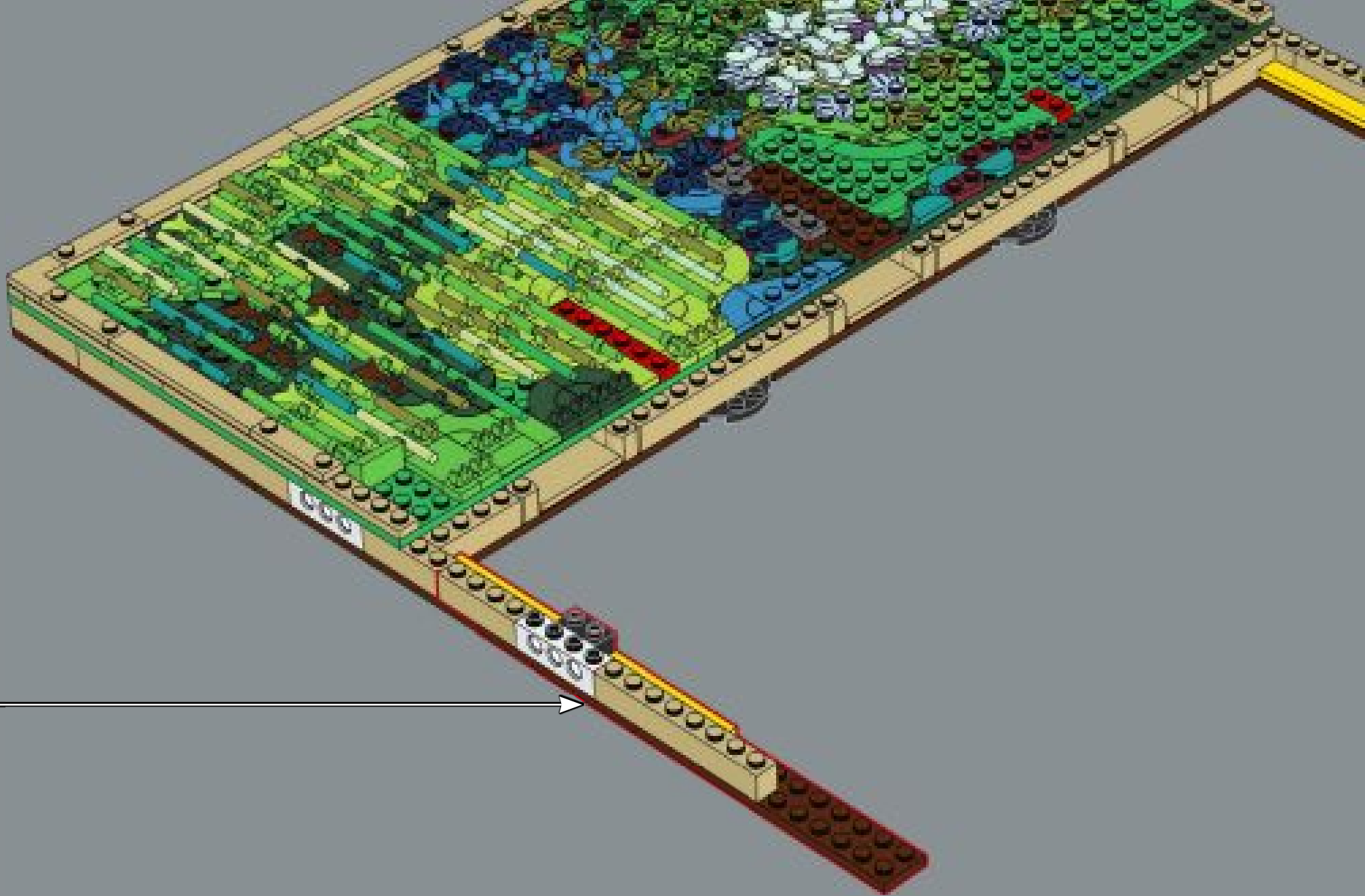

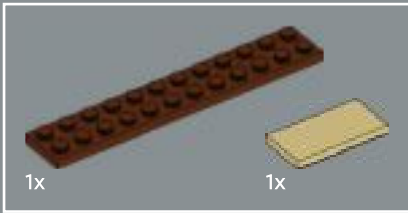

146



147

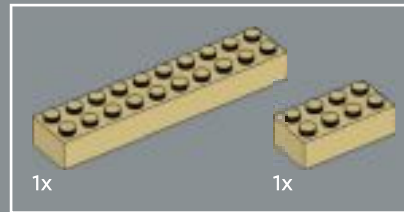
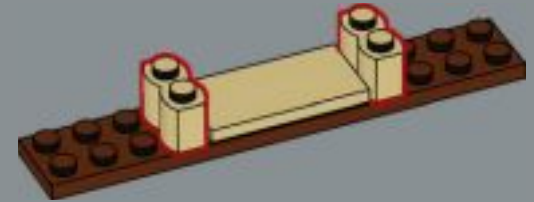

148

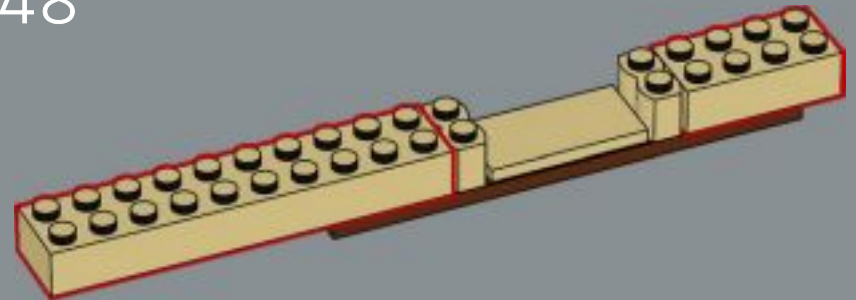

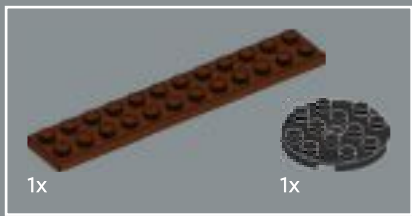

149

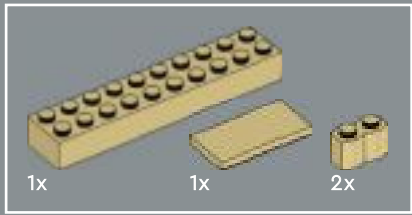
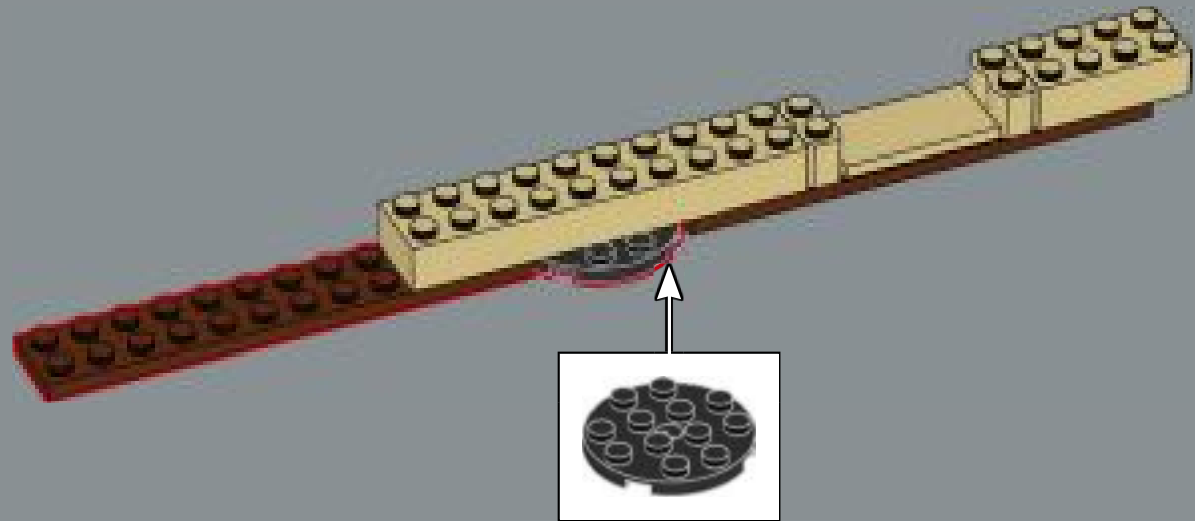

150

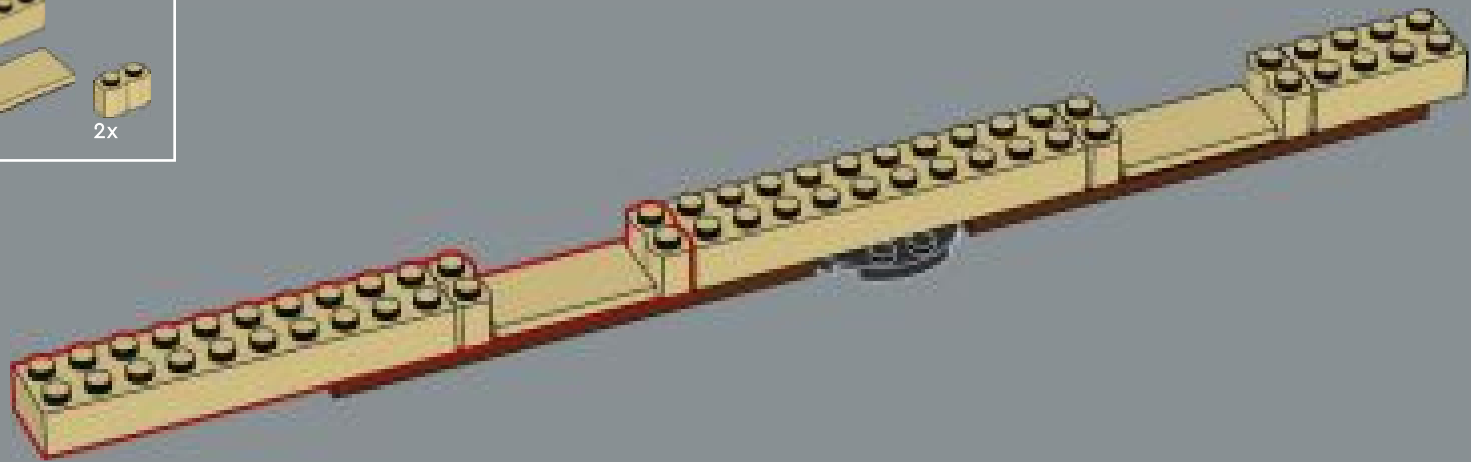

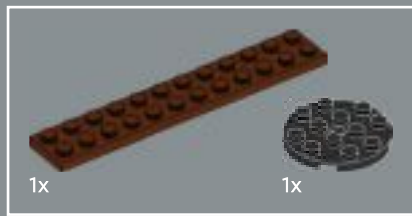

151

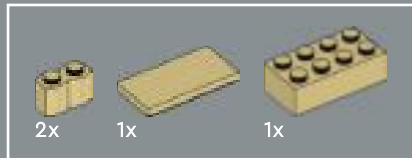
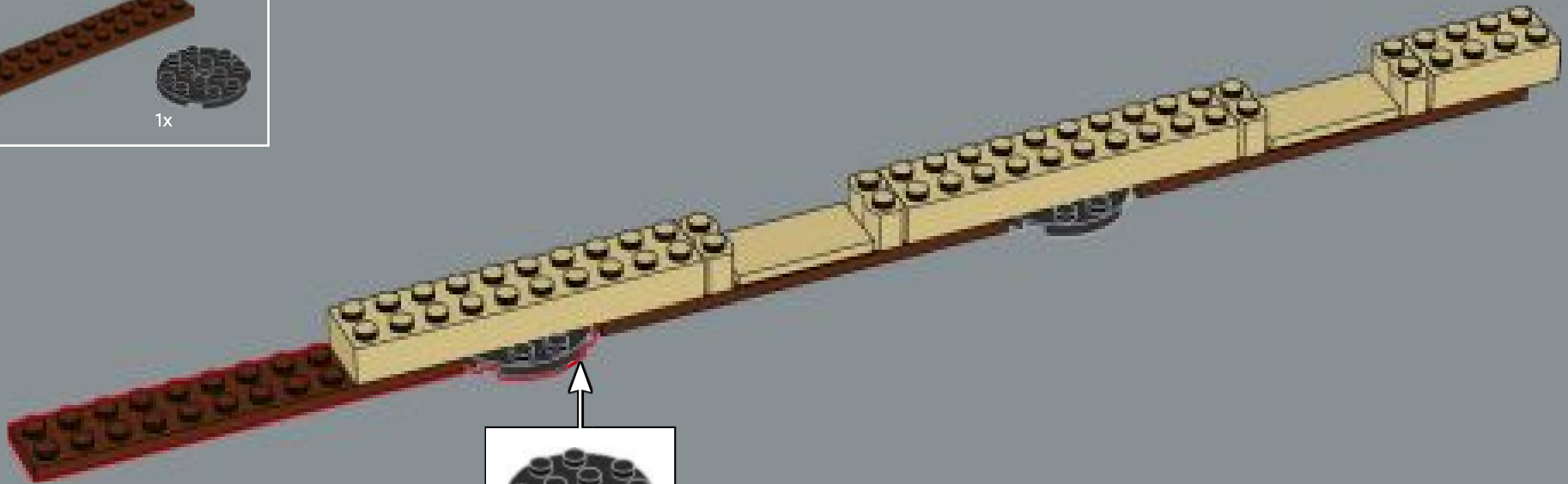

152

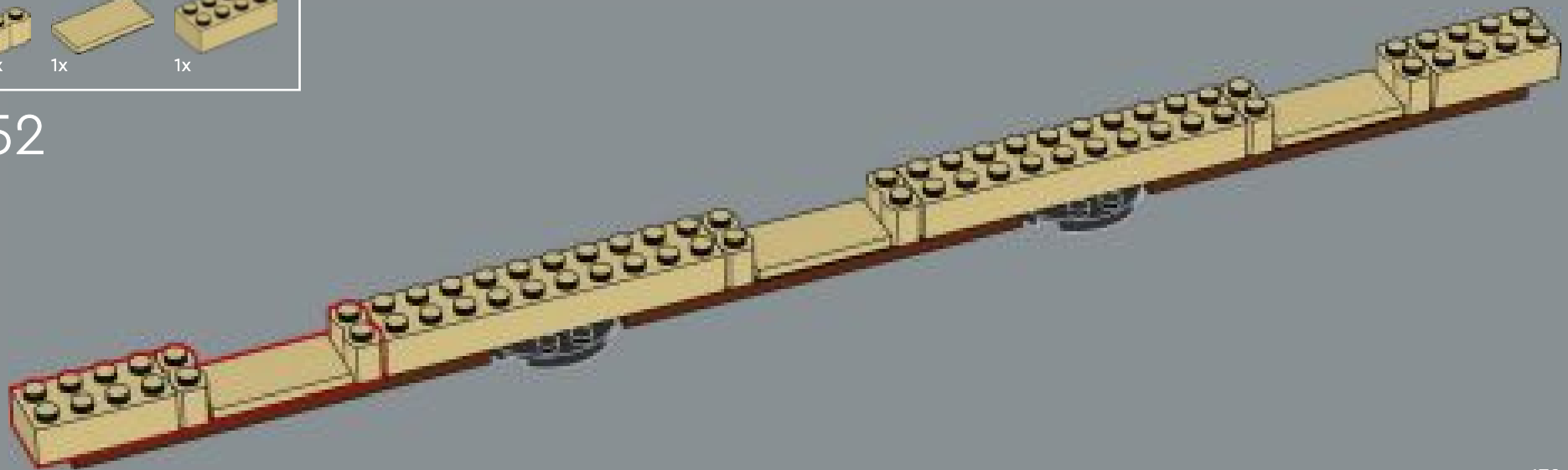



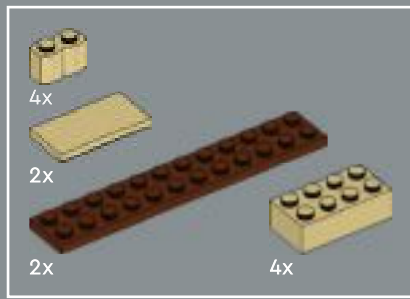

154



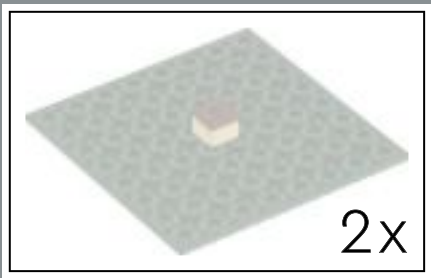

155

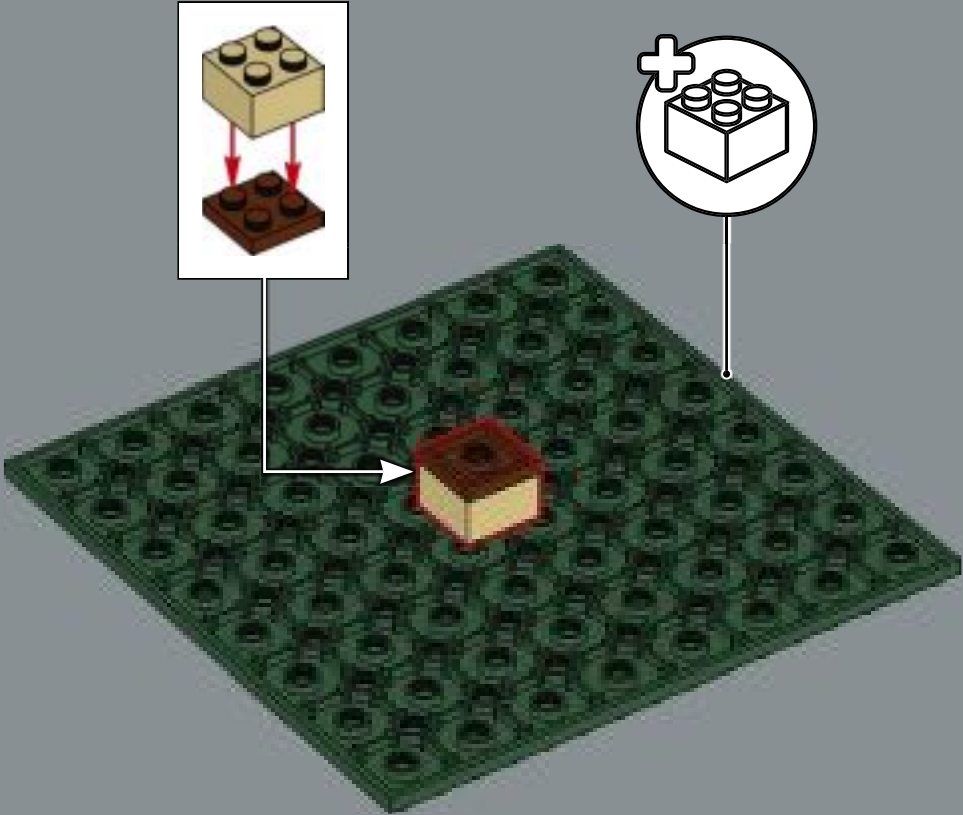





156

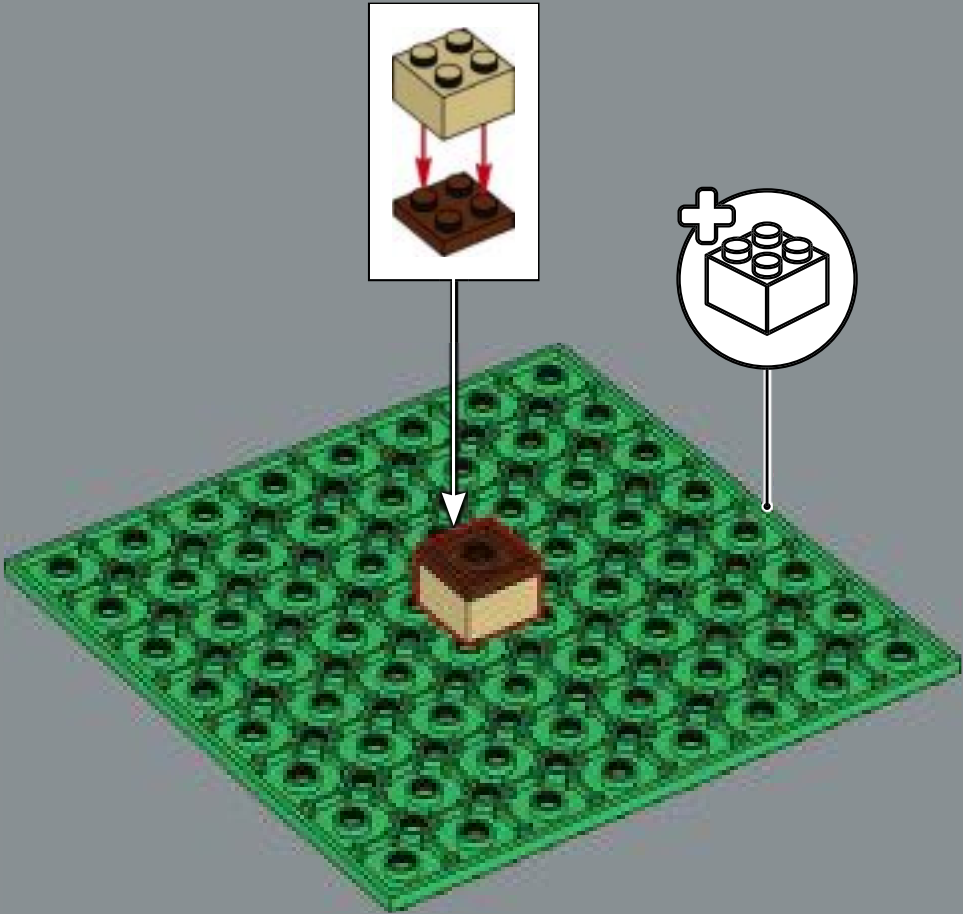

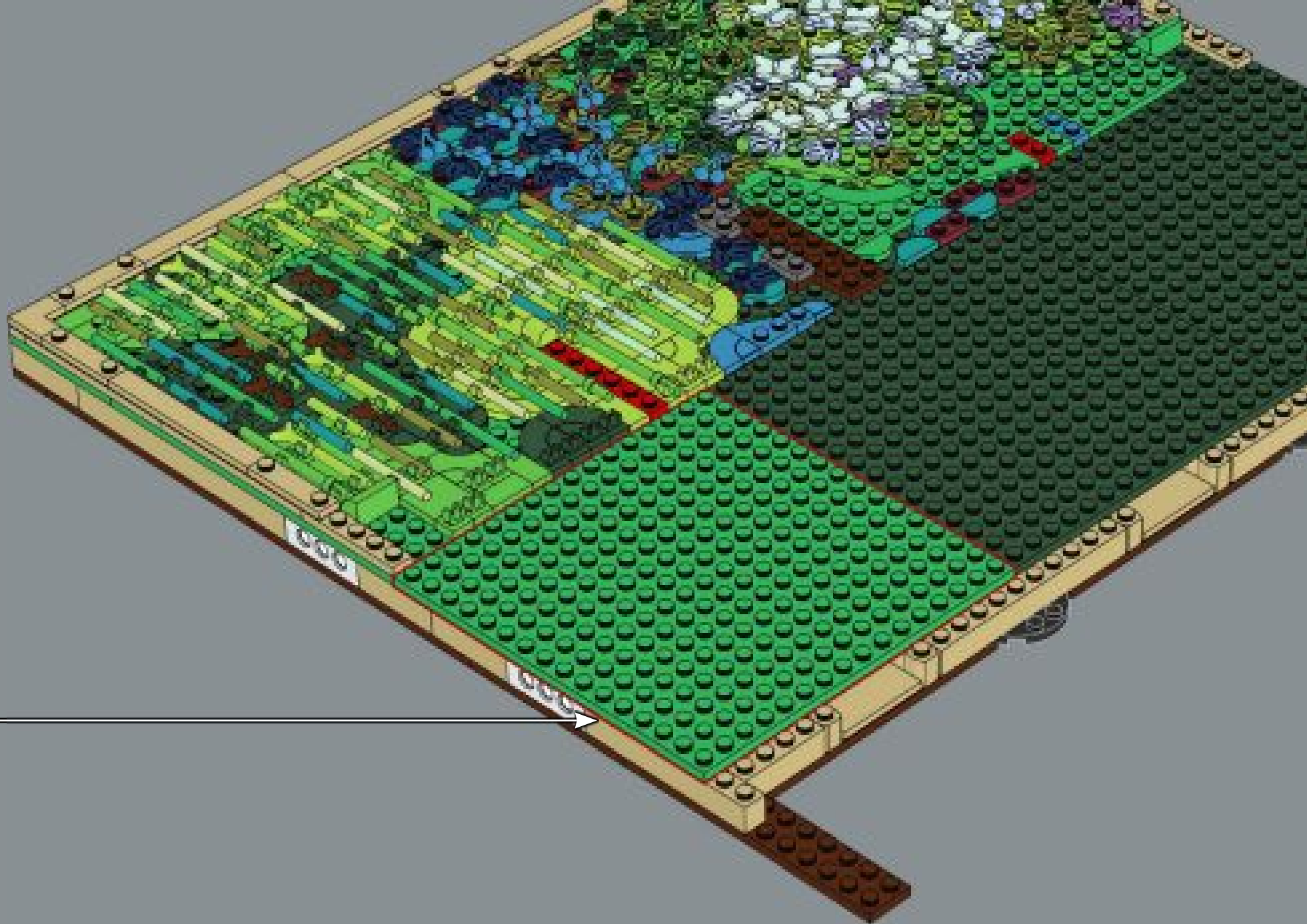

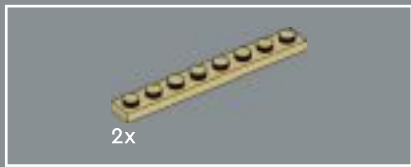

157

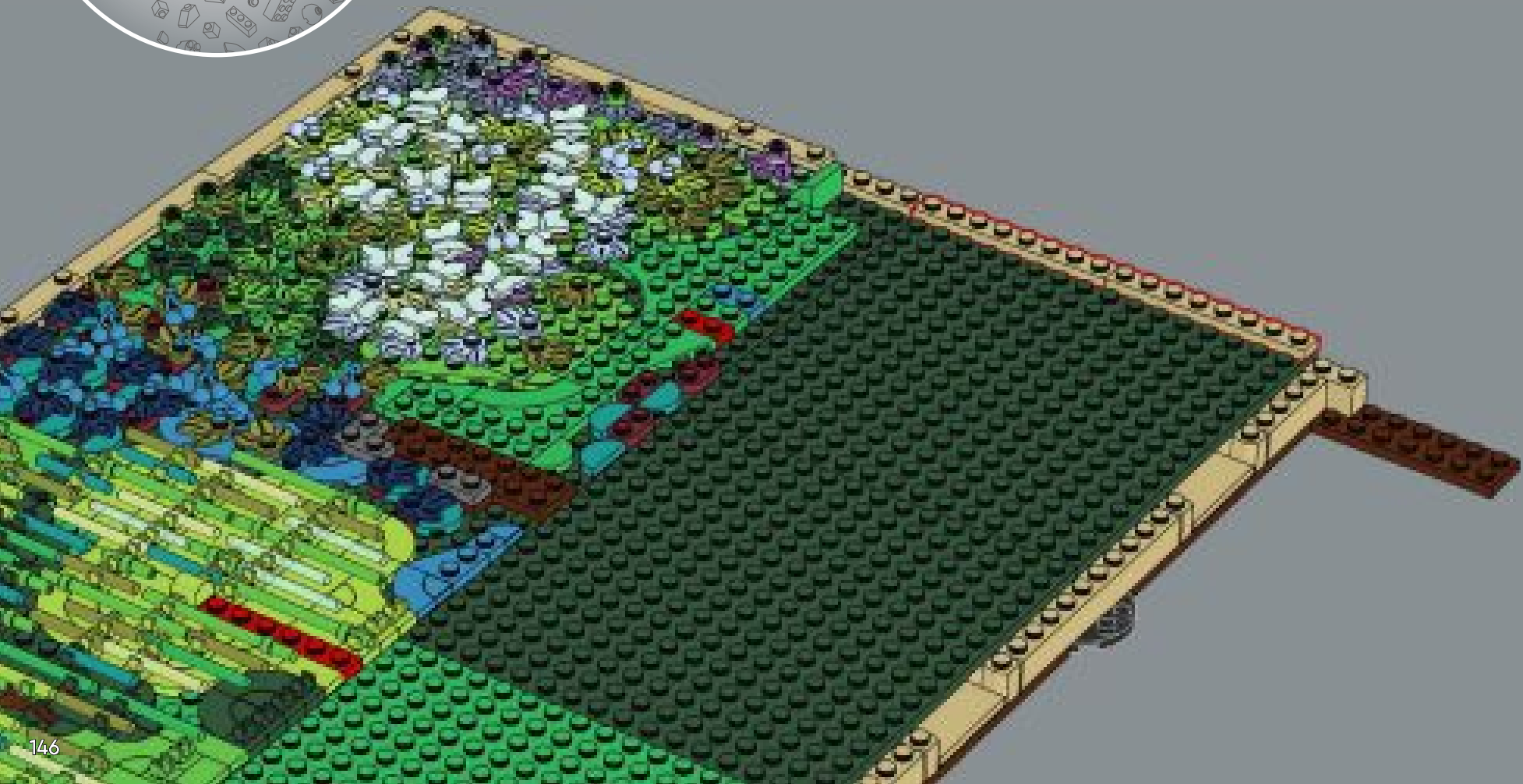



158

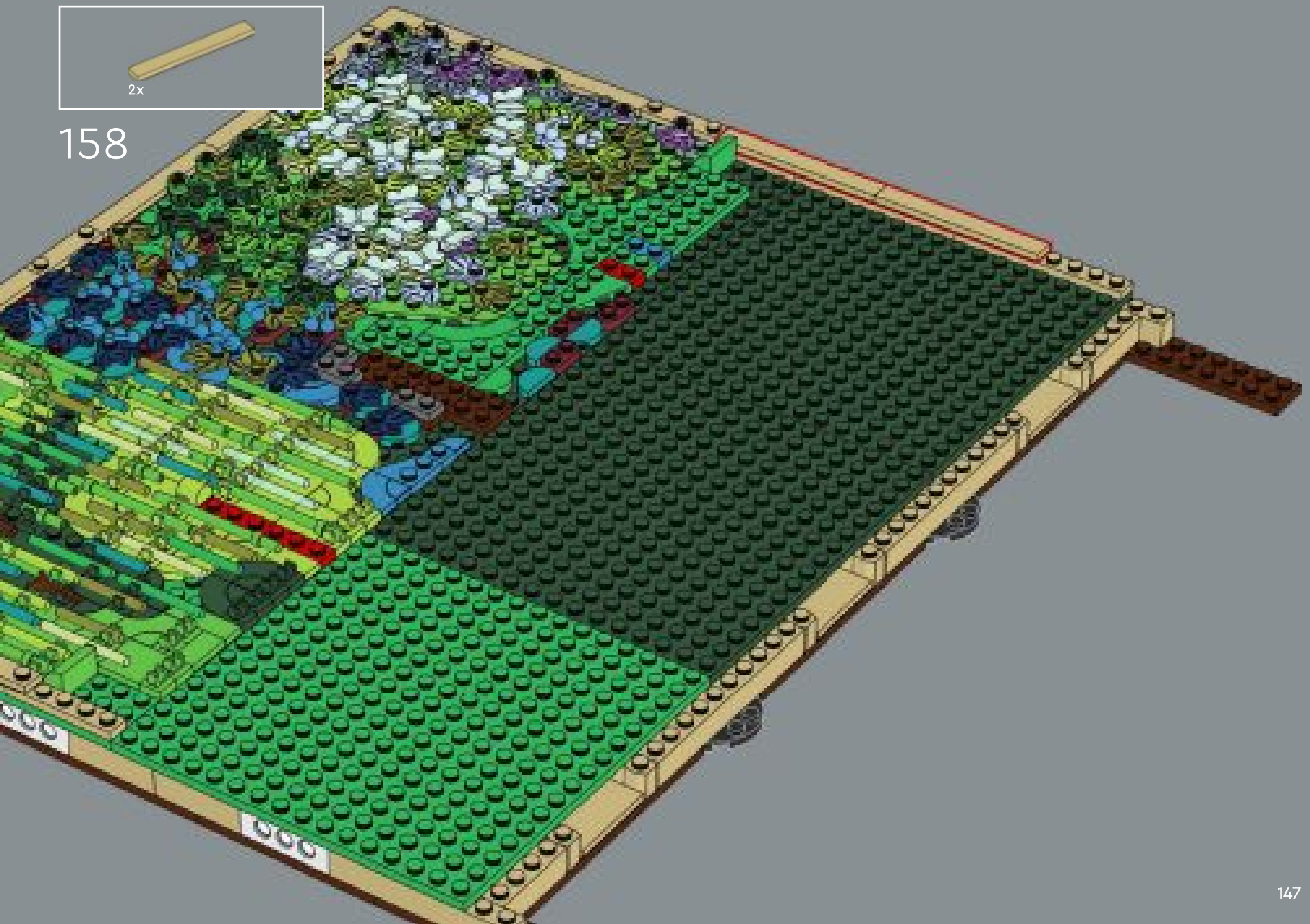

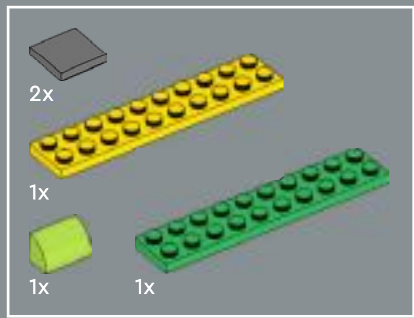

159

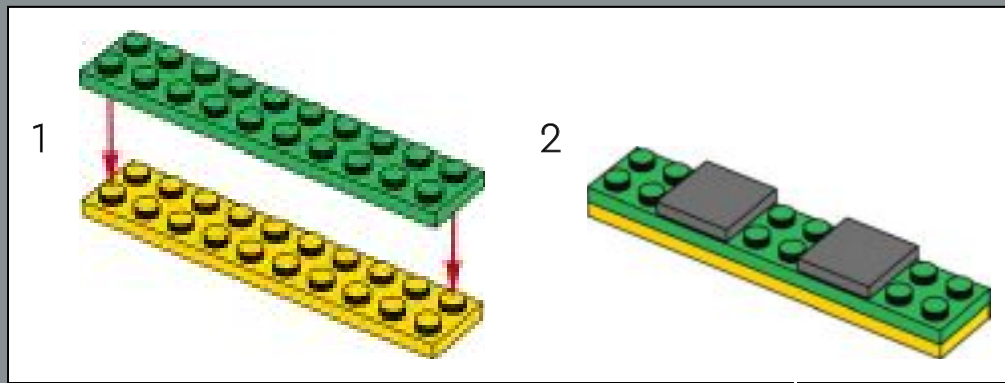



160

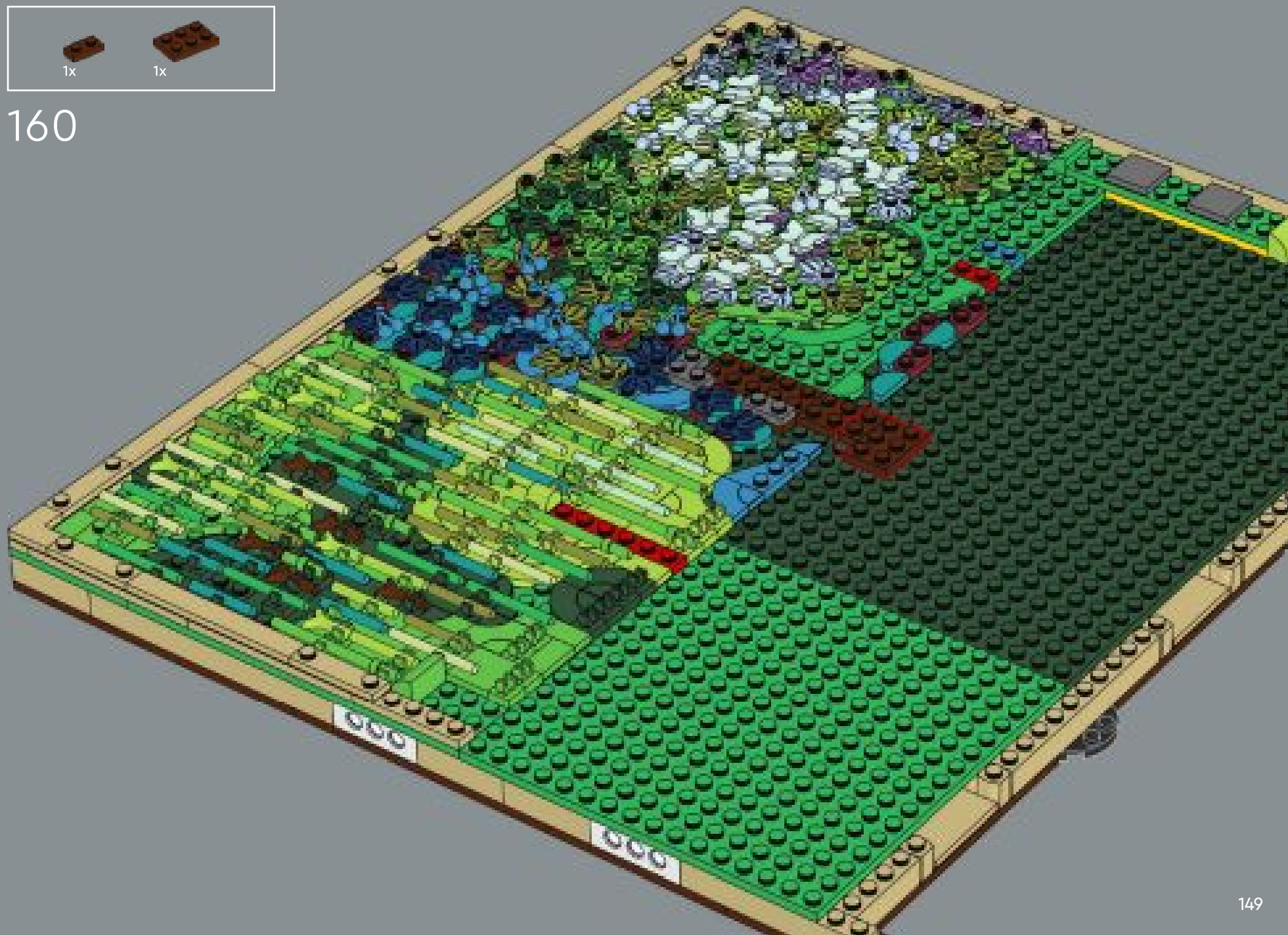

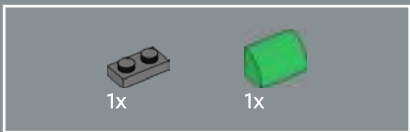

161

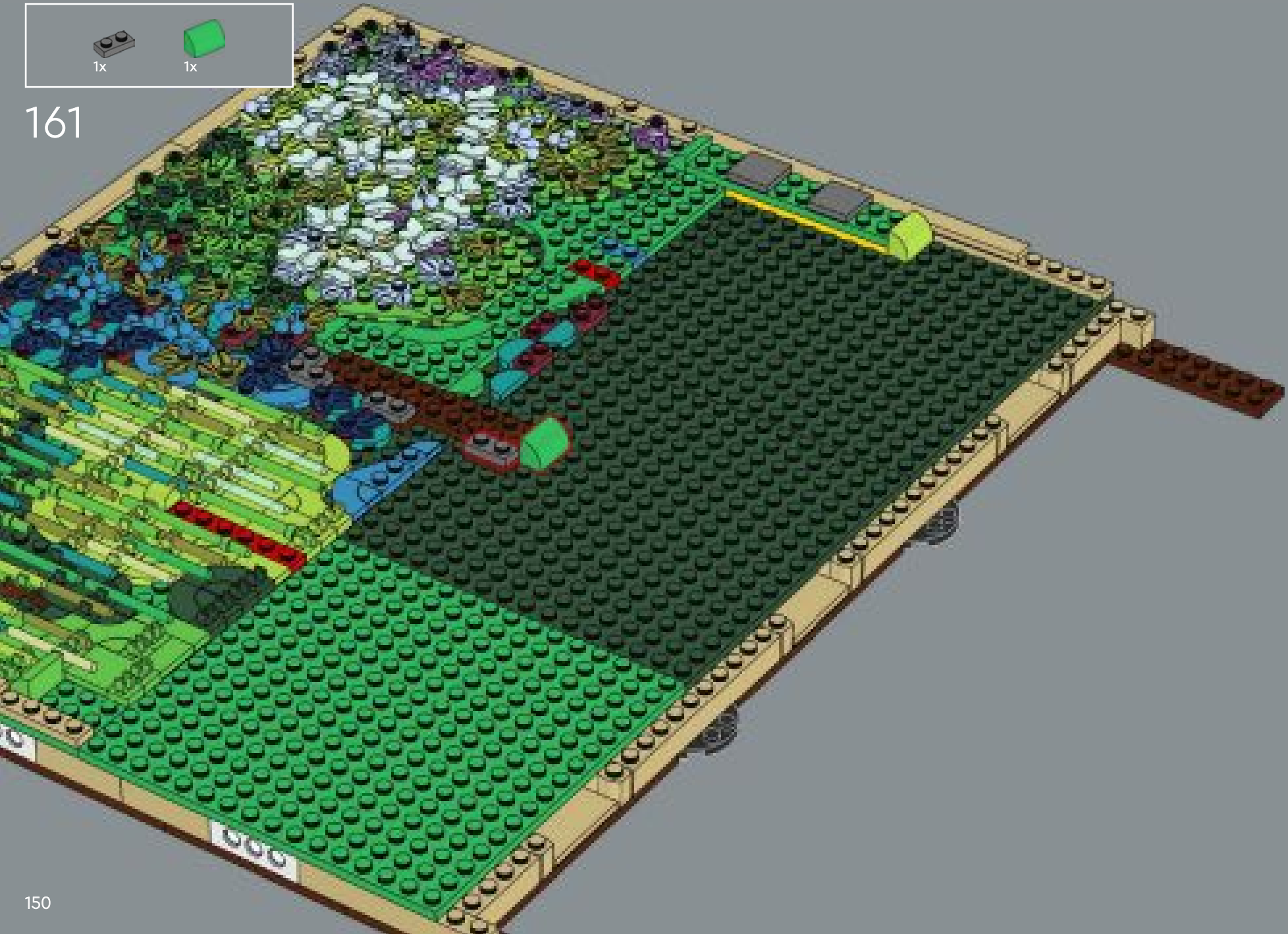

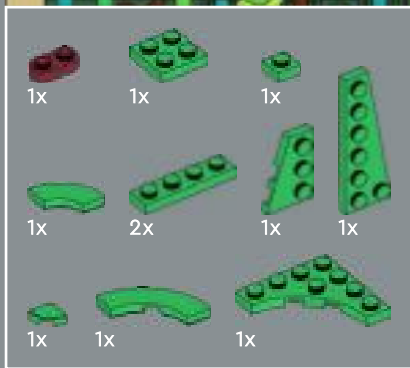

162

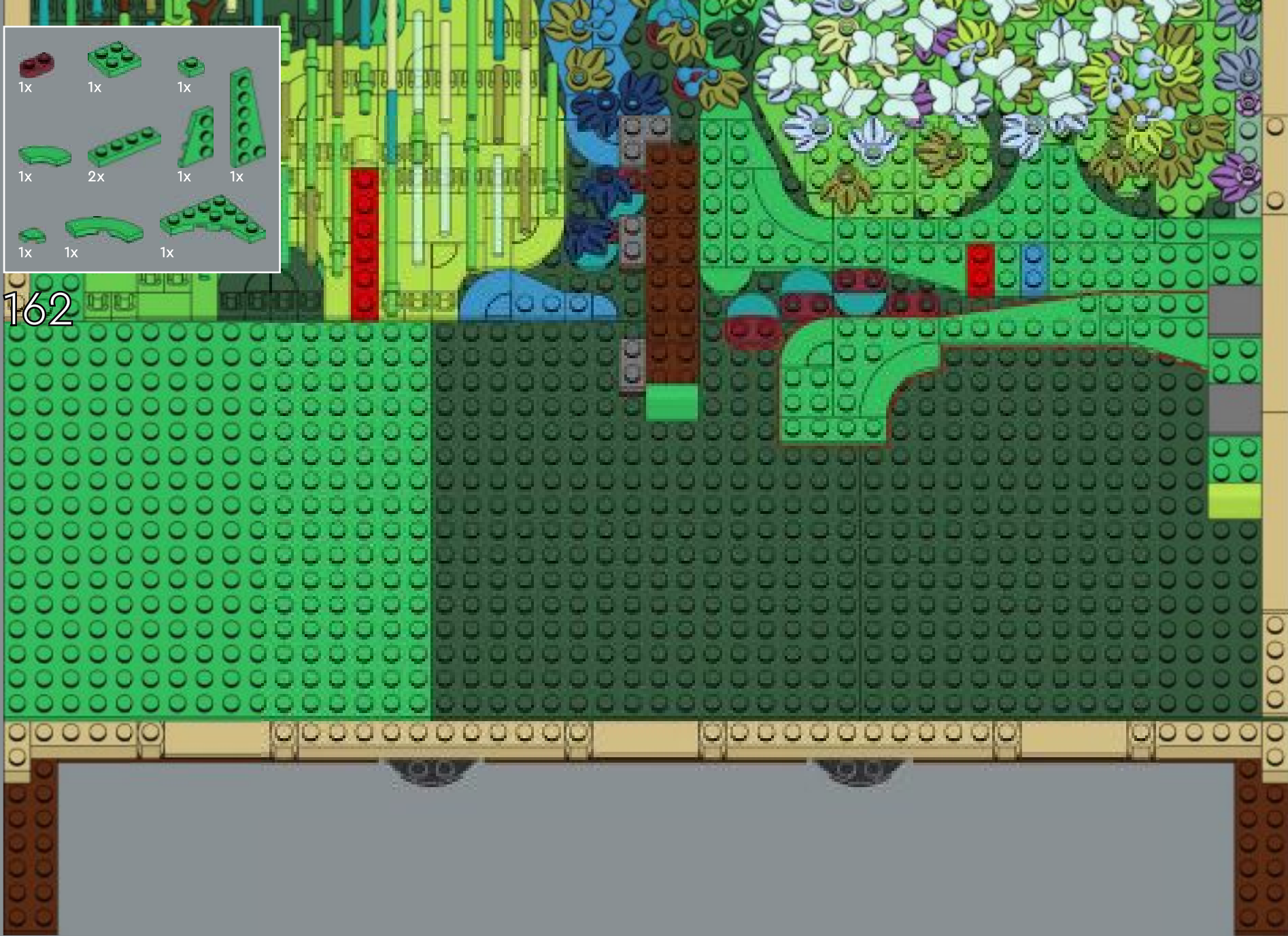

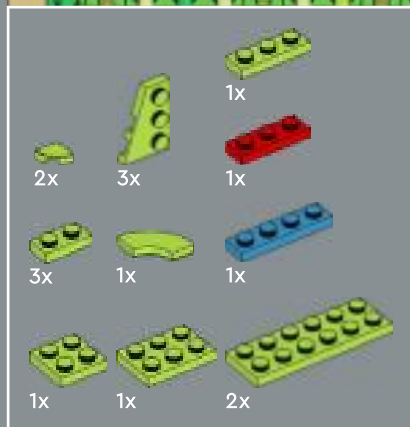

163



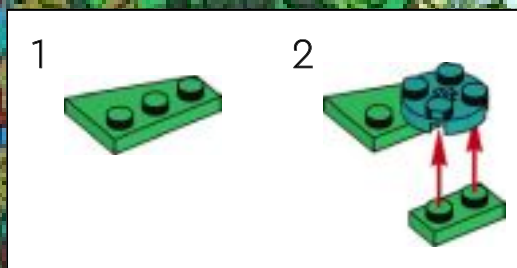
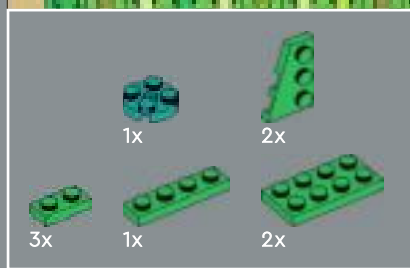

164



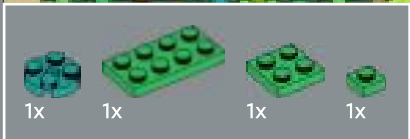

165

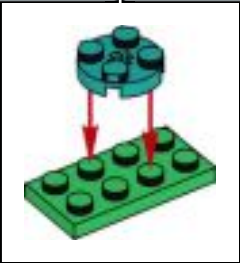



166

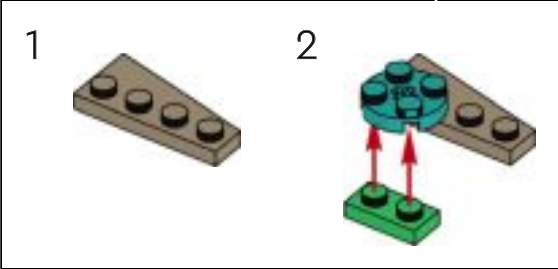

167

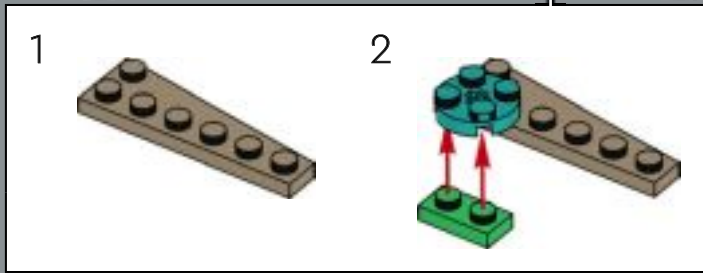
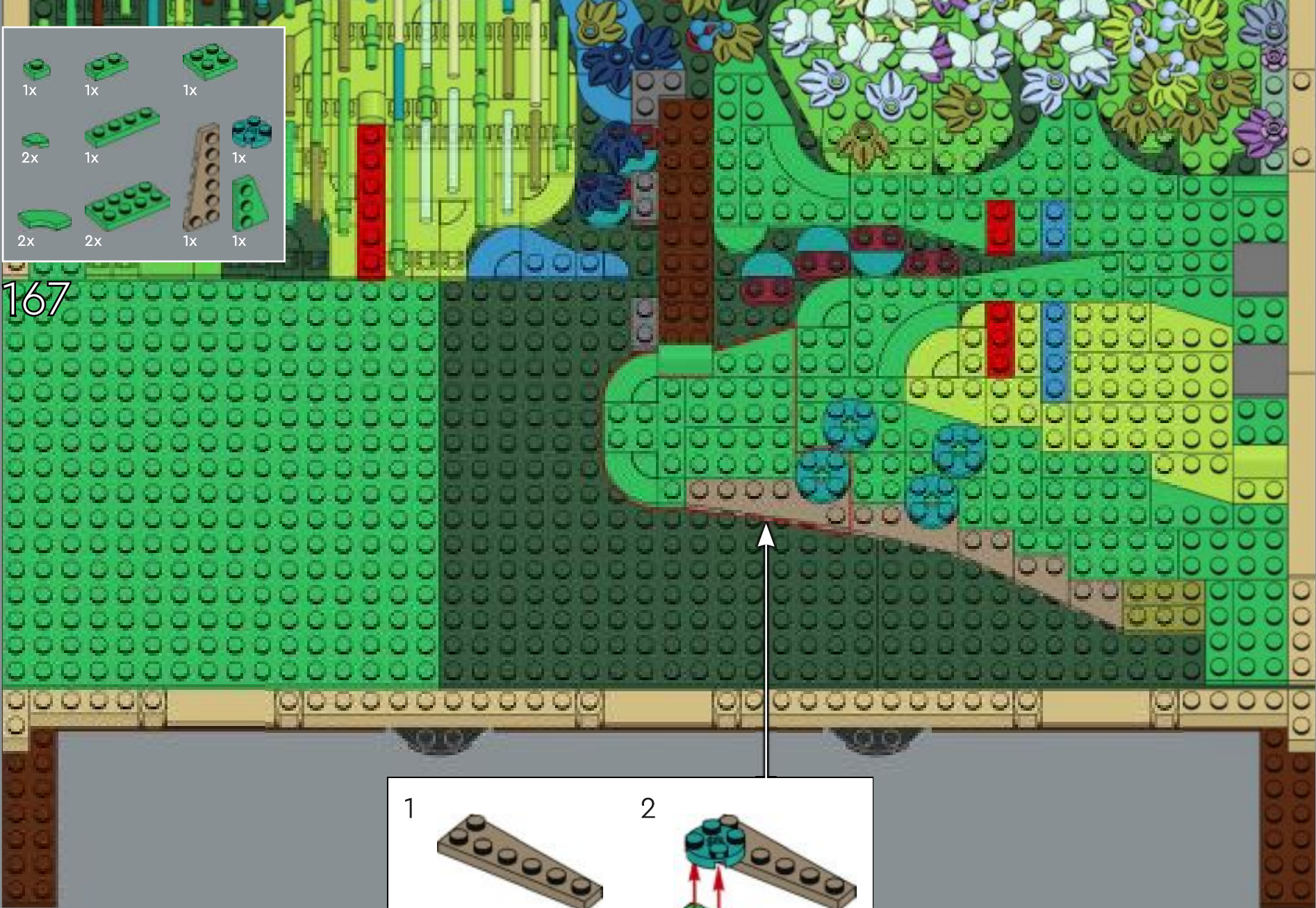
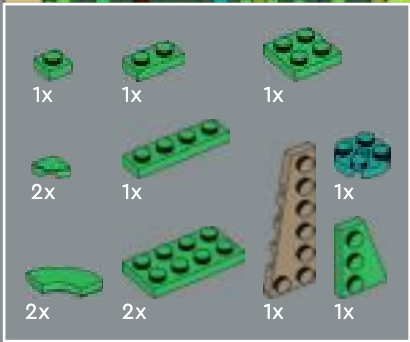



168



			
1x	3x	1x	2x
			
2x	3x	1x	1x
			
1x	1x	1x	

169





170



To create the small vertical brushstrokes that represent the reflection of the trees in the water, we used LEGO® roof tiles with lattice.

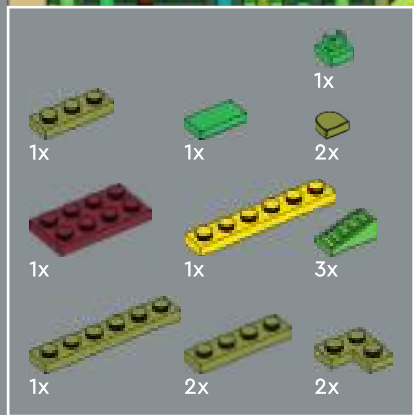

171



3x

2x

172



2x

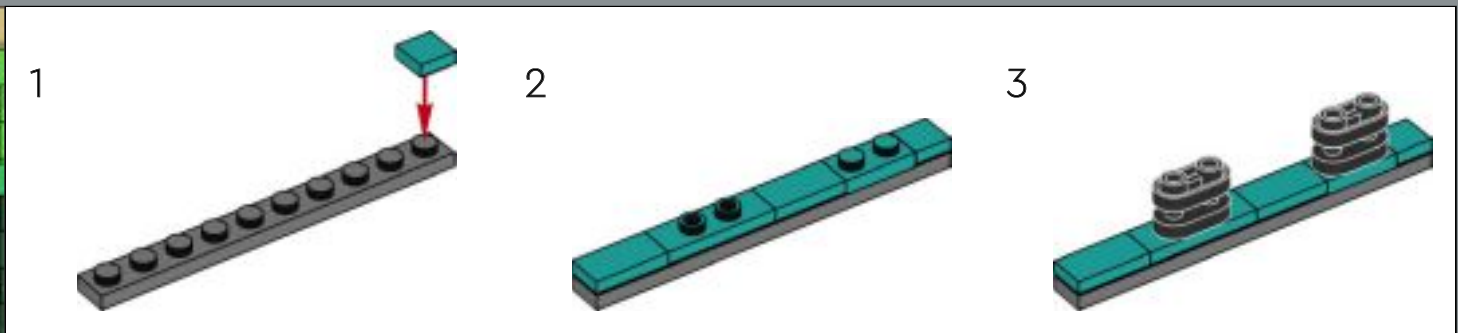
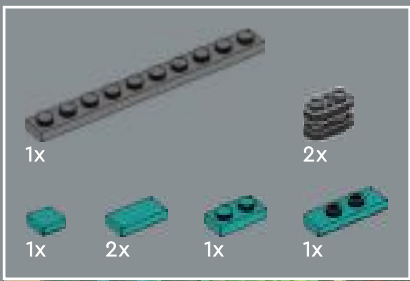

3x



173



162

1x  2x  3x  5x 

174





5x



2x

175



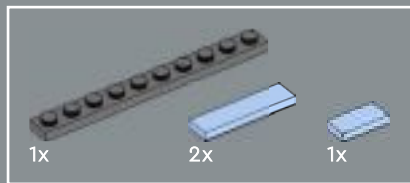

176

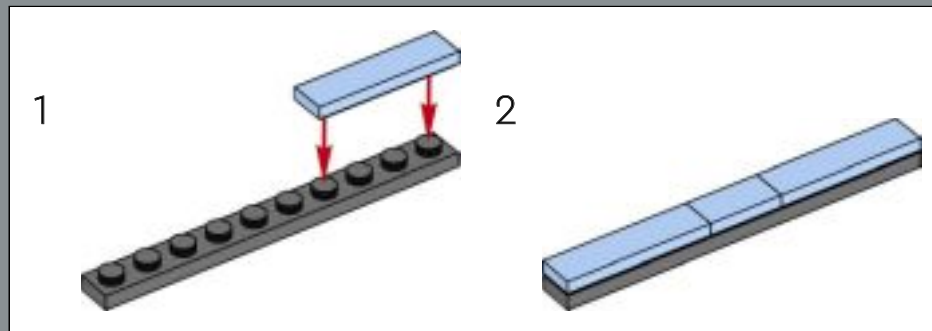

 1x
 3x
 7x
 5x

177





4x



3x

178



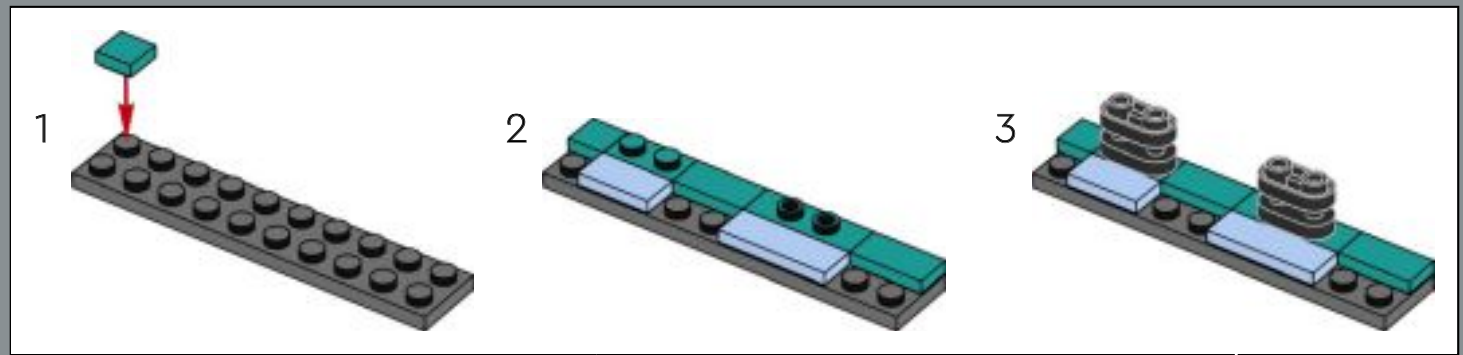
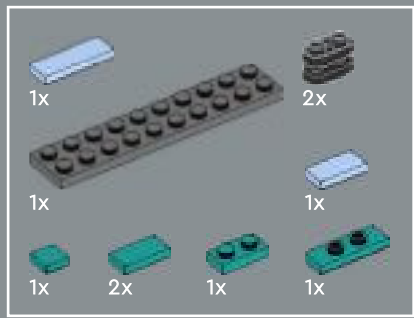

179



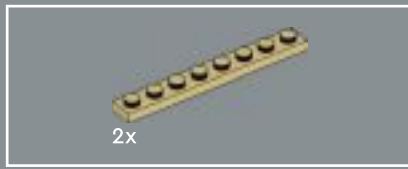

180

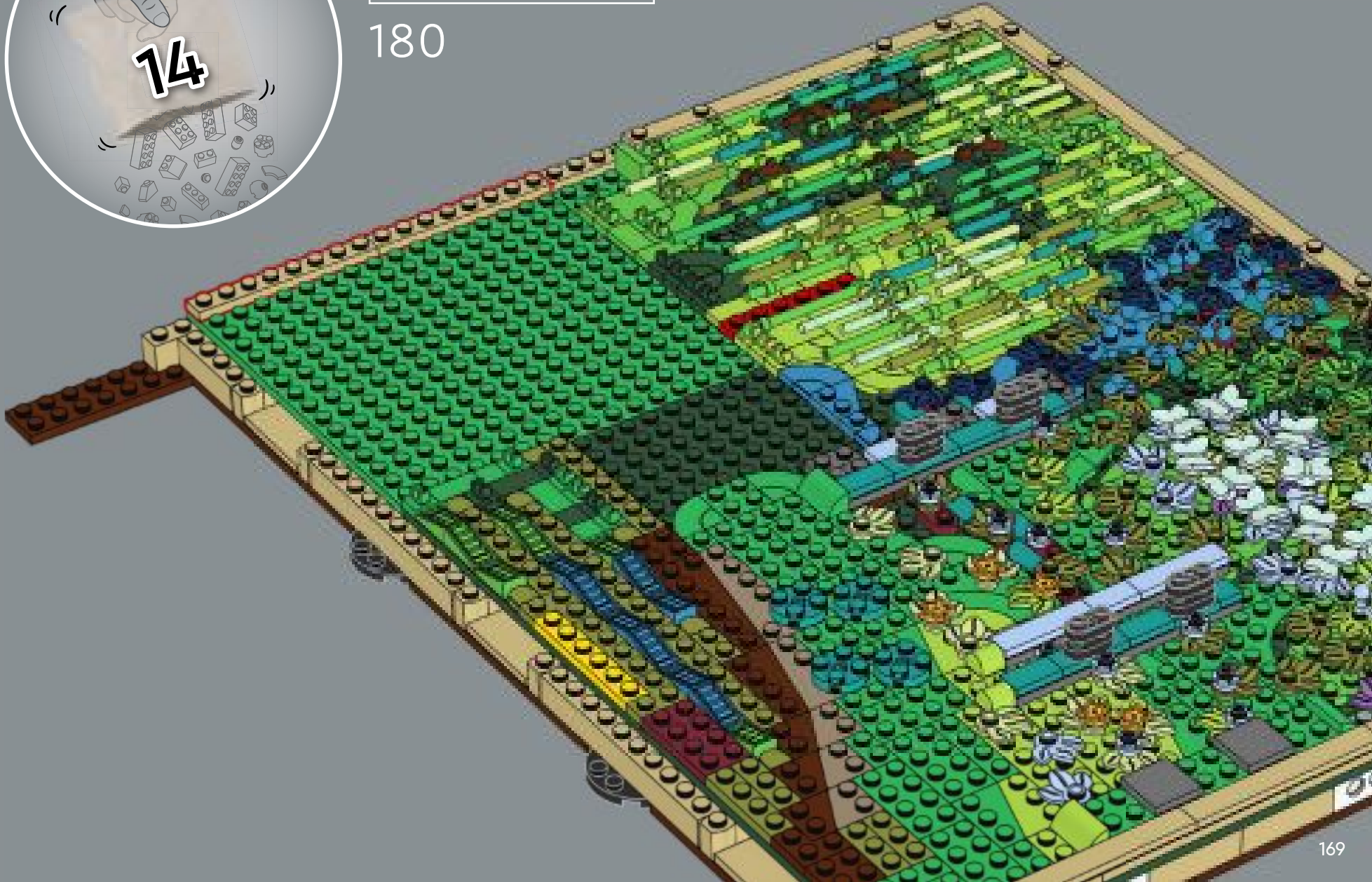

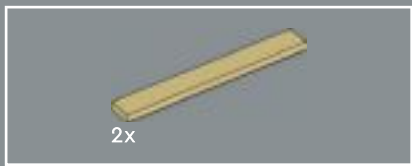

181



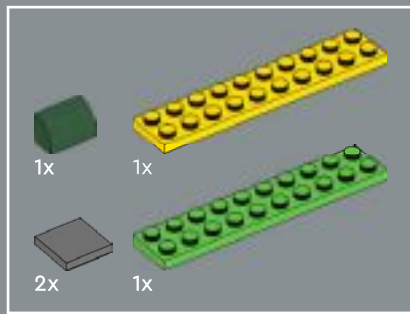

182

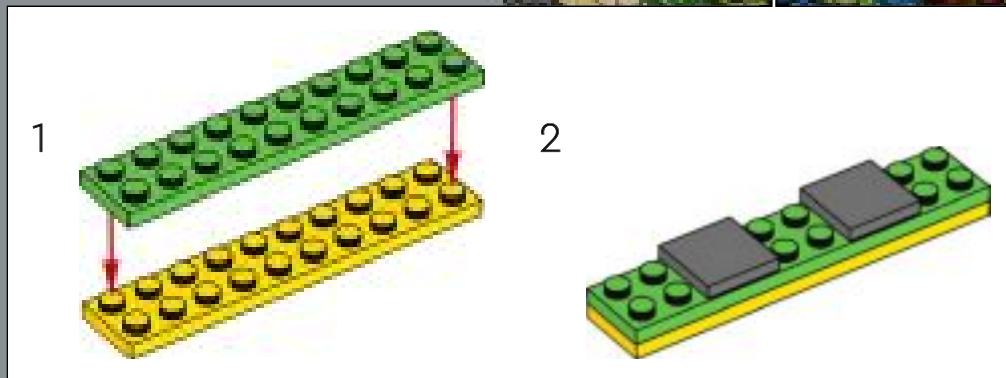
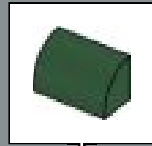

		
2x	9x	1x
		
1x	1x	2x

183





184





185



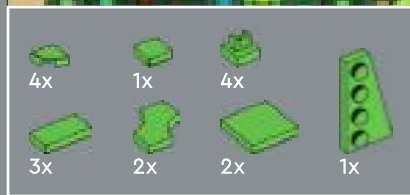

186





187





188



189

Parts list for step 189:

- 2x Blue 1x2 Technic Brick
- 3x Blue 1x3 Technic Brick
- 1x Blue 1x4 Technic Brick
- 3x Red 1x2 Technic Brick
- 4x Blue 1x2 Technic Brick with Hole
- 1x Blue 1x3 Technic Brick with Hole
- 1x Blue 1x4 Technic Brick with Hole



4x

3x

190





191





192



193





For the vegetation and the water lilies, we used a combination of different elements. A 1x1 plate with a LEGO® animal-tooth element depicts the edges of the lily pads.

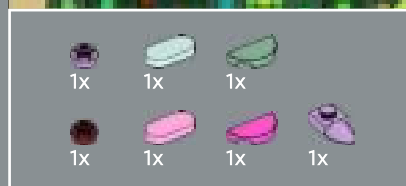





194



			
2x	1x	1x	1x
			
1x	1x	1x	1x

195



				
1x	1x	1x	2x	1x
				
1x	1x	2x	2x	1x







196





197



 1x	 2x	 2x	 1x
 1x	 3x	 6x	 1x

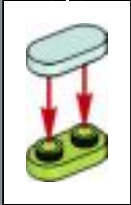

198





199



-  1x
-  1x
-  3x
-  2x





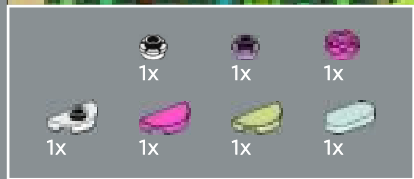

200





201



 1x	 4x	 1x	 1x
 1x	 2x	 1x	 2x

202





203



LEGO® minifigure paintbrushes emphasise the smaller vertical brushstrokes.



204

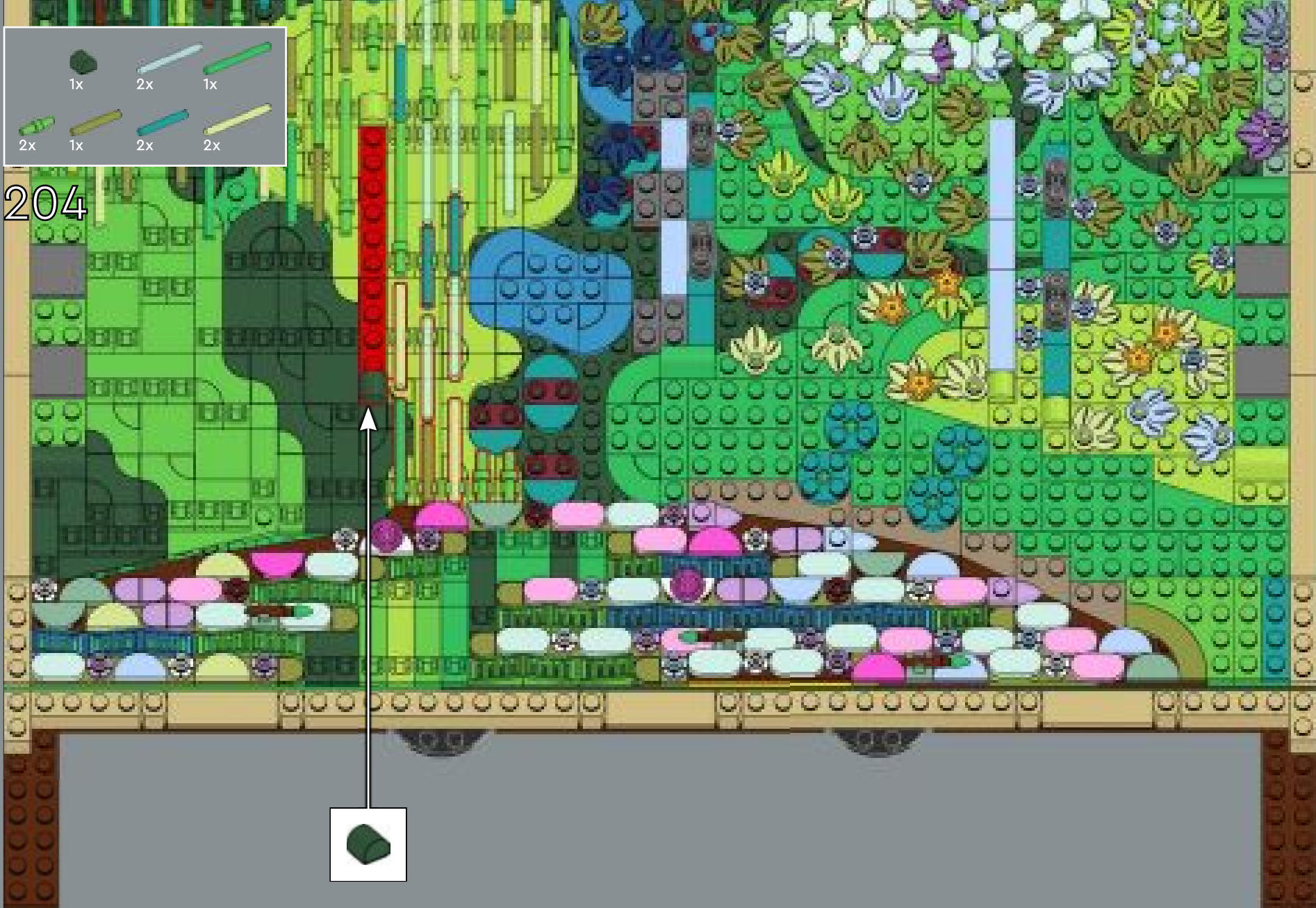

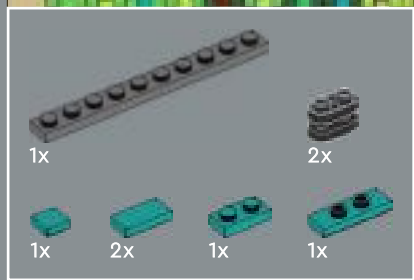

205

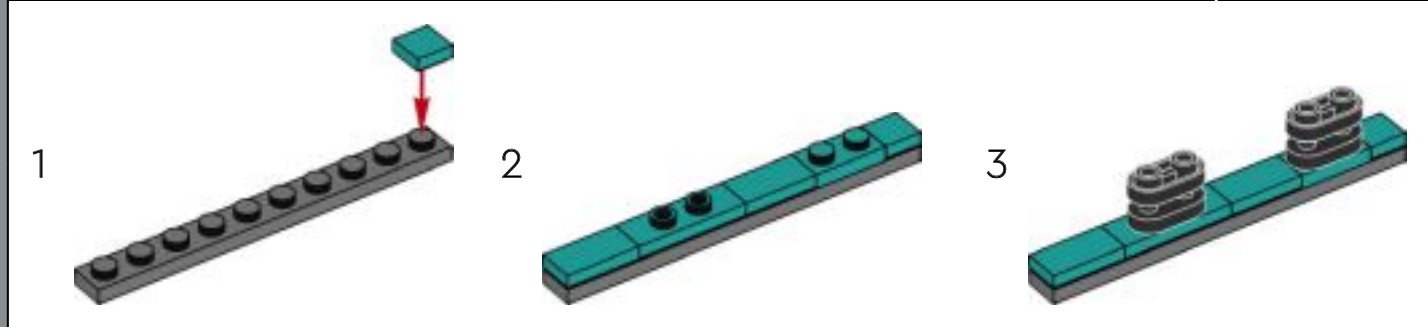



206



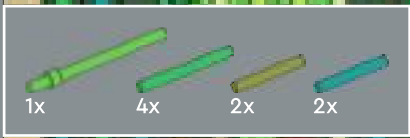

207

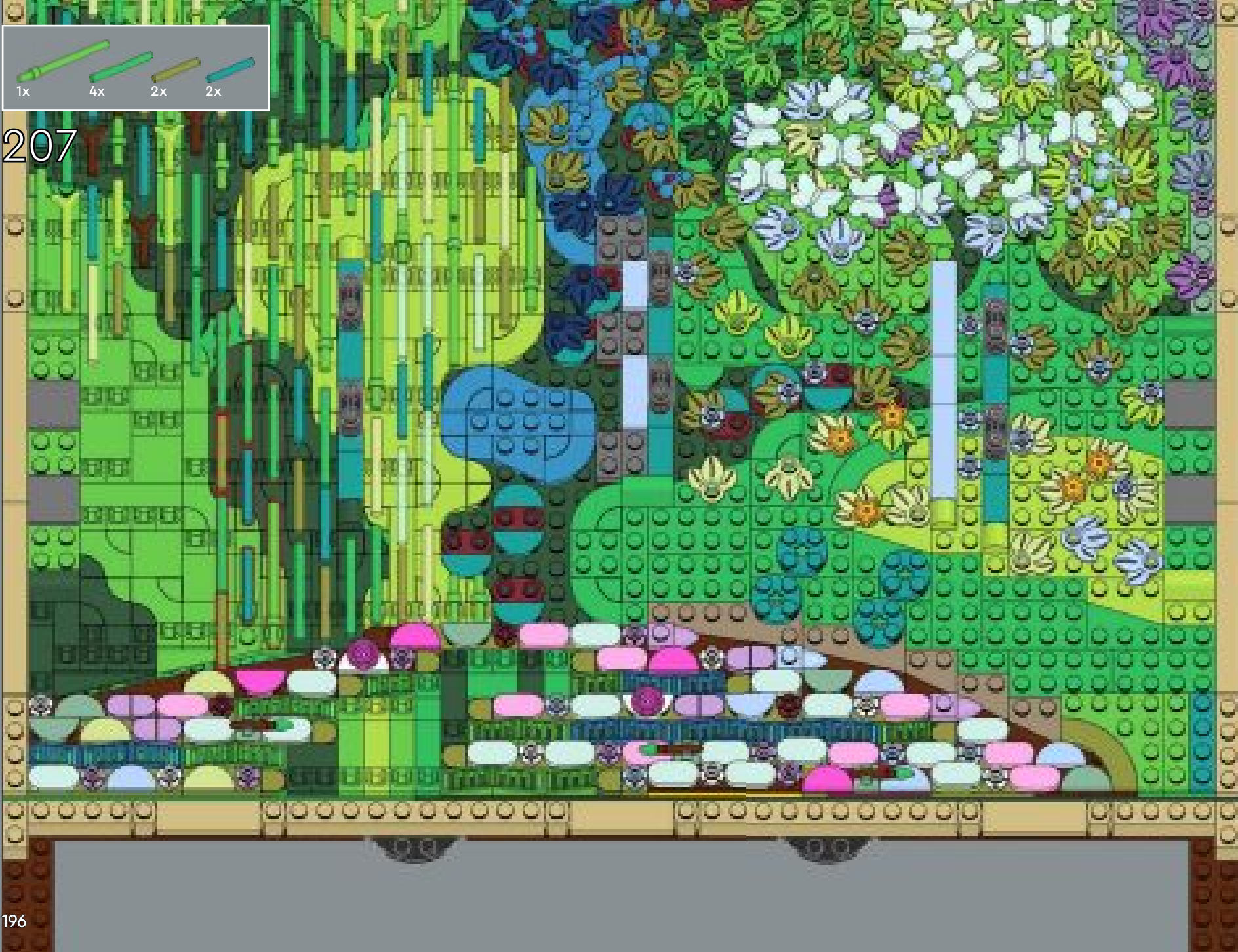



208

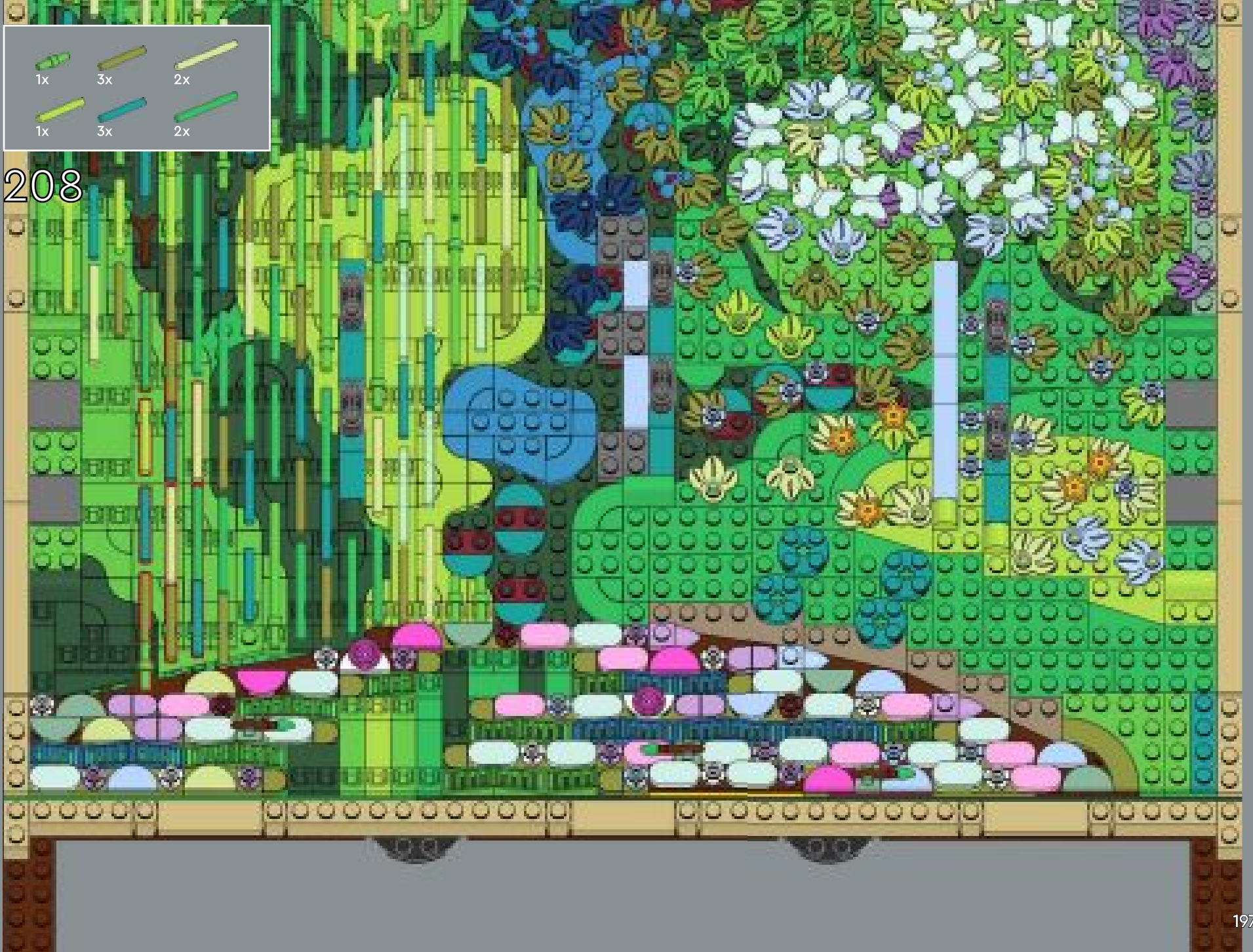

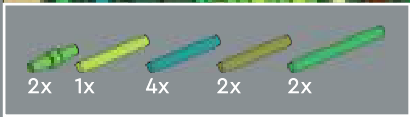

209



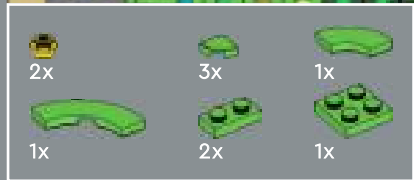
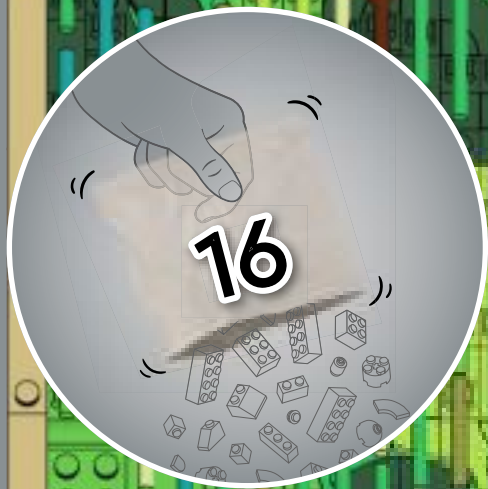

210

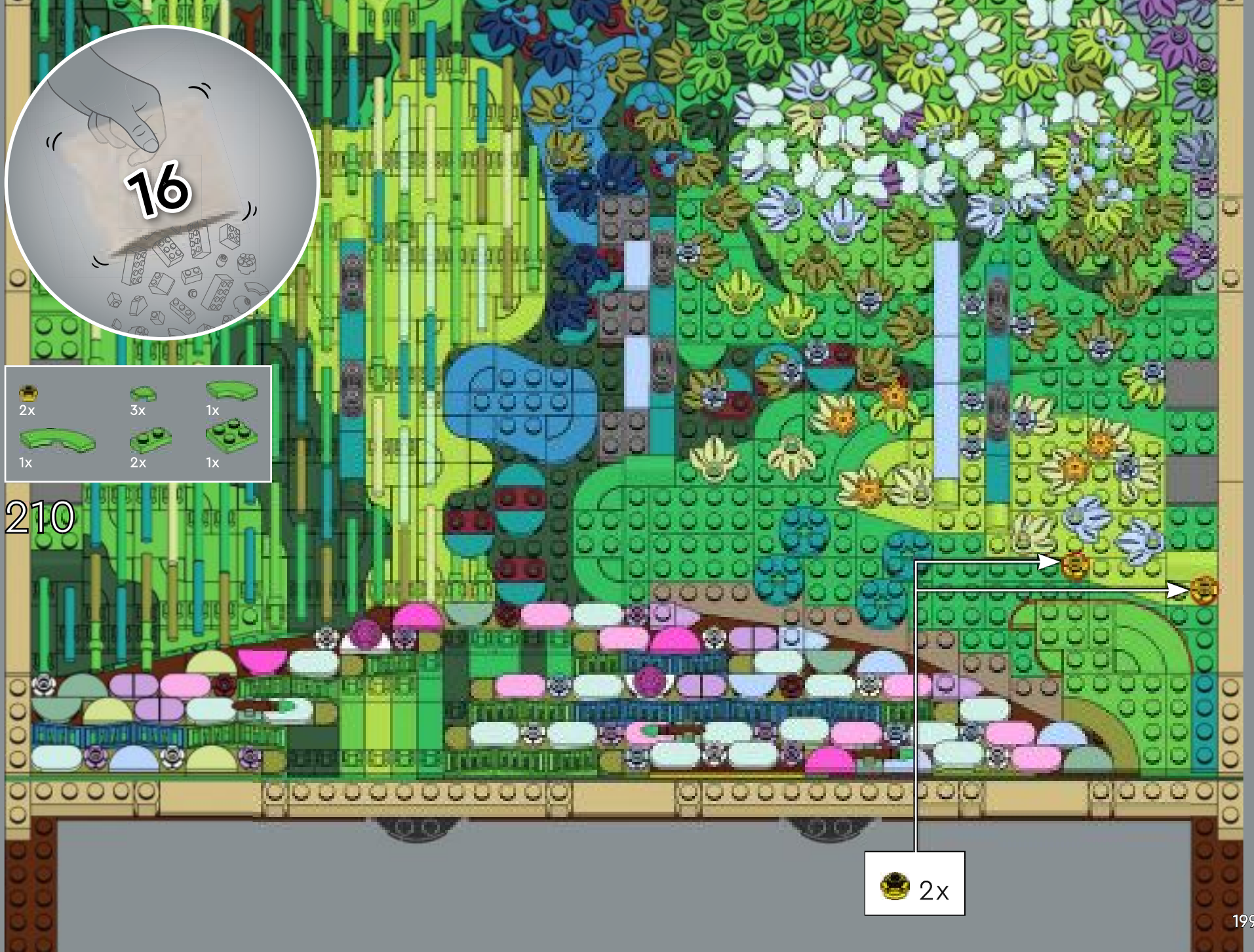



3x



3x



3x

211

1





2



3x



		
1x	2x	3x



212

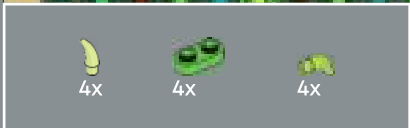

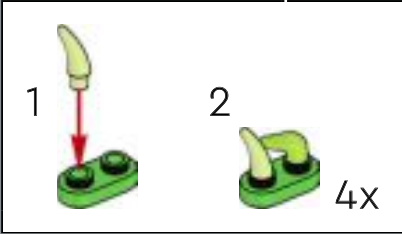

213



 2x
 2x
 2x

214



 2x

 2x

			
4x	2x	4x	2x

215



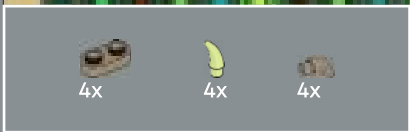

216

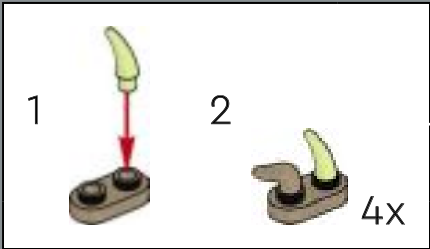

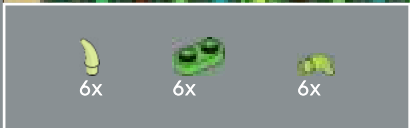

217





2x



2x

218



2x

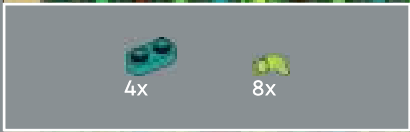

219

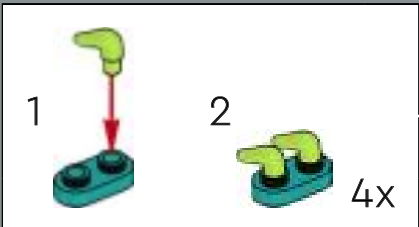



220



1x 5x 5x 4x

221



1 2

1 2 4x





4x



222



Different types of elements are used to depict the directionality of the vegetation under the bridge—see if you can spot bananas, different horns from LEGO® cows, dinosaurs and even Viking helmets!

 2x
  2x
  2x

223

 2x



3x 3x

224



3x

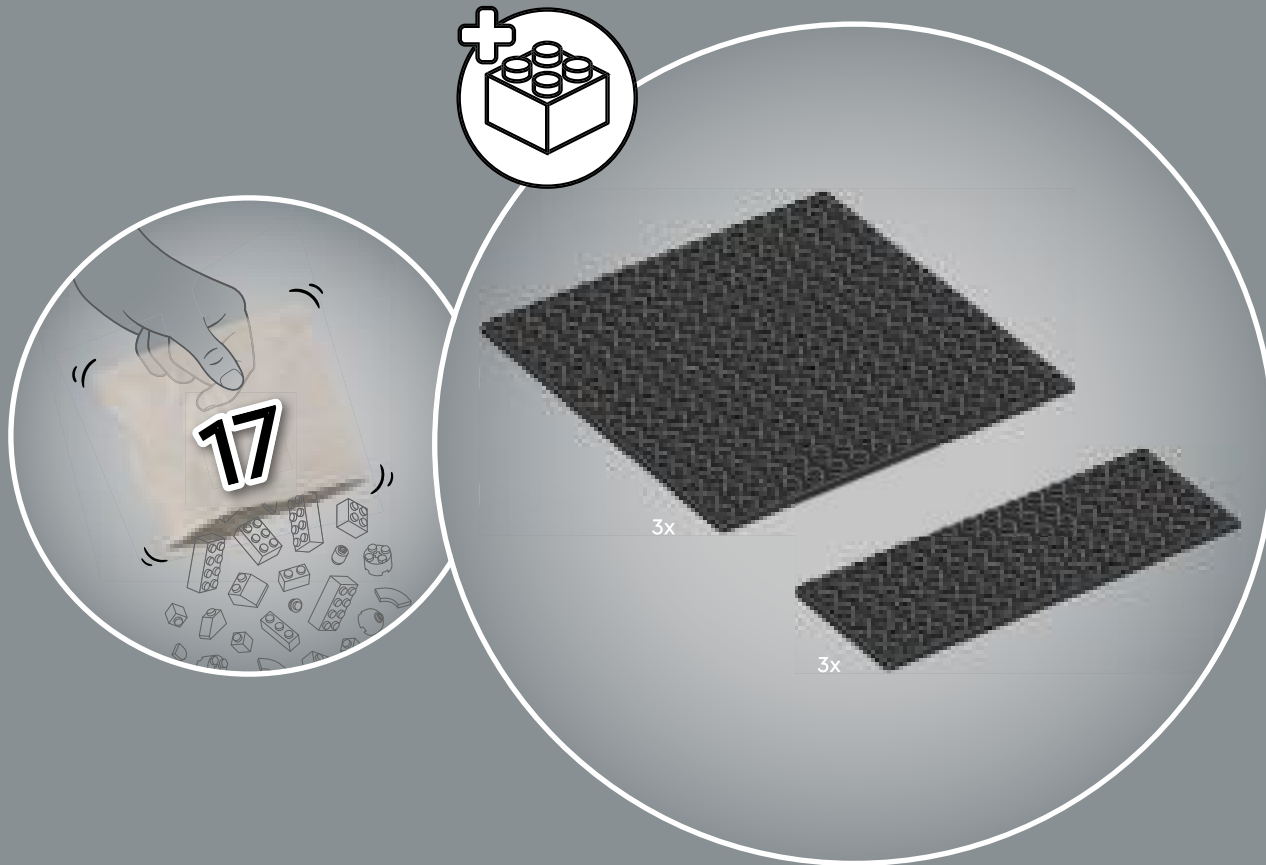

		
2x	2x	2x

225





226



227

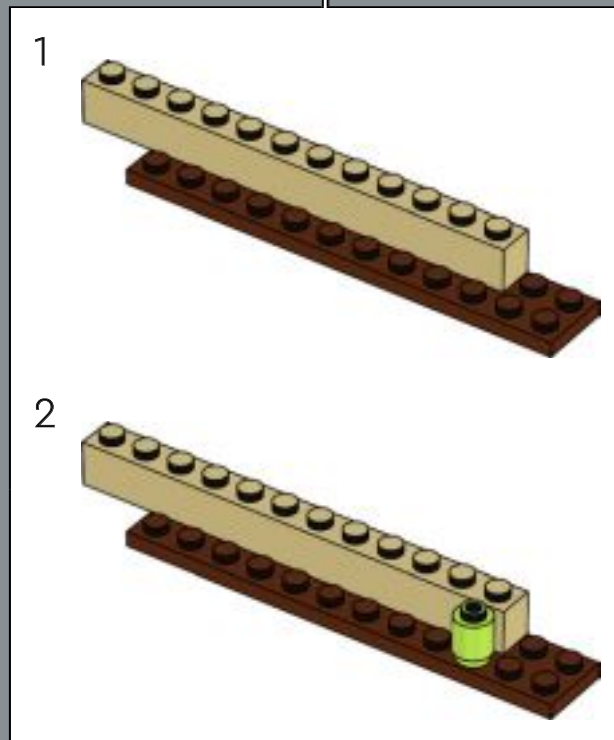
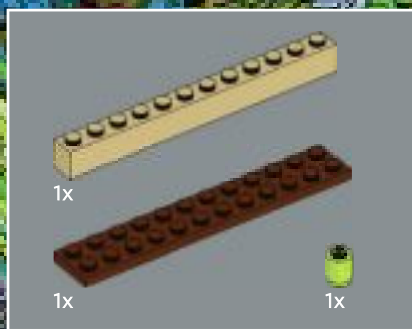

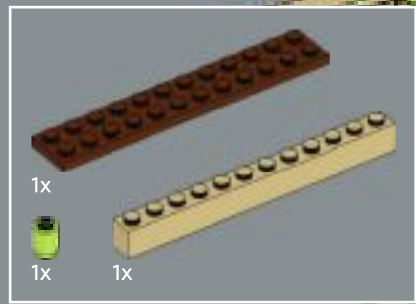

228

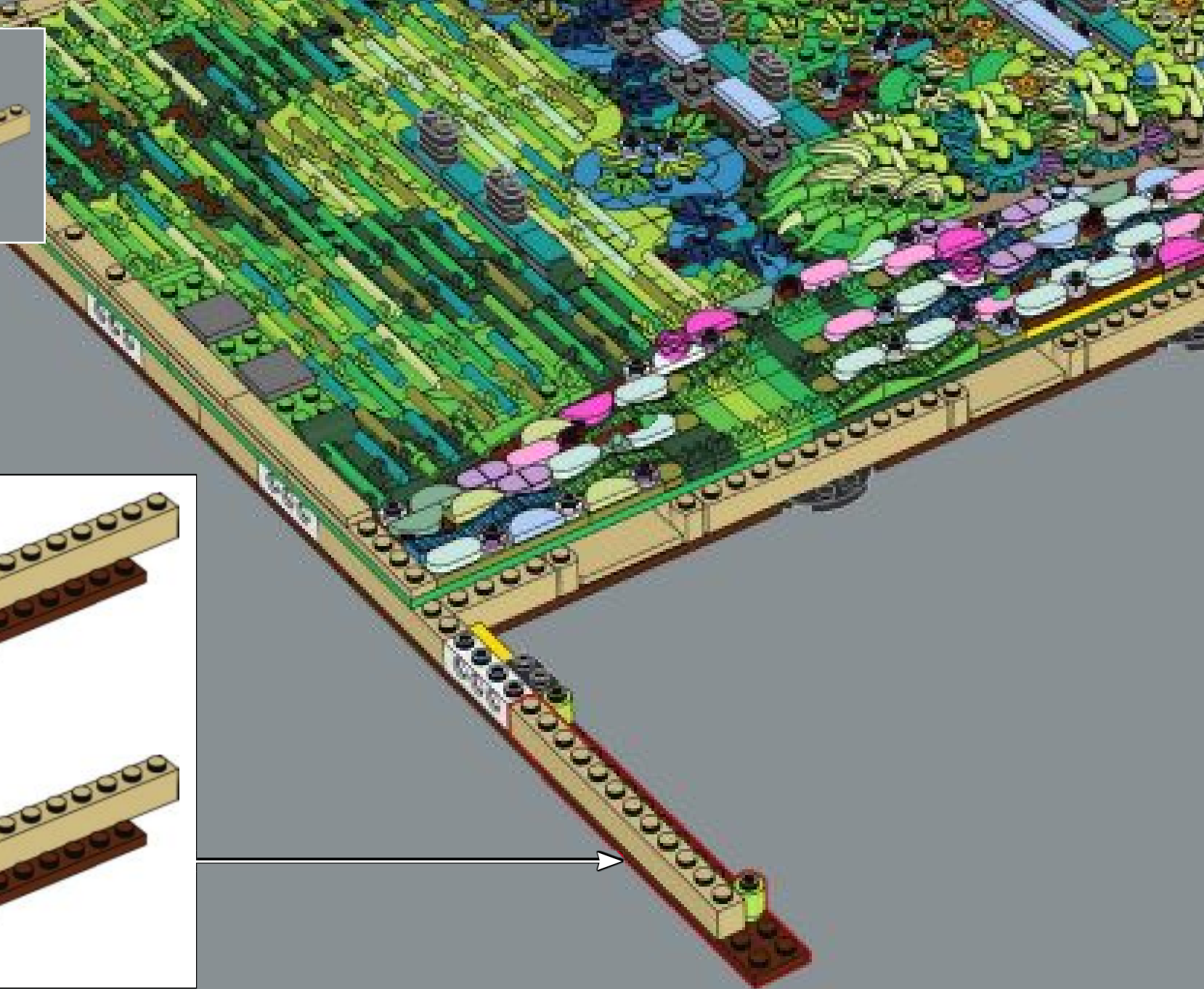
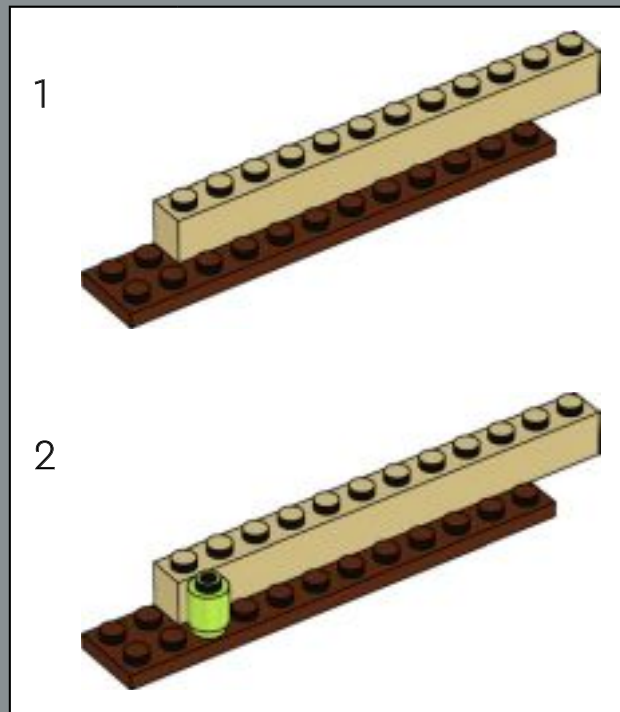

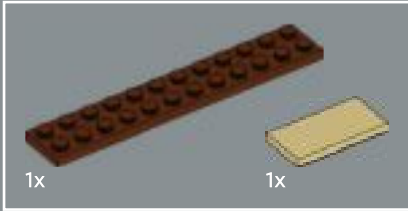
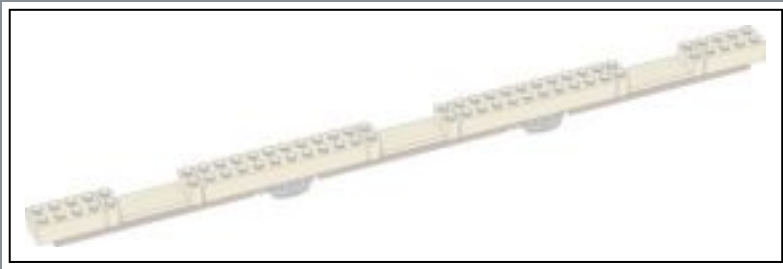

229



230

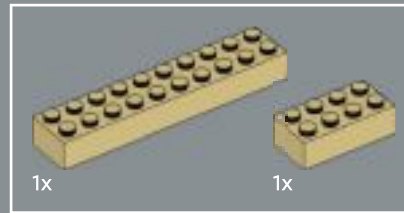
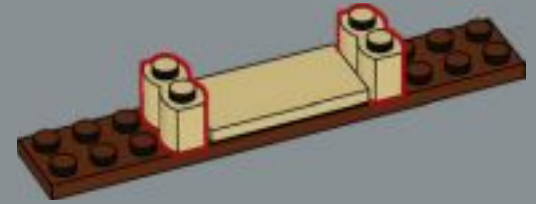

231

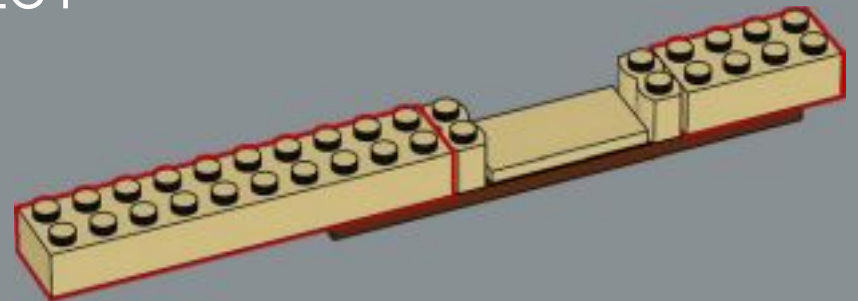

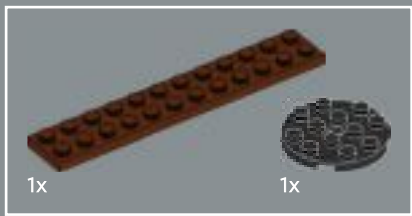

232

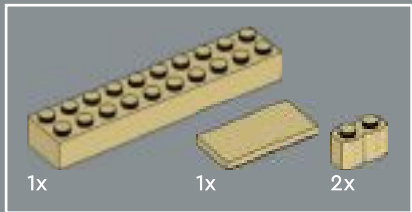
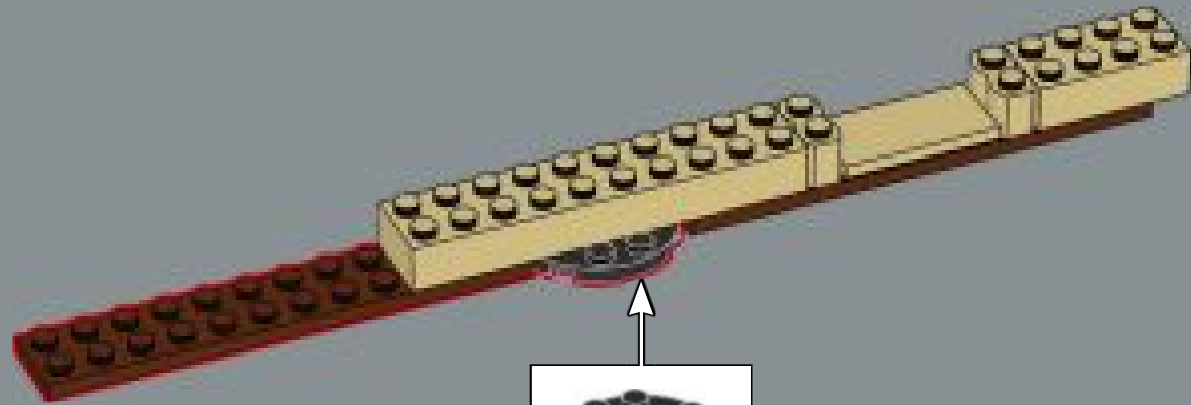

233

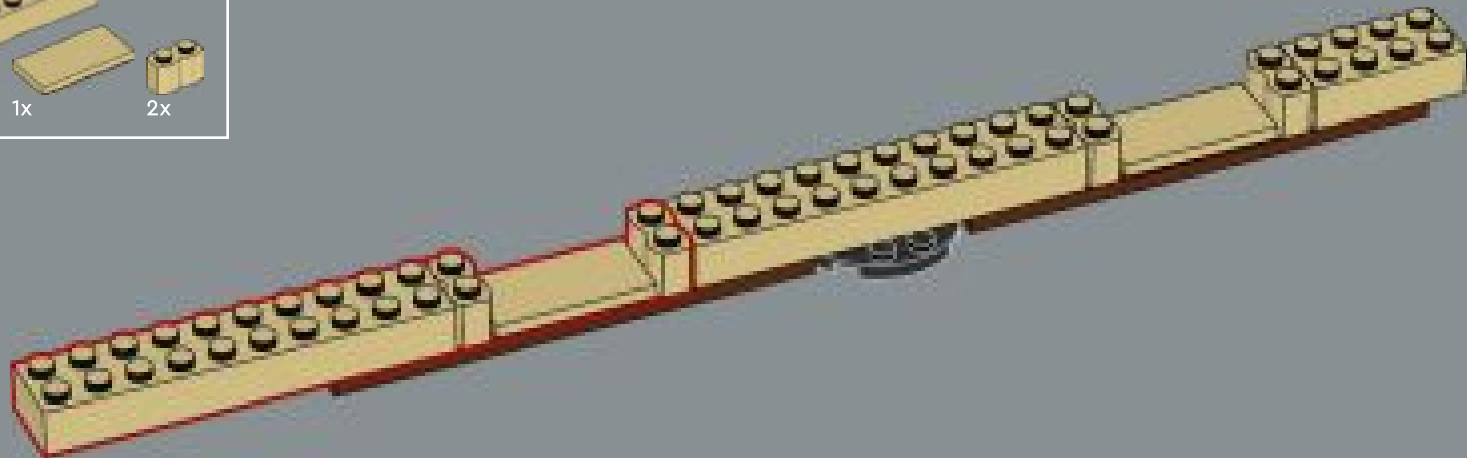

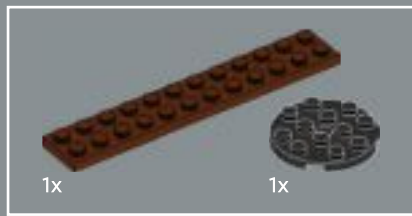

234

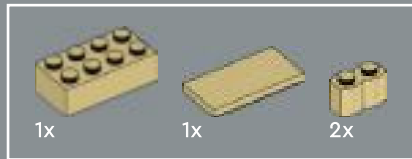
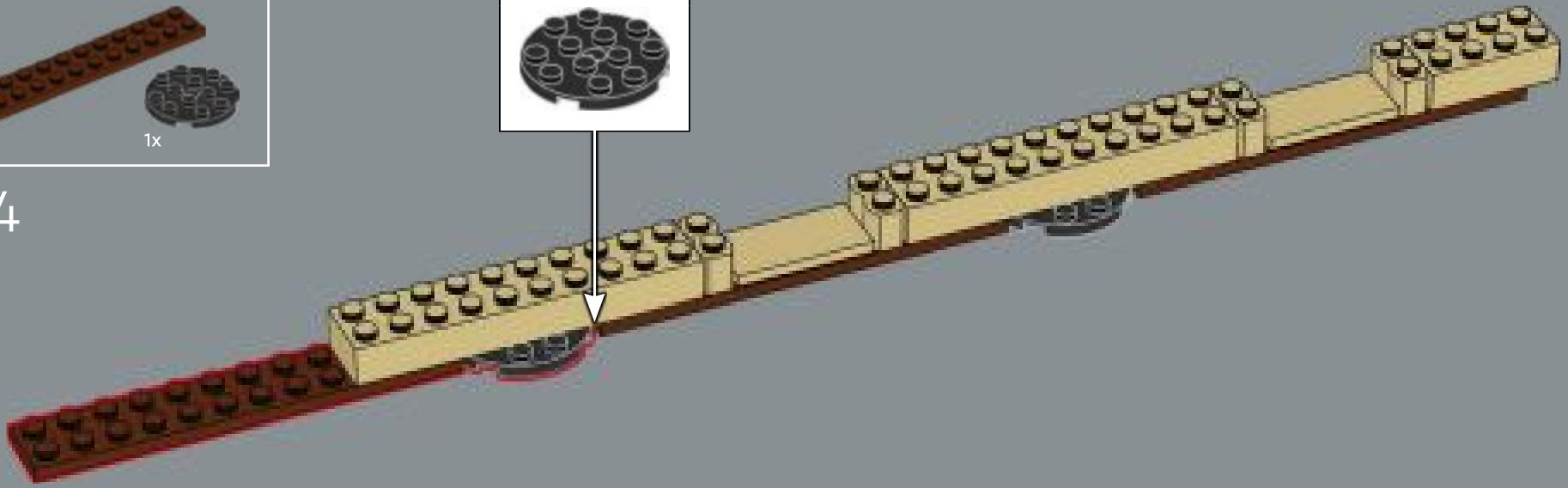

235

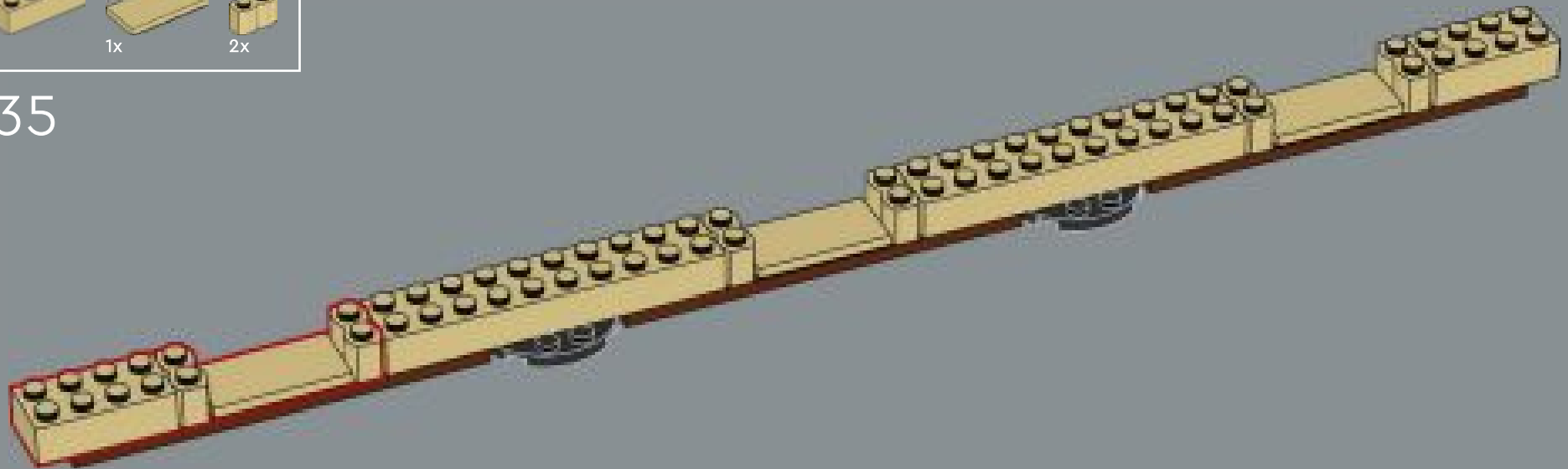

236

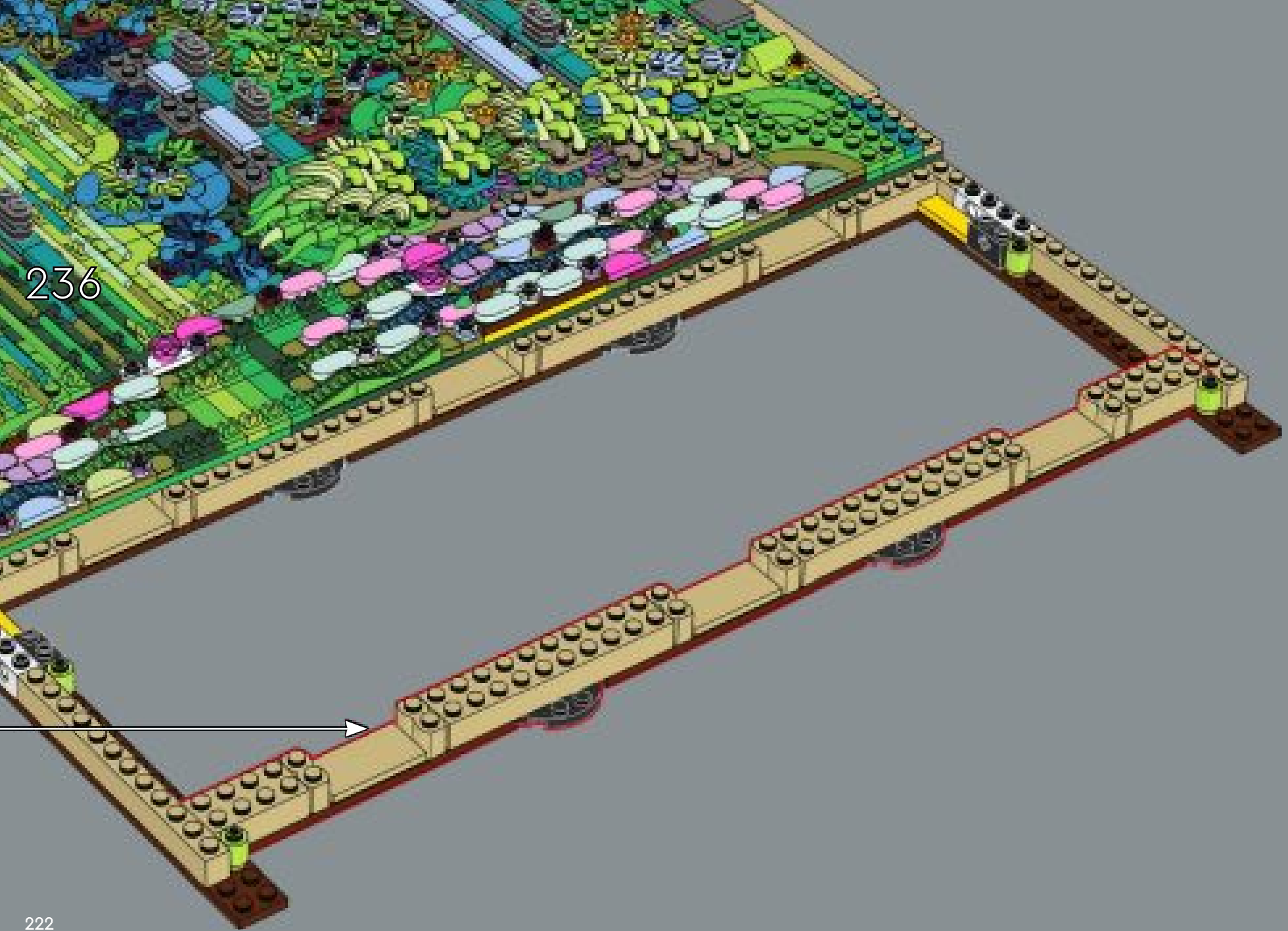

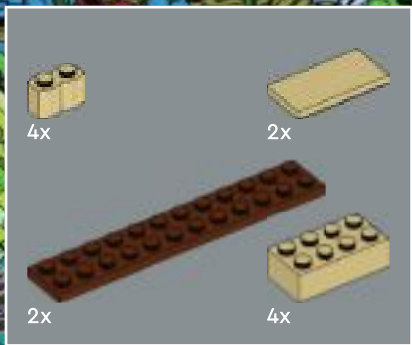

237

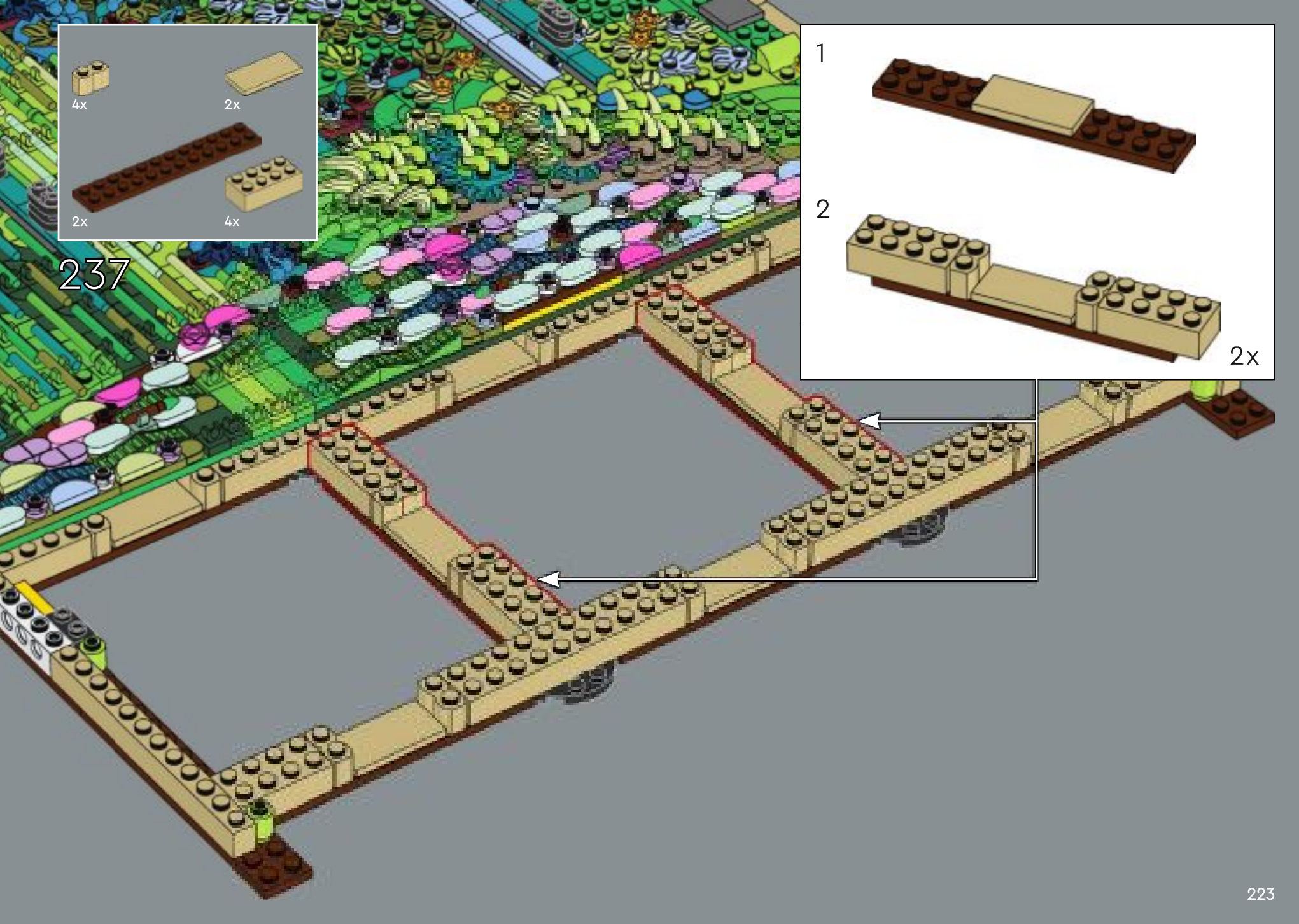
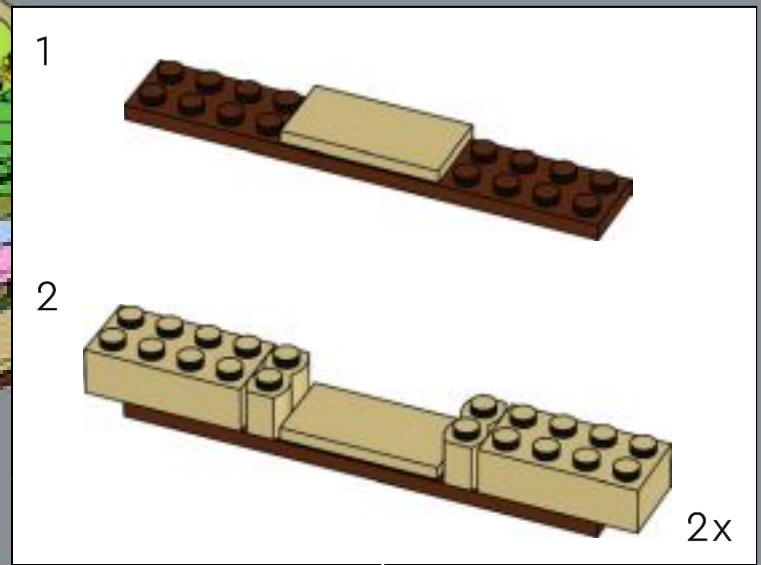

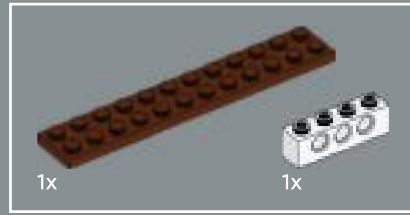

238



239



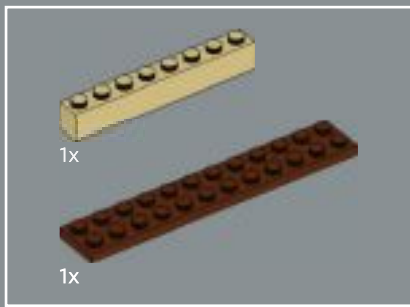

240

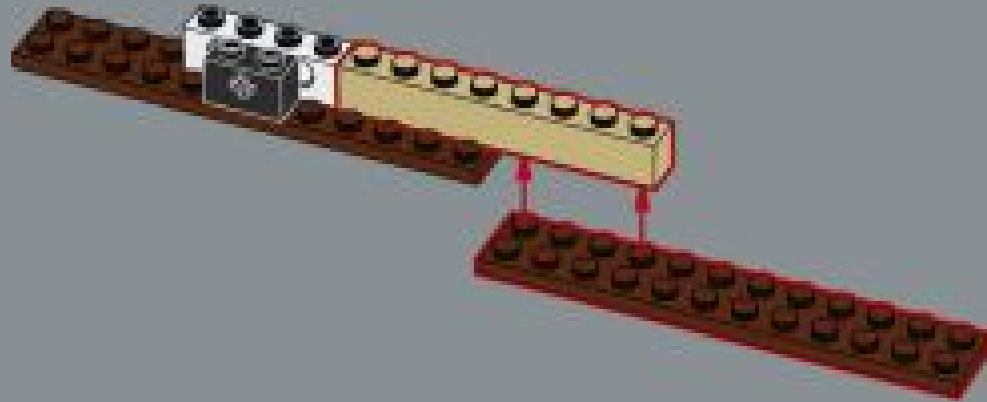

241

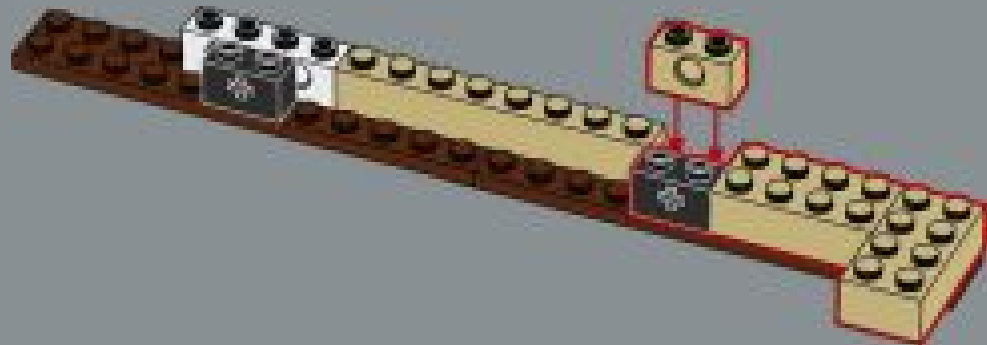

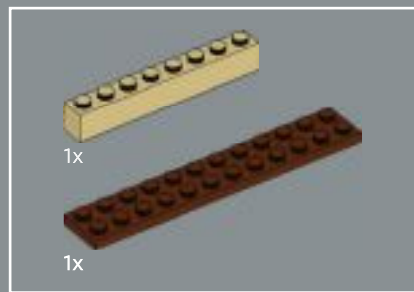

242

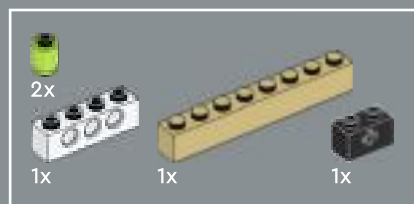
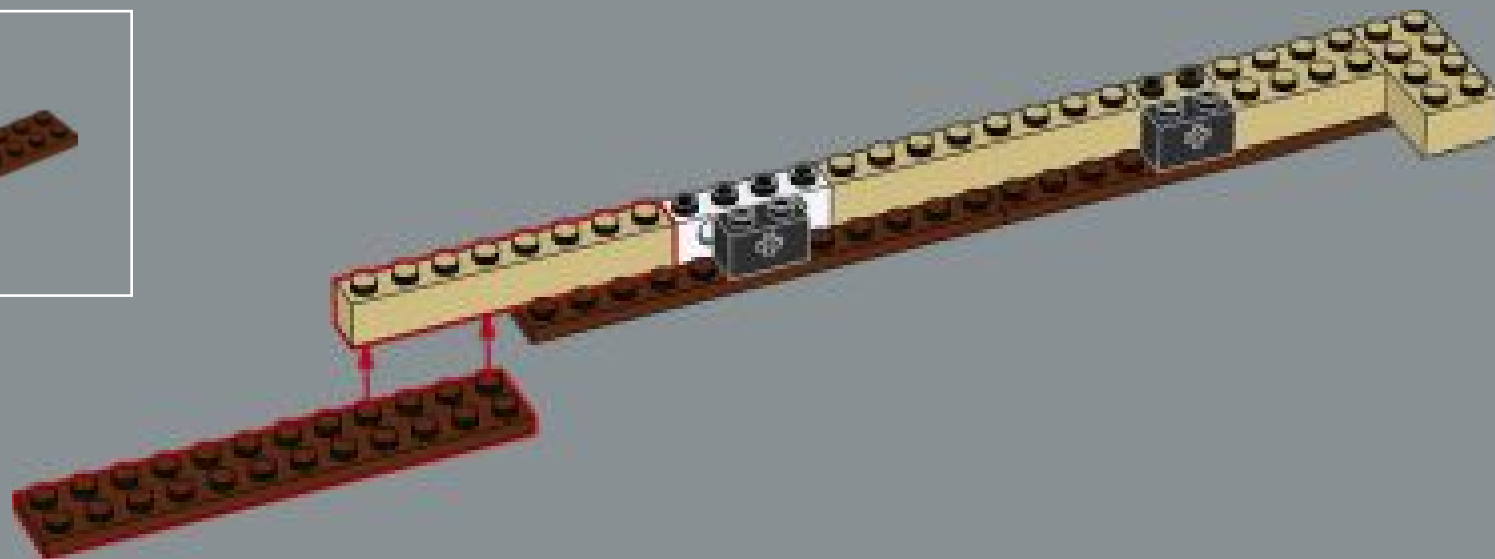

243

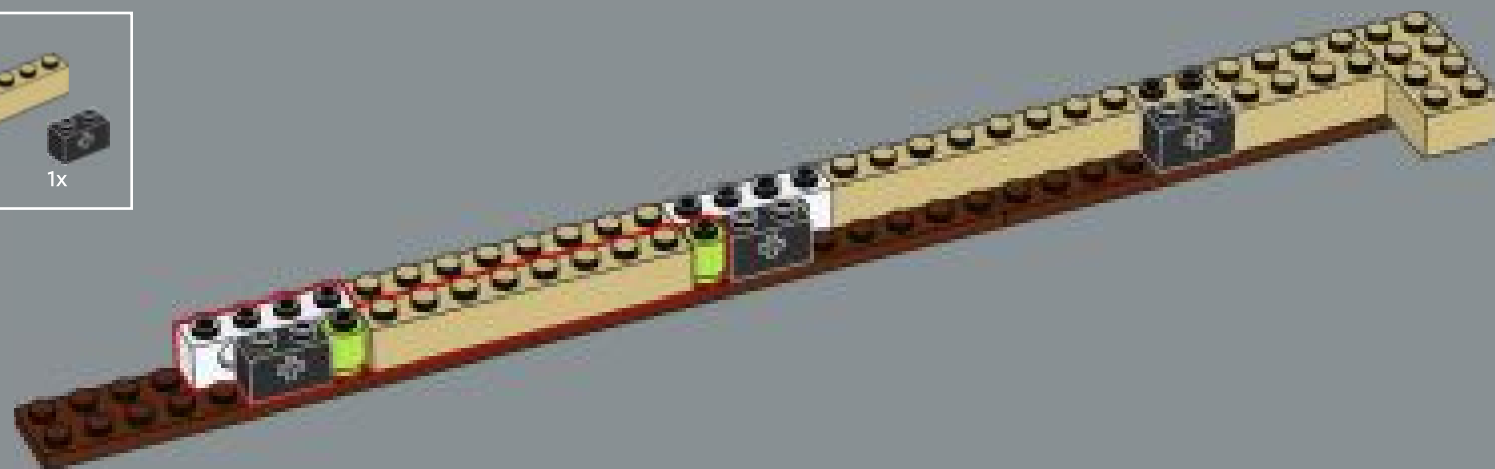

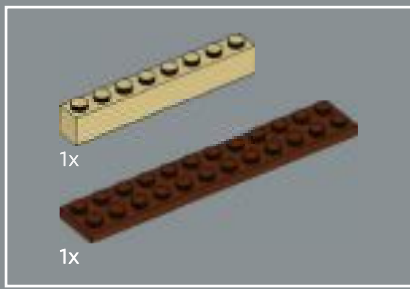

244

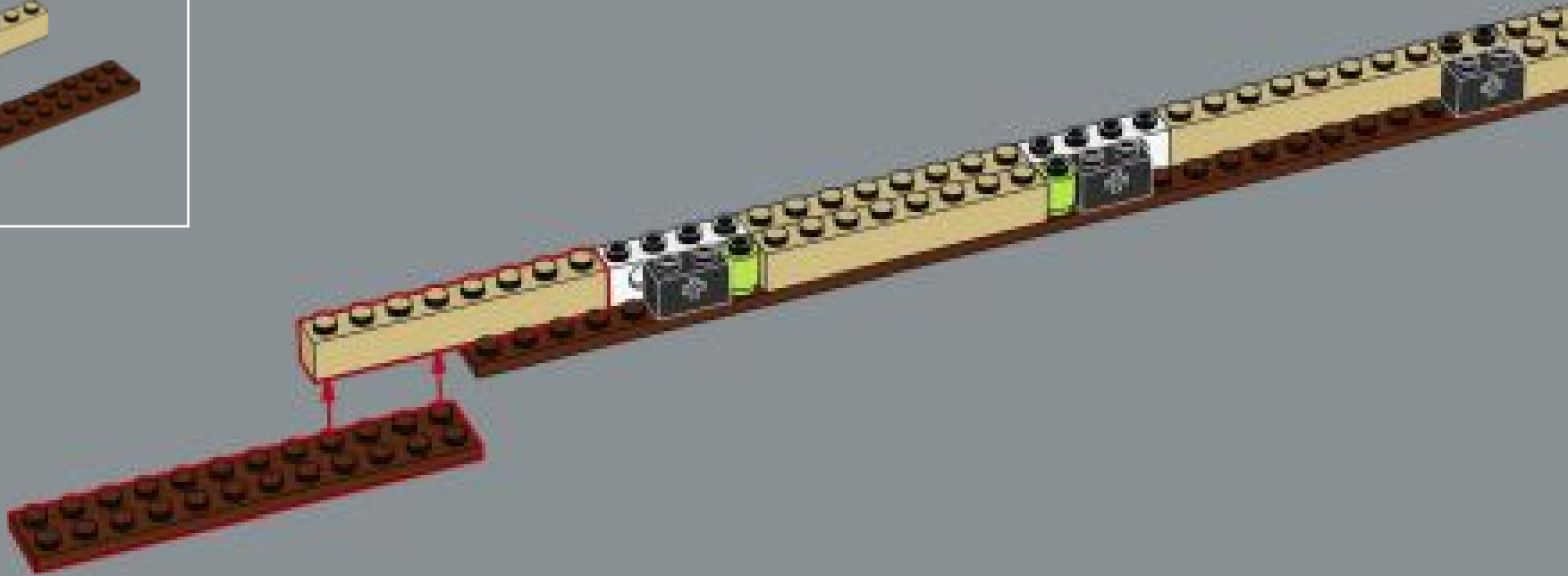

245

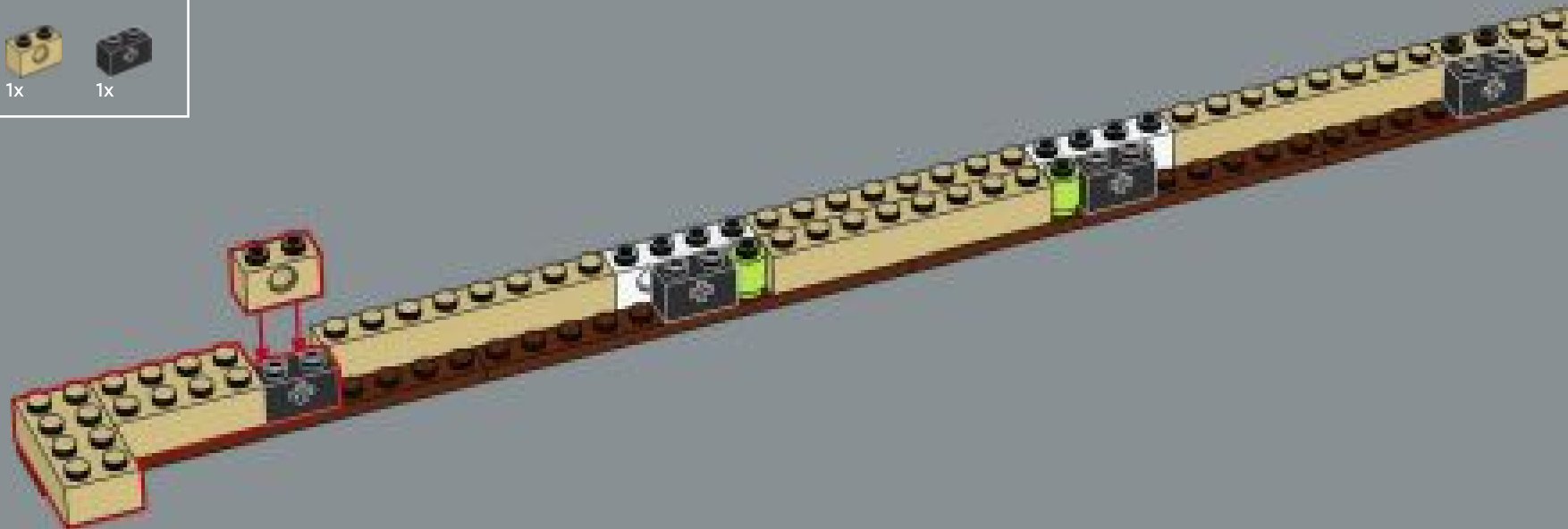

246





247



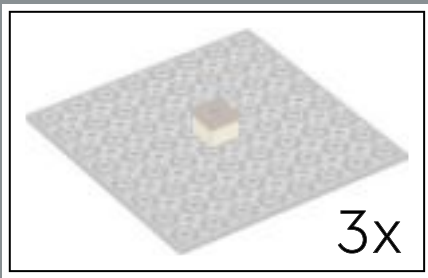

248

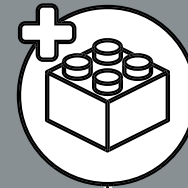
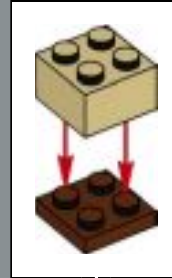

3x

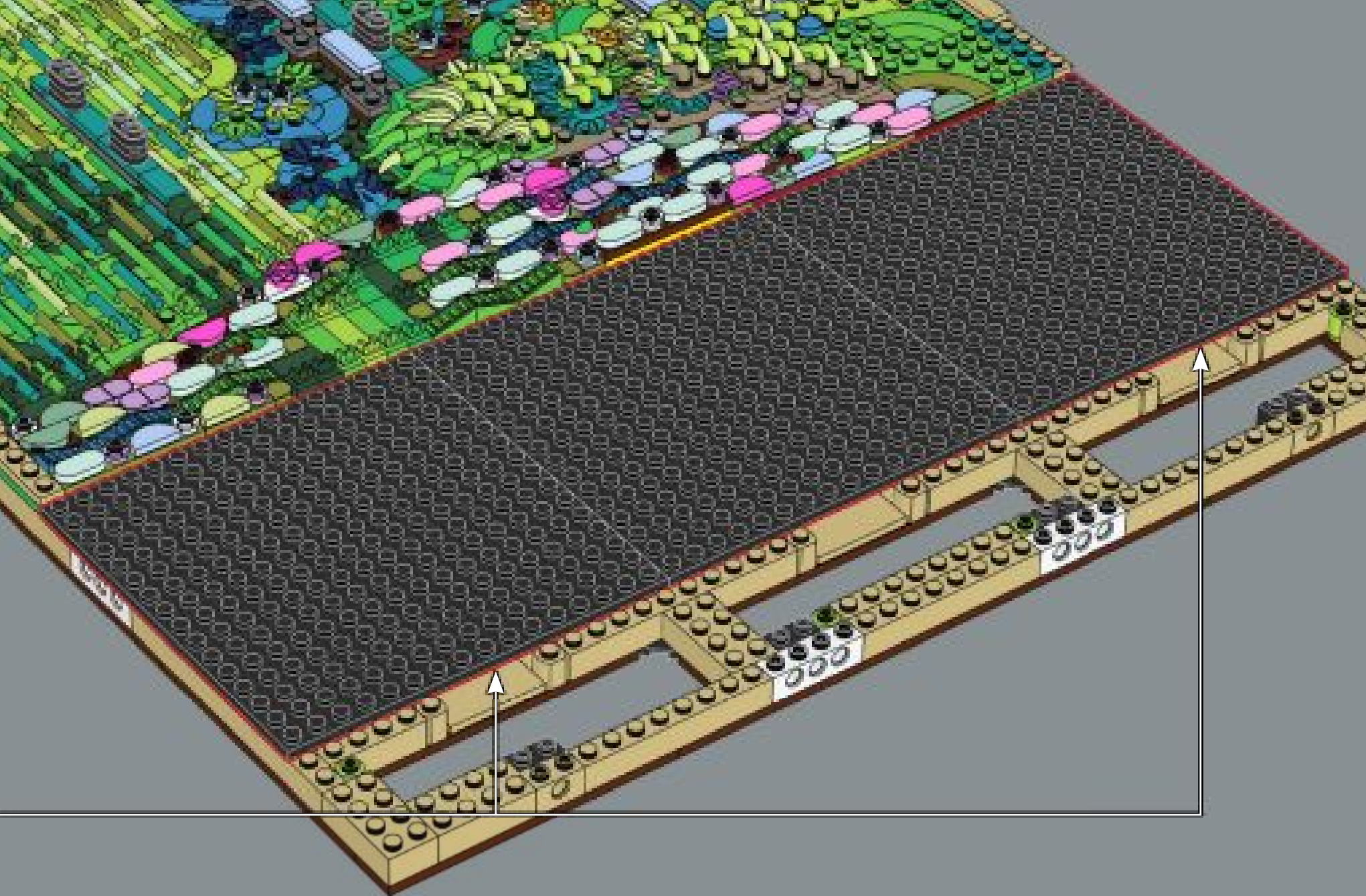



3x

249

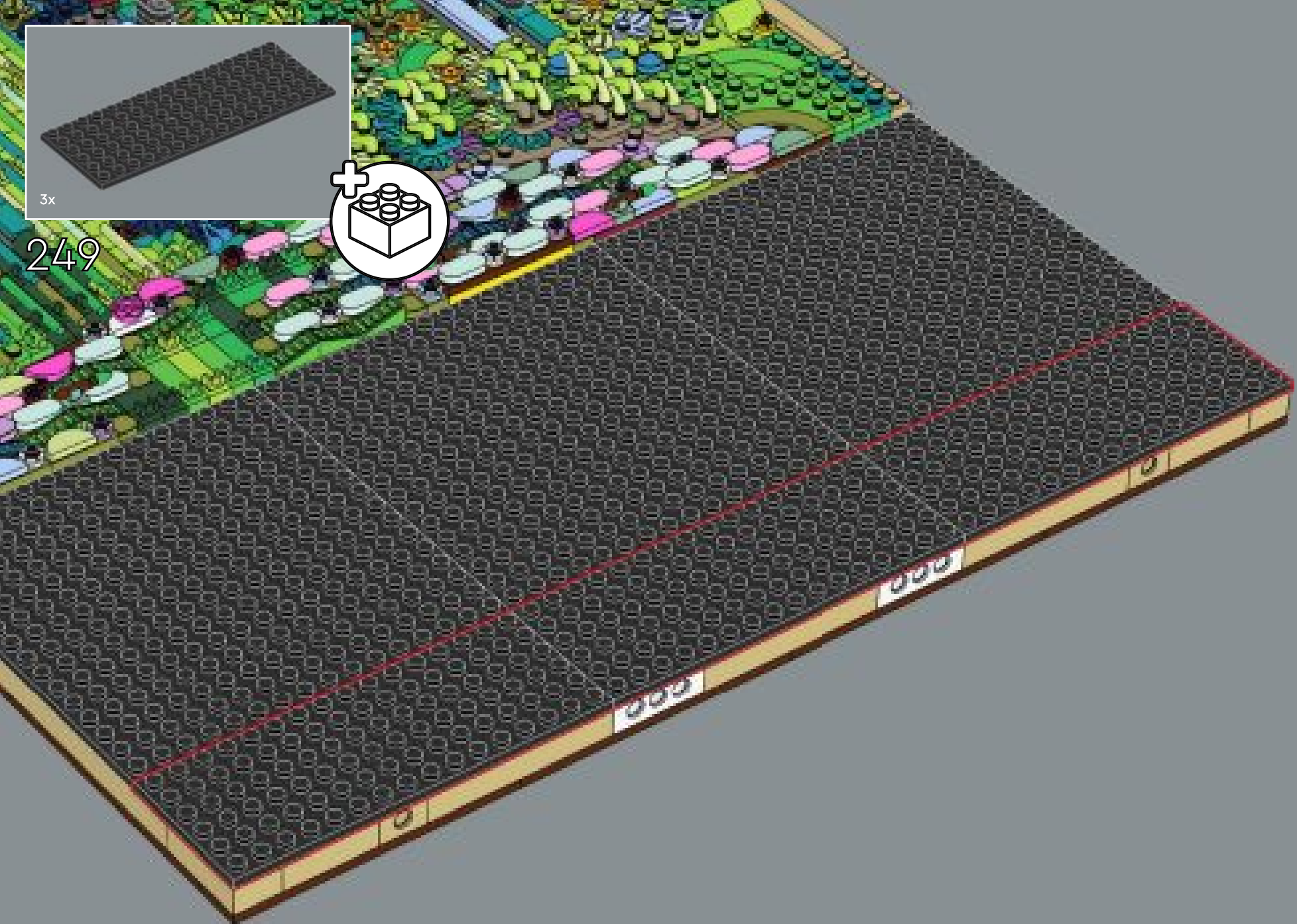
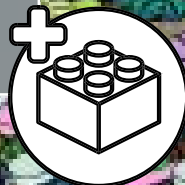

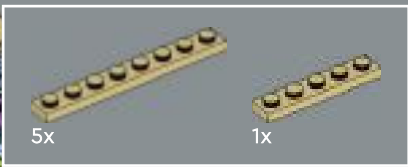

250

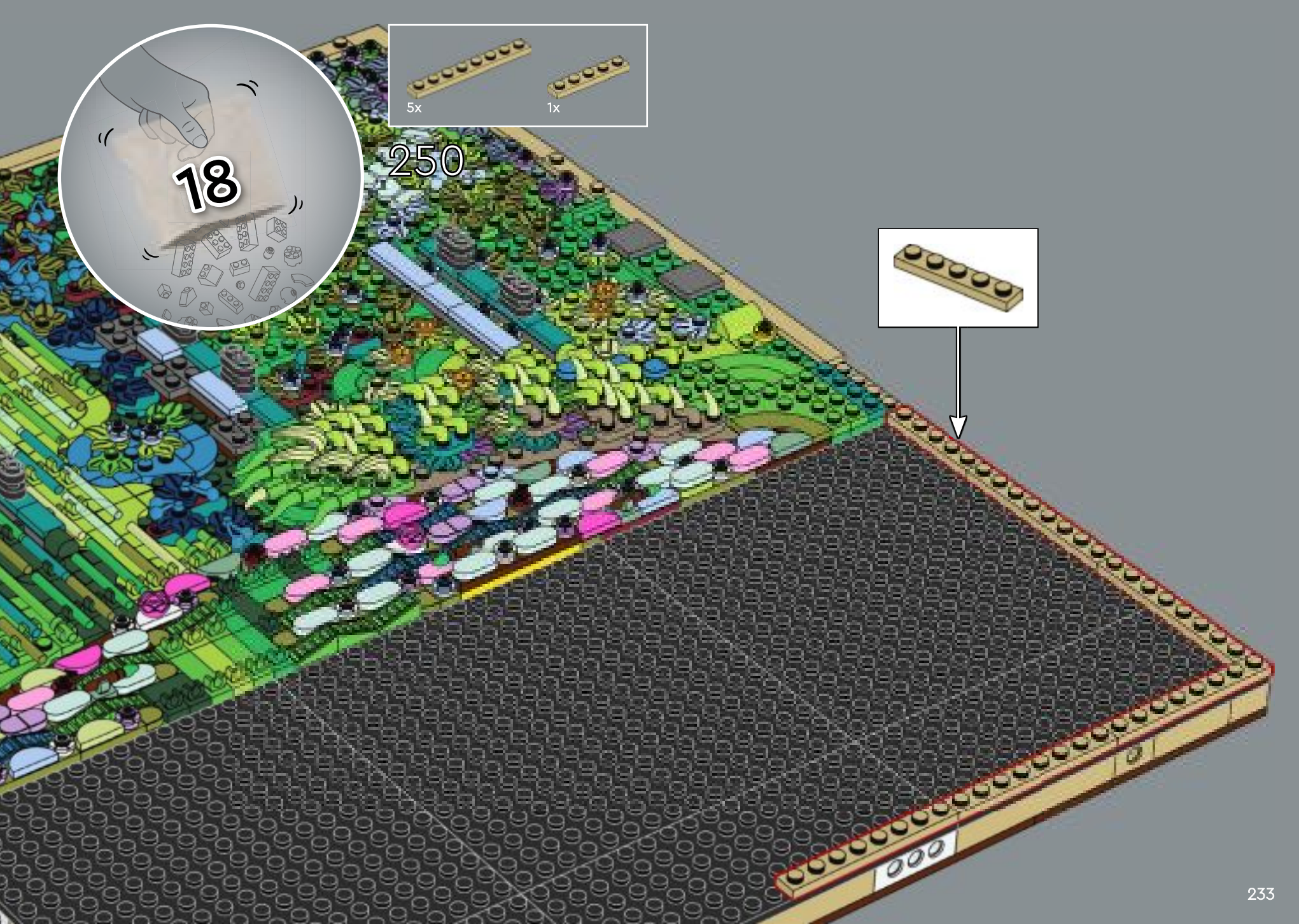

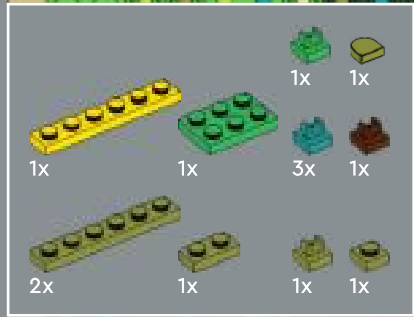

251

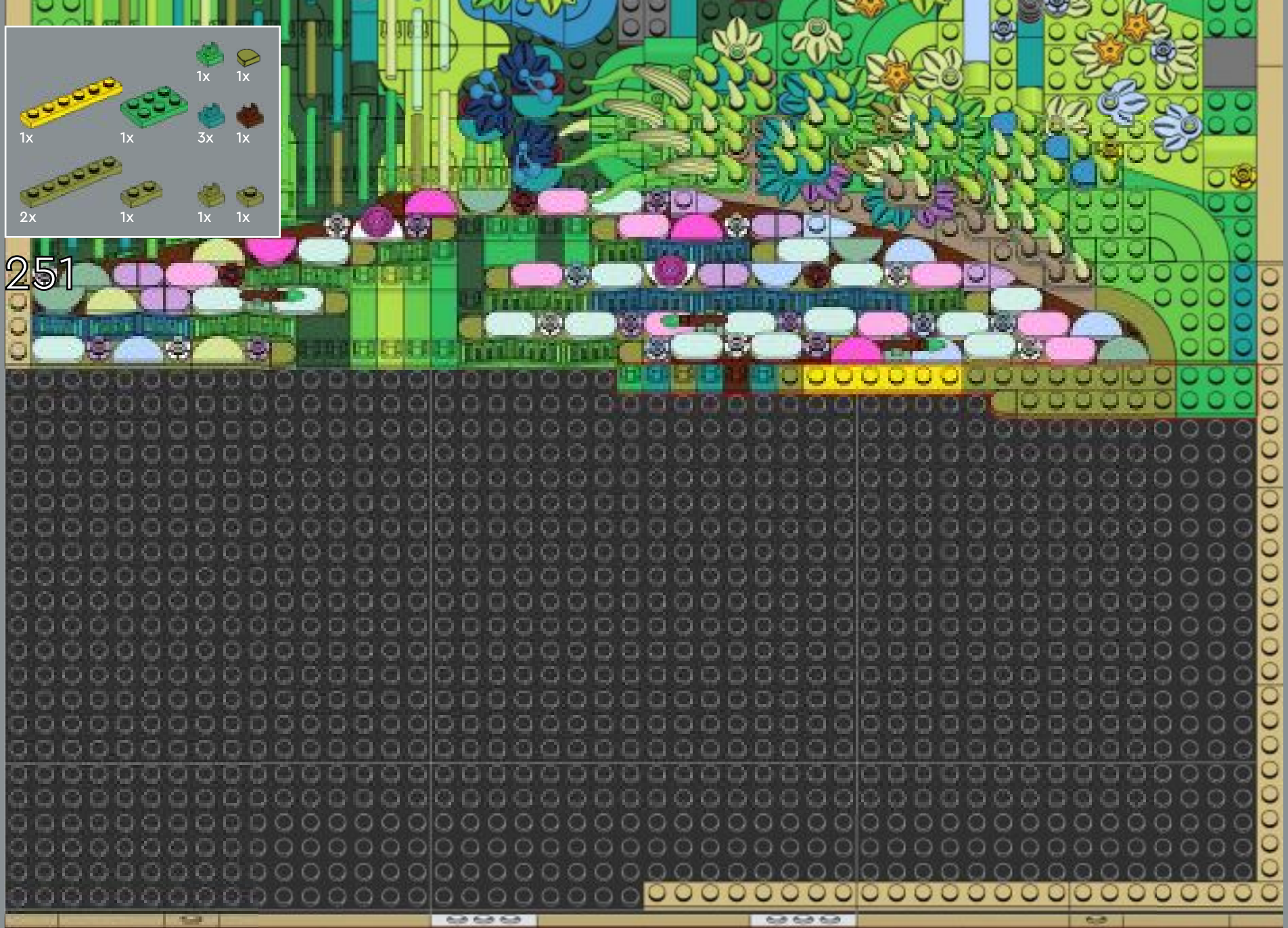

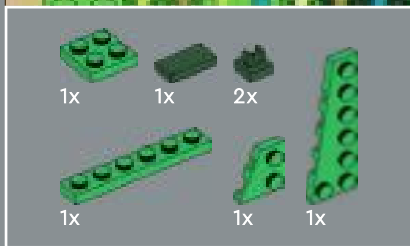

252





253



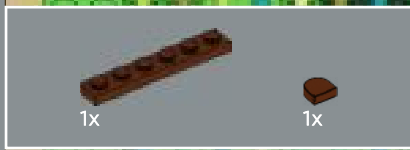

254



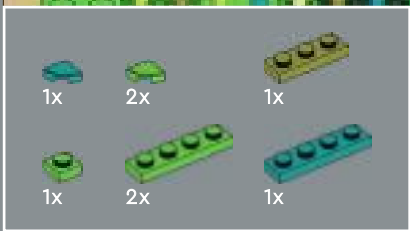

255

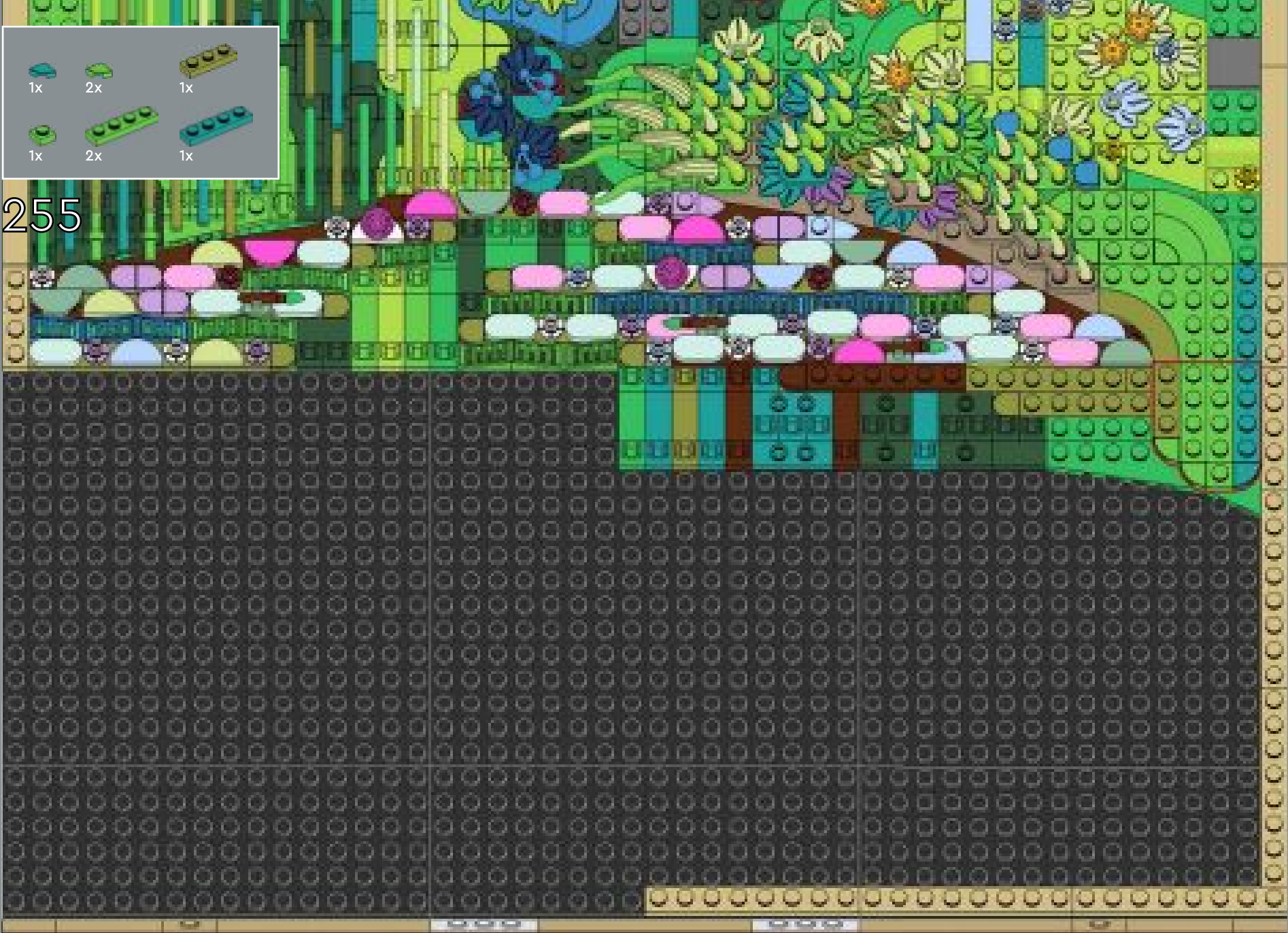

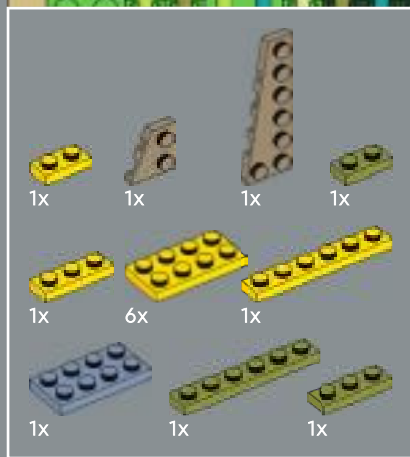



256

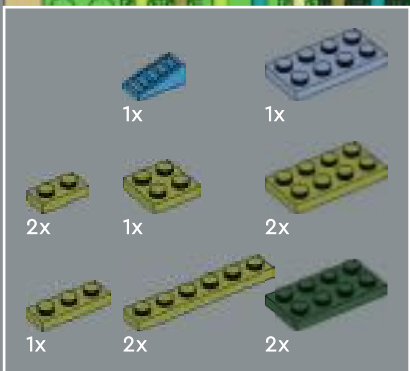

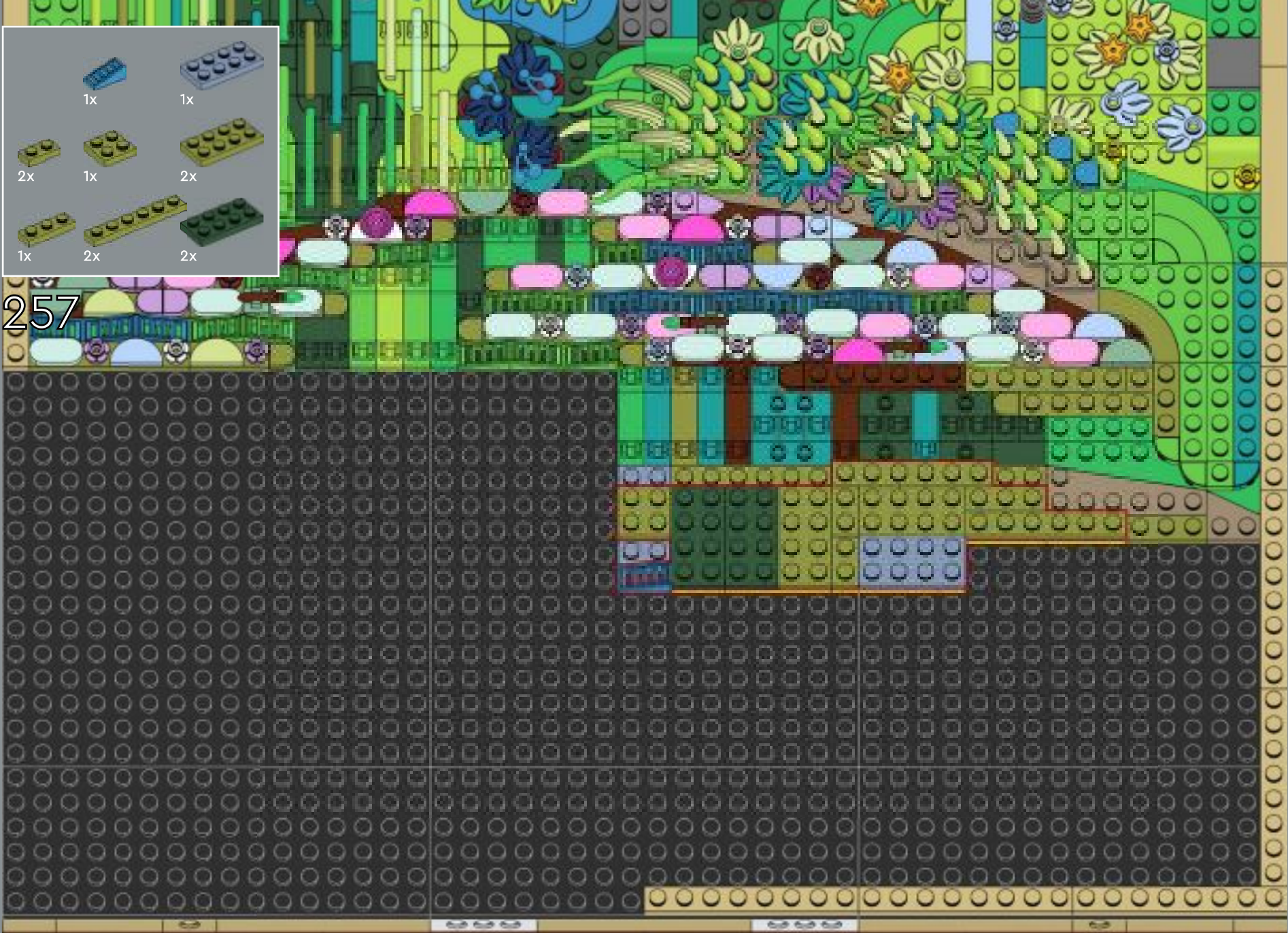

257



				
1x	1x	2x	2x	4x

258





259





260





261

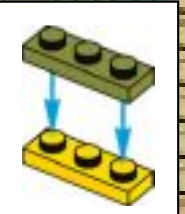
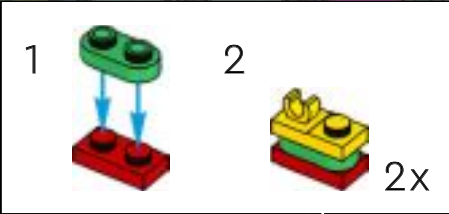



262





263





264



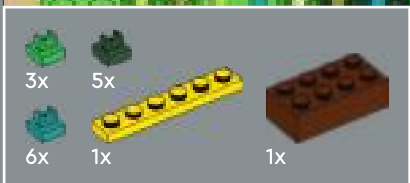

265

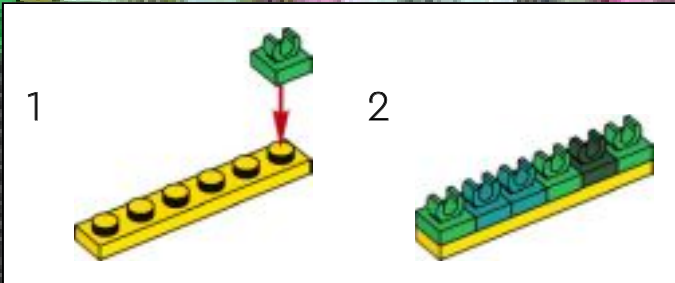



266





267



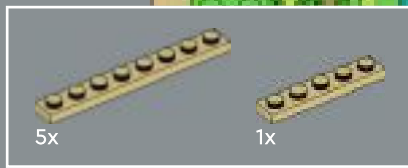

268

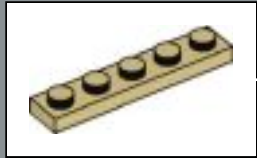

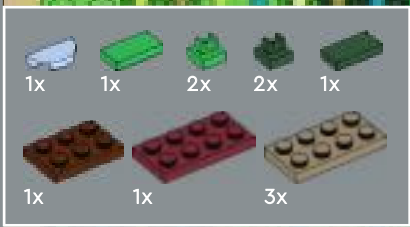







269





270



 1x
 1x
 2x
 3x
 1x
 1x

271



272

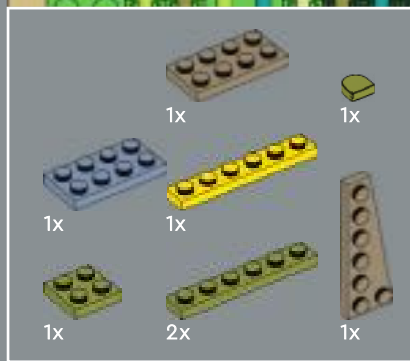

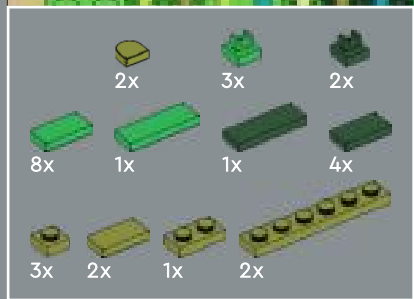

273

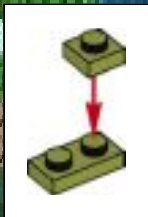

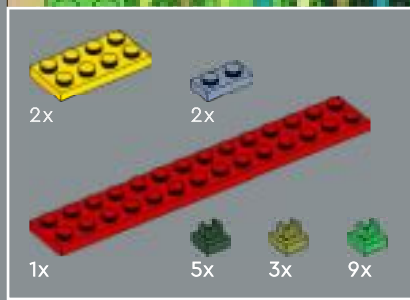

274





275





276

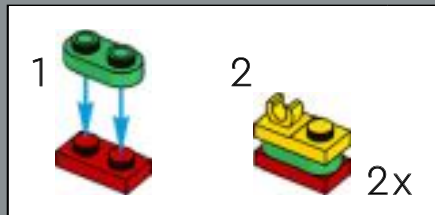



277



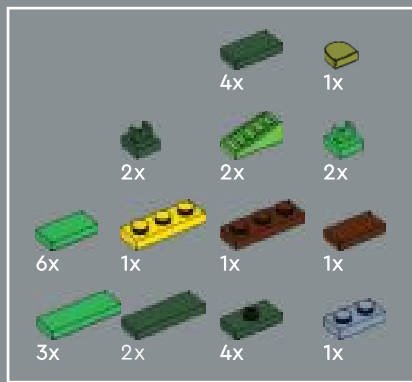

278

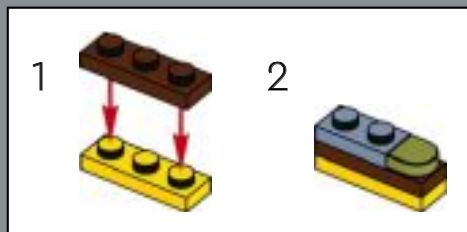



279





280





281





282





283



2x	1x	2x	1x
4x	1x	1x	1x

284



1x	2x	1x	4x	2x	3x	4x

285



			
1x	1x	1x	1x
			
1x	1x	1x	1x

286





287



Lavender-coloured carrots add a pop of colour and imitate irregular brushstrokes.

1x 2x 3x 3x 5x

288





289





290

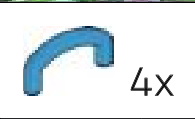

		
2x	1x	3x
		
2x	1x	3x

291



 1x	 2x	 2x	 1x
 5x	 1x	 1x	 1x





292



		
2x	3x	1x
		
3x	2x	1x

293



			
4x	1x	2x	1x

294



LEGO® katana swords depict the directionality of the vegetation as a nod to Monet's admiration for Japanese culture.



295



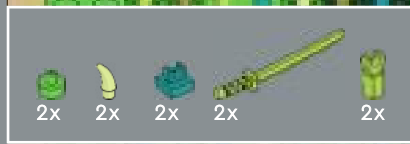

296

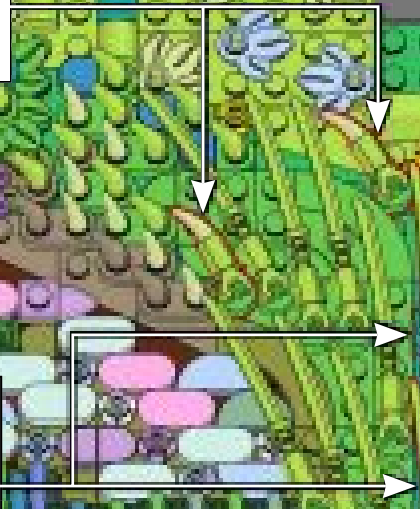
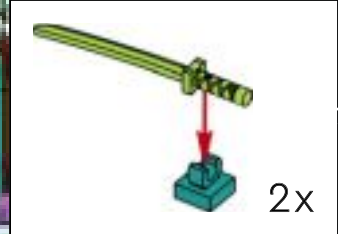
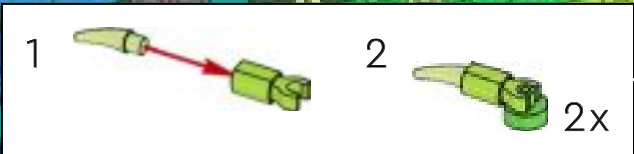



- 2x
- 2x
- 1x
- 1x
- 3x
- 1x

297

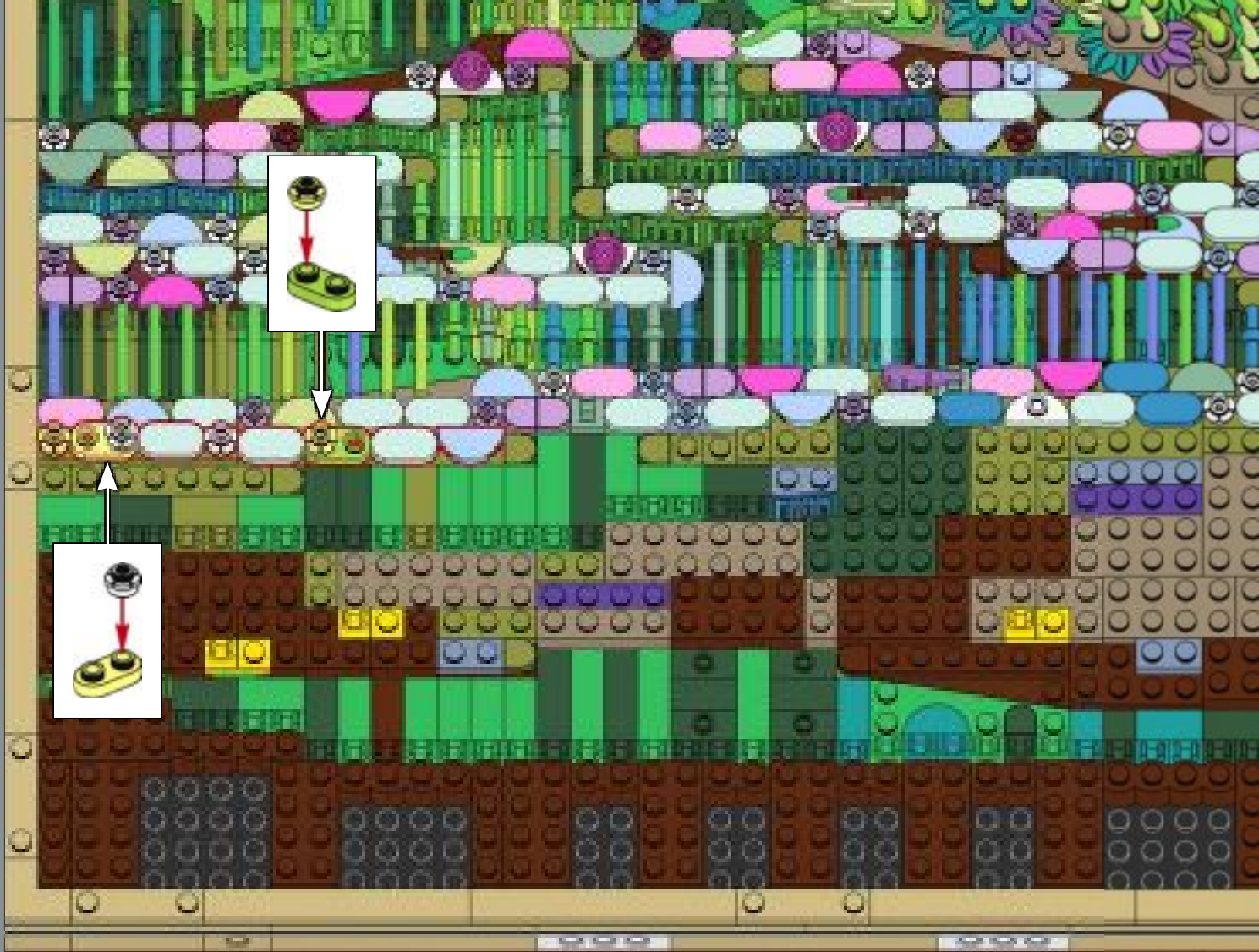



298

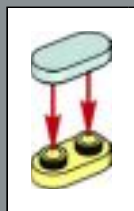



The most prominent water lilies in the painting are created by combining a plate with three leaves and a frog, mimicking the visual pop created by Monet's use of colour and brushstrokes.

			
1x	4x	1x	
			
1x	1x	1x	1x
			
2x	2x	1x	1x



299



 1x
 3x
 2x
 1x
 1x
 2x

300



1x  1x  2x 

301



- 1x
- 1x
- 1x
- 2x
- 3x
- 1x
- 2x
- 1x
- 3x
- 1x

302



					
1x	2x	1x	2x	1x	
					
1x	1x	2x	3x	1x	1x

303











2x 3x 2x

304

2x

3x

				
1x	1x	2x	1x	
				
2x	2x	1x	1x	1x

305





306



 2x	 1x	 1x
 1x	 1x	 1x



307



		
1x	1x	3x
		
3x	5x	2x







308



 2x	 1x	 4x	 1x
 2x	 1x	 1x	 5x

309



					
2x	1x	3x	1x	2x	2x



310

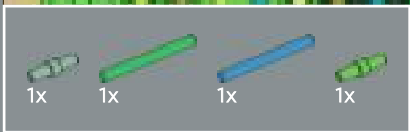



311



1x  3x 

312

3x



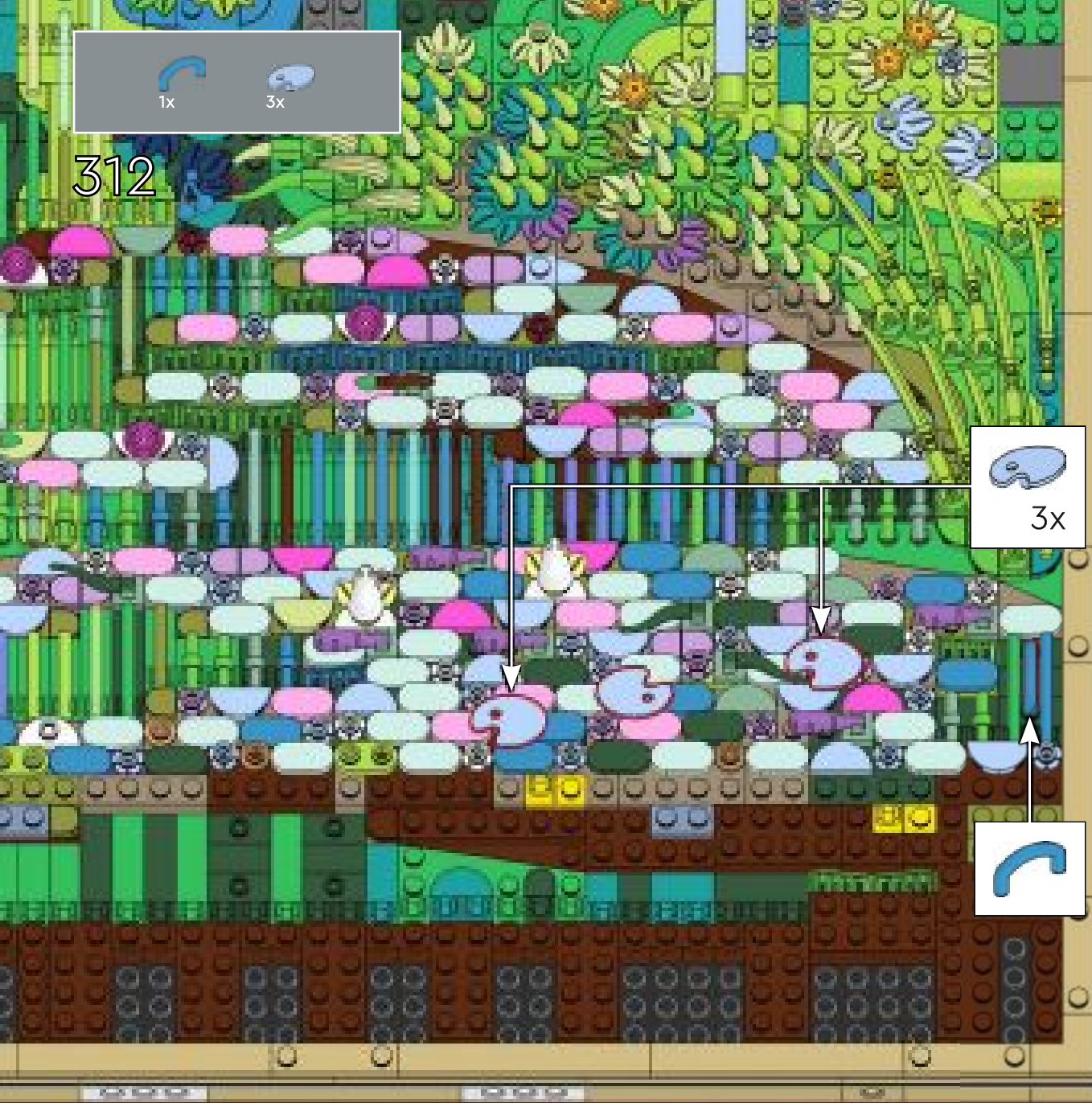



 2x	 1x	 1x	 2x	 1x
---	---	---	---	---

313



- | | | | | |
|---|---|---|---|---|
|  |  |  |  |  |
| 1x | 1x | 1x | 1x | 1x |
|  |  |  |  |  |
| 1x | 1x | 1x | 1x | 2x |

314



				
1x	1x	1x	1x	1x







315



			
1x	1x	2x	1x
			
4x	2x	1x	1x
			
1x	1x		

316



			
2x	1x	1x	
			
2x	1x	1x	2x

317



1

2



			
1x	1x	2x	2x
			
1x	3x	1x	1x
			
1x			

318



-  2x
-  1x
-  1x
-  2x
-  2x
-  2x
-  1x

319



2x 2x 5x 2x 3x

320





321



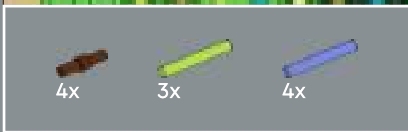

322



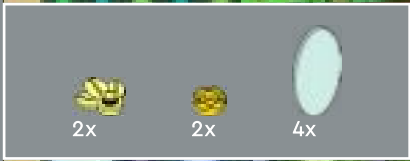

323

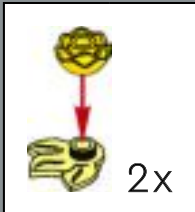

To depict the lily pads closest to the viewer's eye, we used aqua-coloured oval LEGO® shields.



2x 7x

324



7x



2x

 2x
  2x
  2x

325

 2x

 2x



326





327





The row of wedge plates in brown and dark brown is added to represent the shadow and reflection of the bridge.

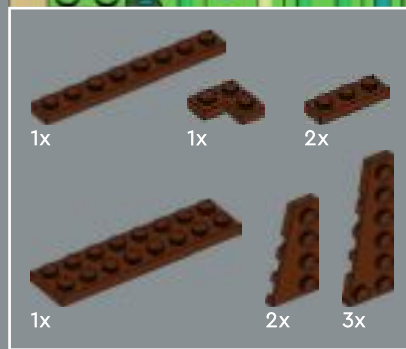

328





329





330



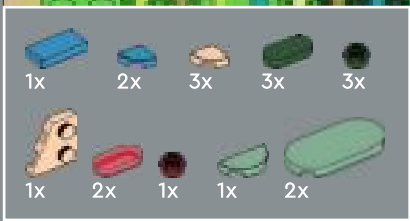



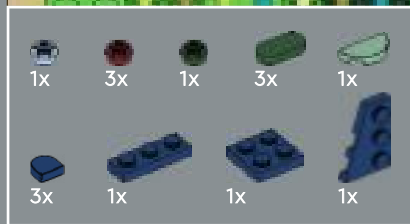

331





332



 1x	 1x	 2x	 1x
 2x	 2x	 2x	 1x









333





334



 1x	 2x	 1x	 2x
 1x	 1x	 1x	 1x

335



2x 1x 1x

336



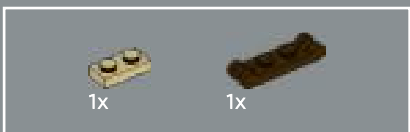
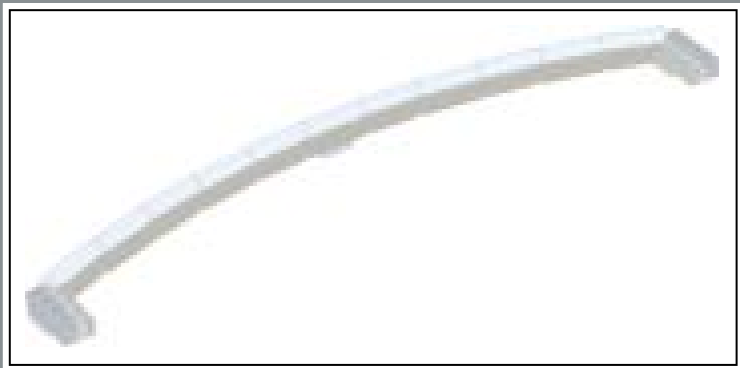

337



338



339

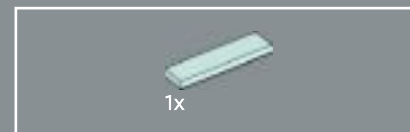

340

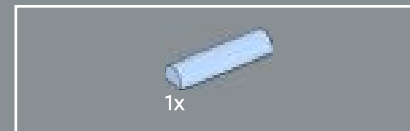
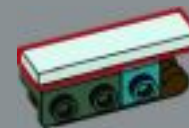

341

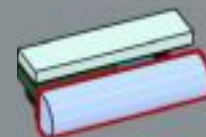



342

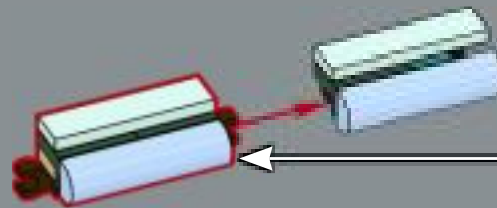

343

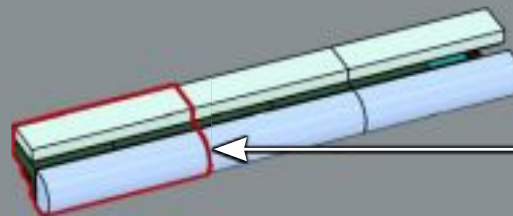



344

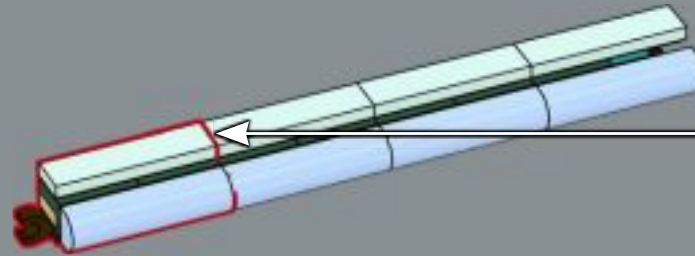

345

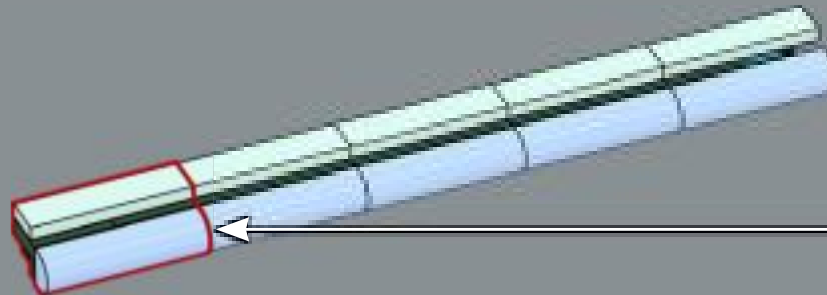

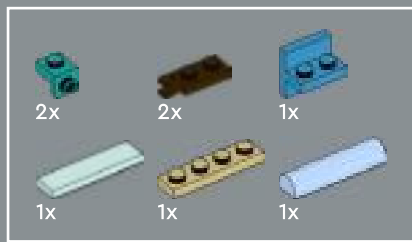

346

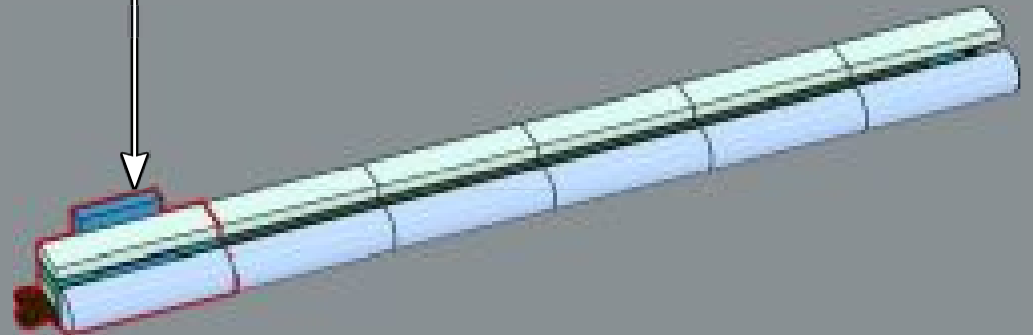
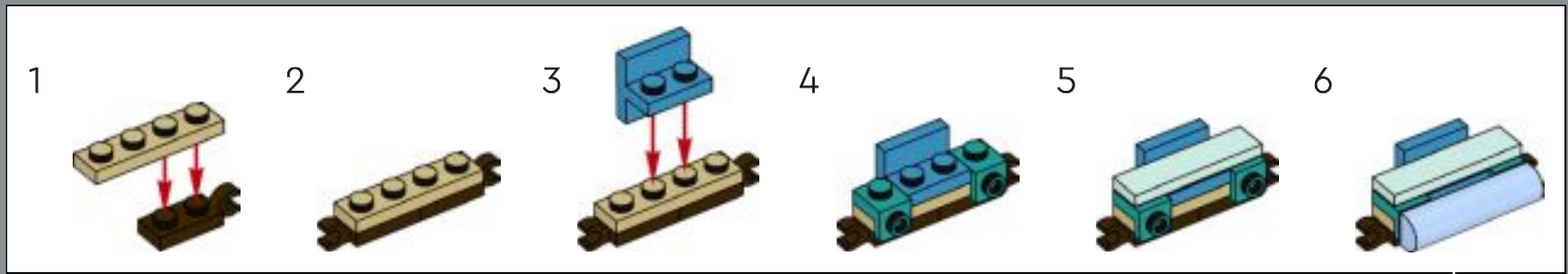



347

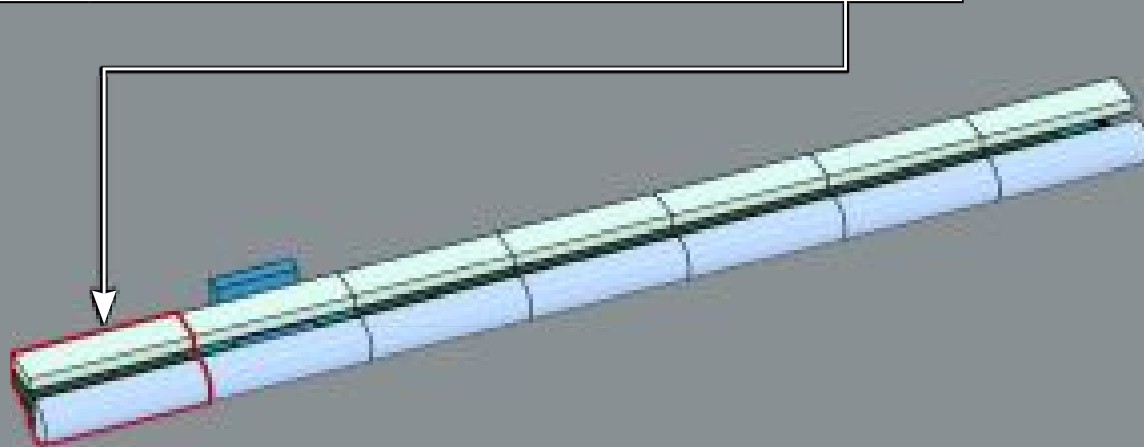



348

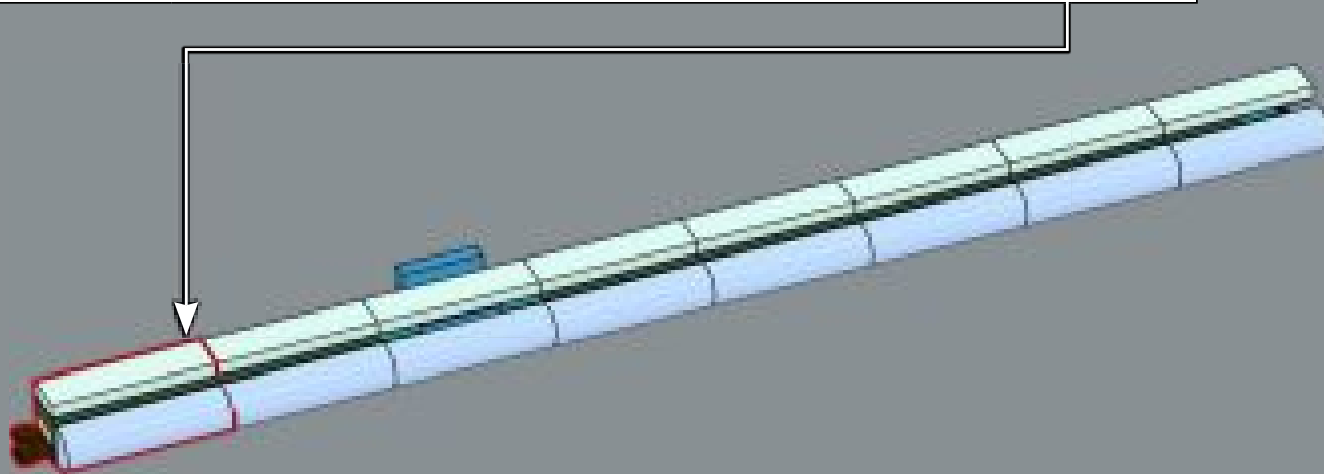



349

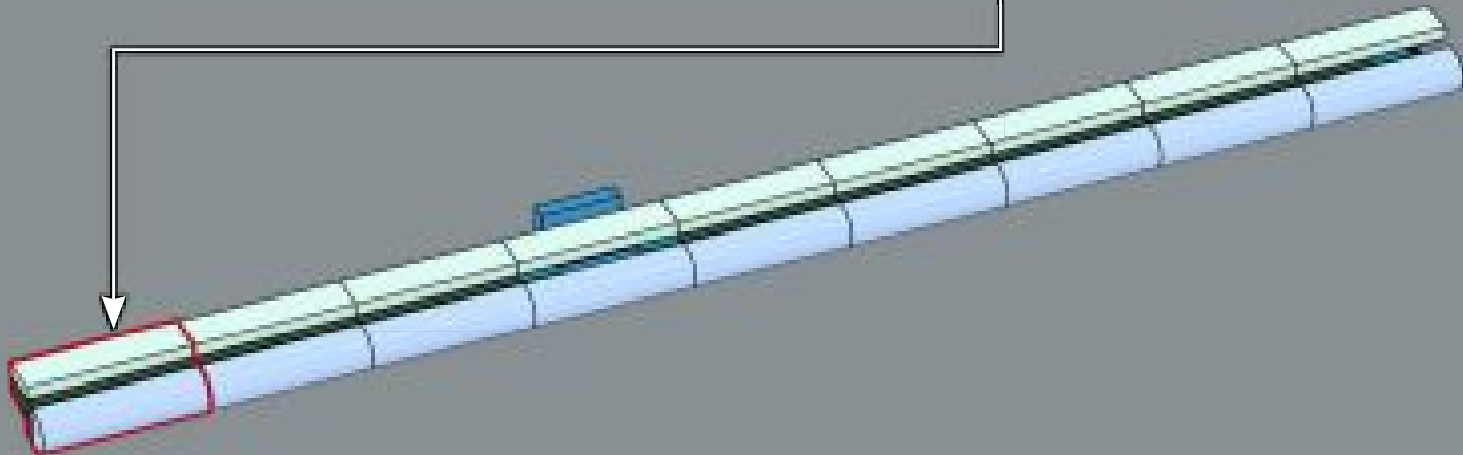

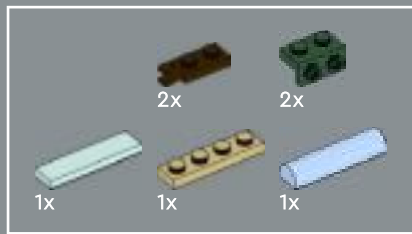

350

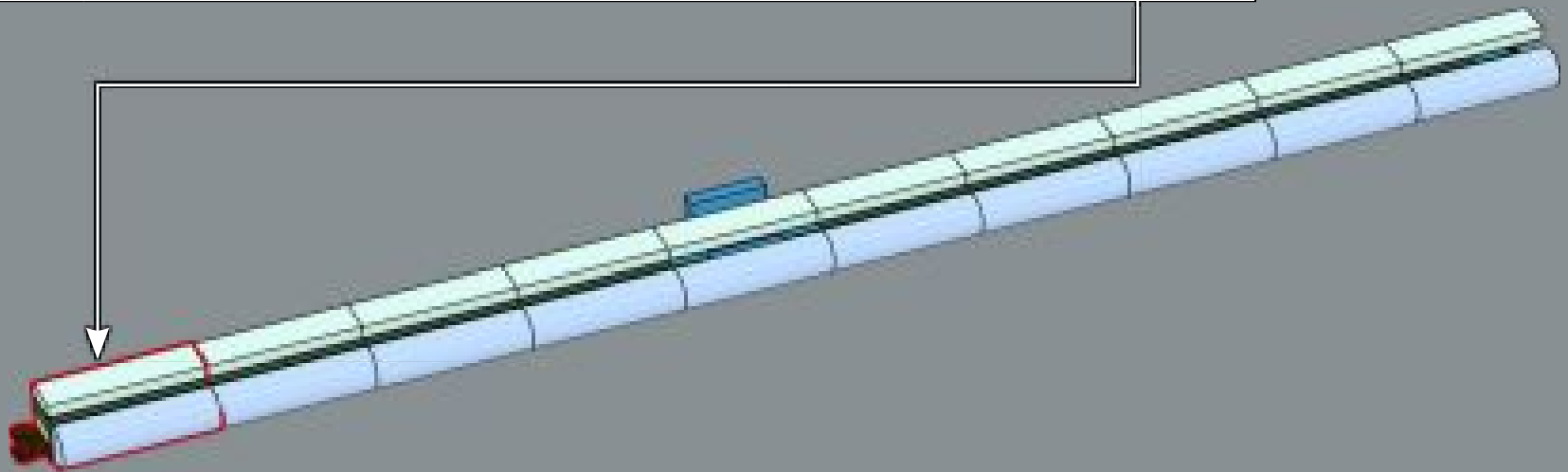



351

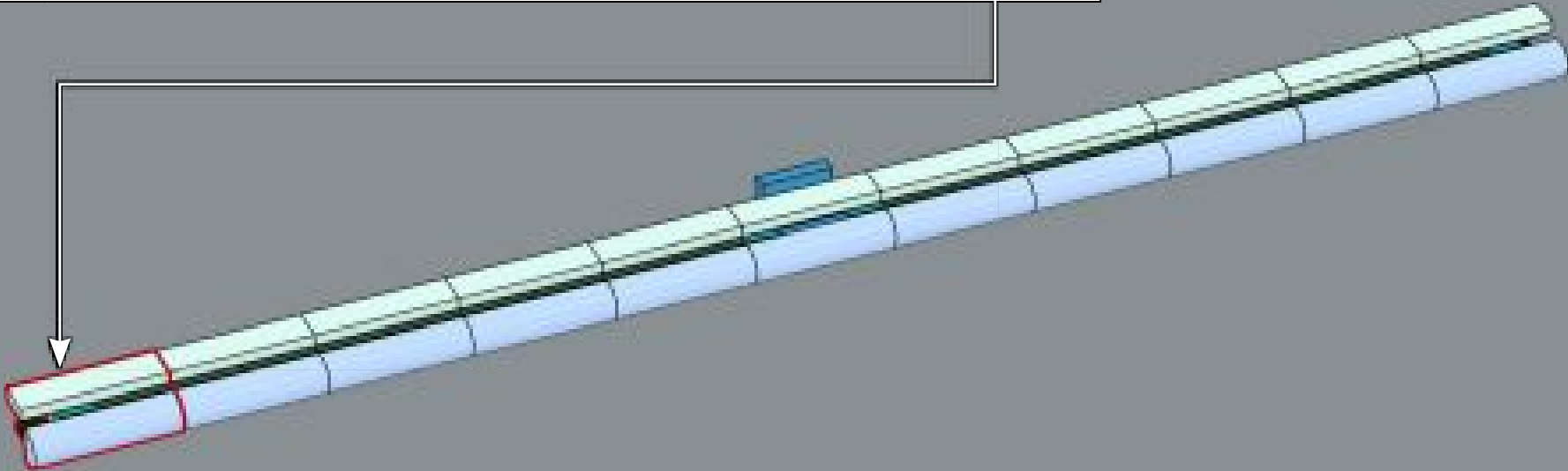

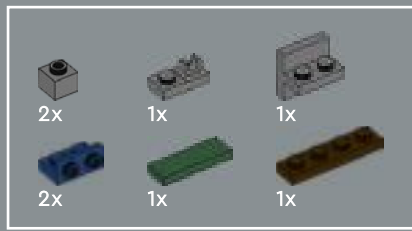

352

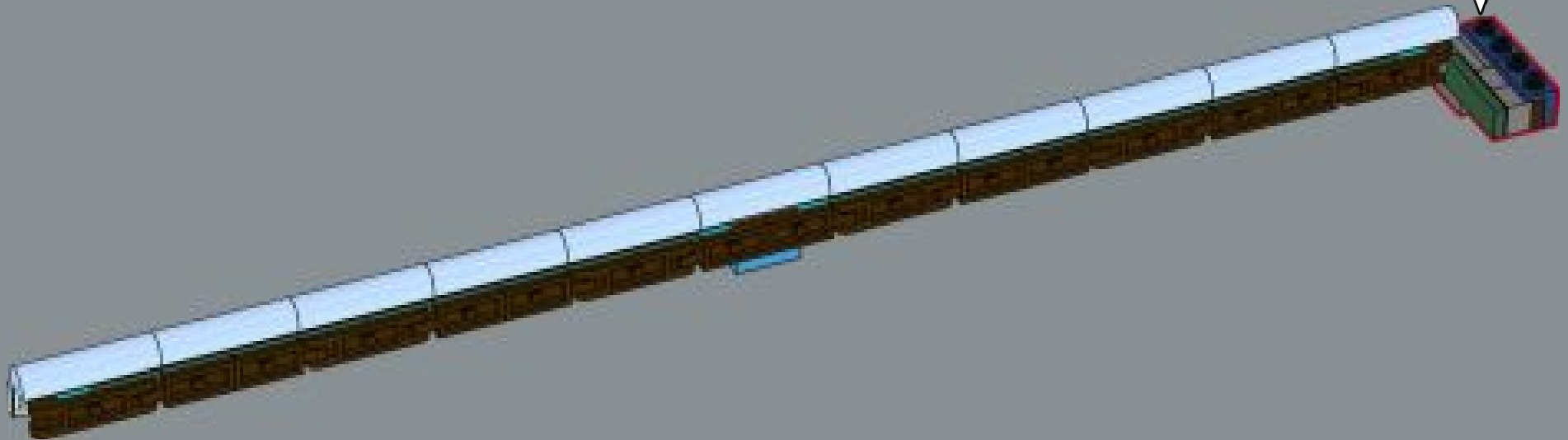
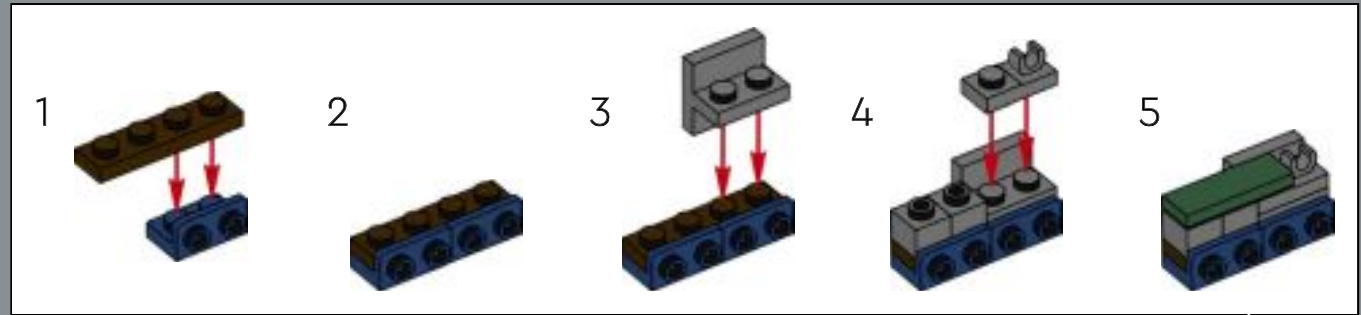



353

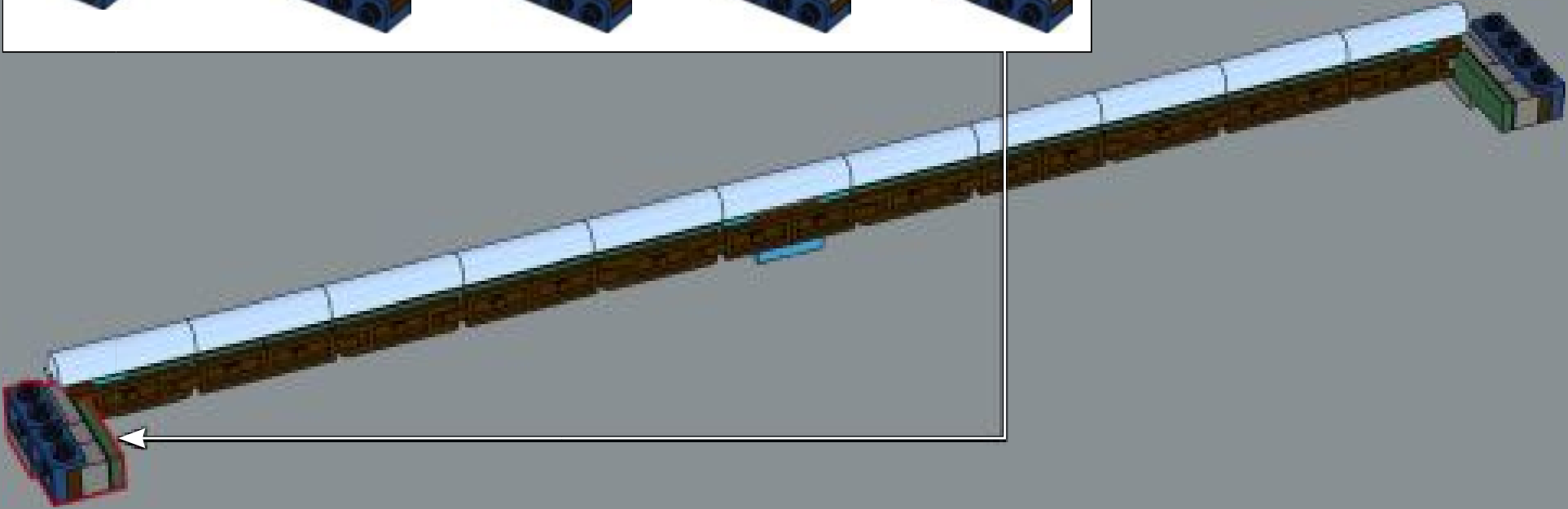
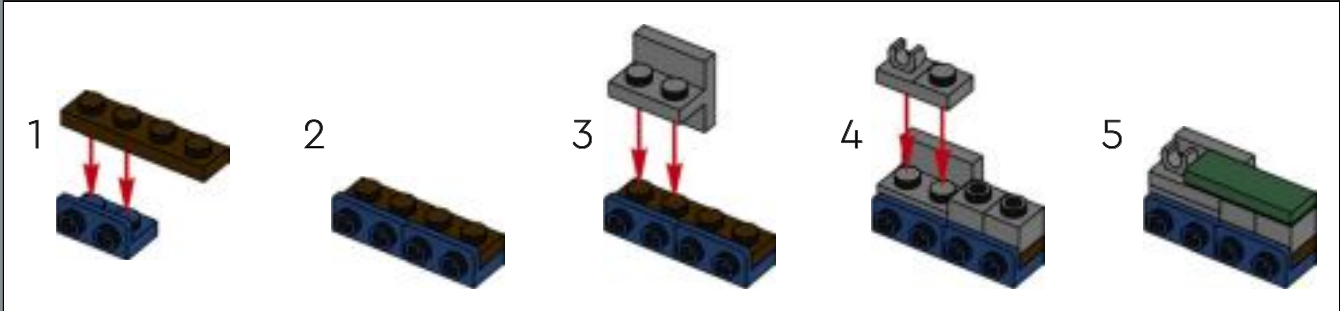



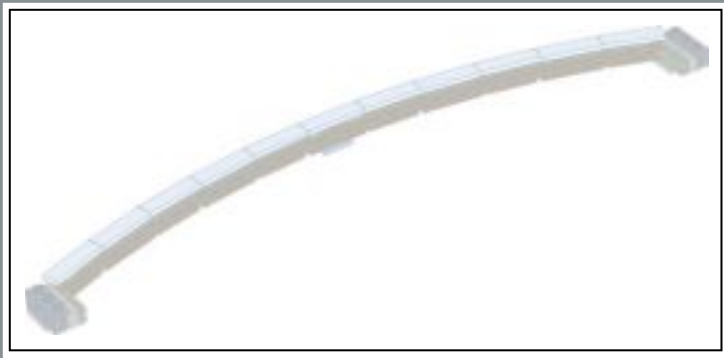

355



356



357

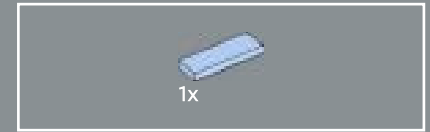

358

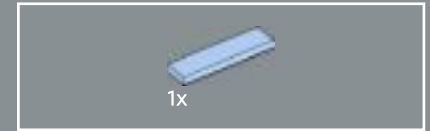

359

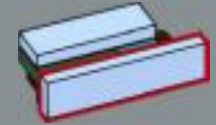



360

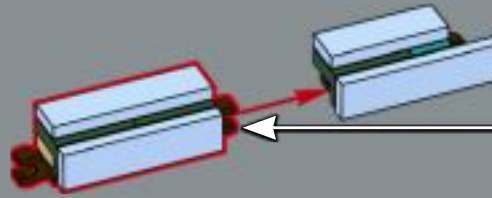
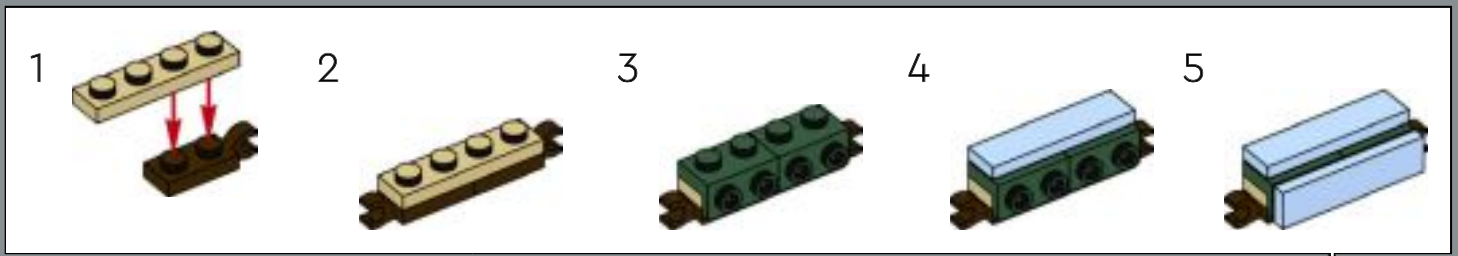

361

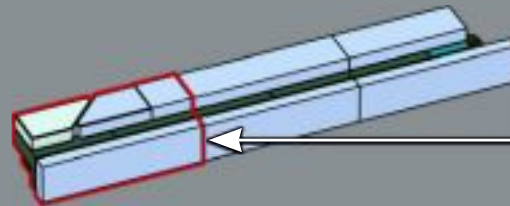

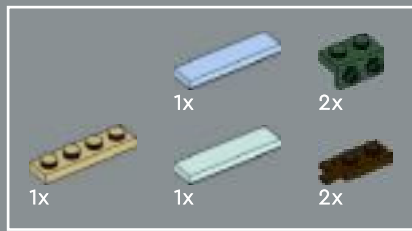

362

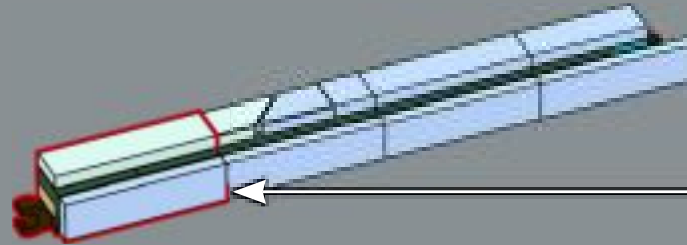
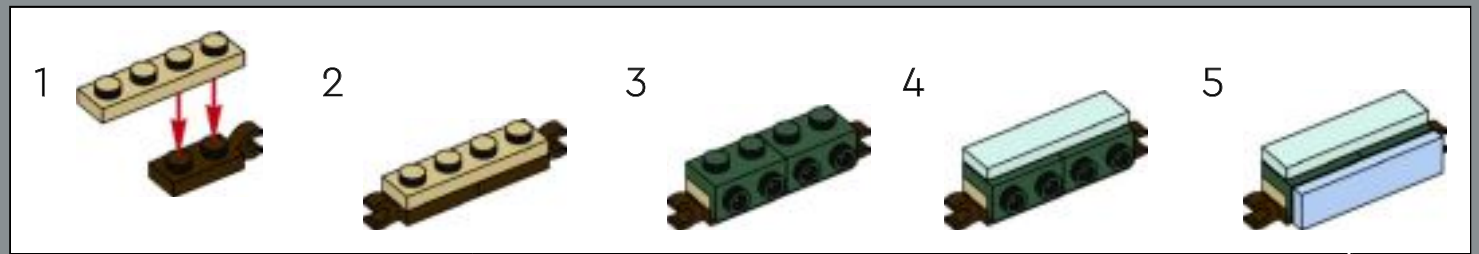

363

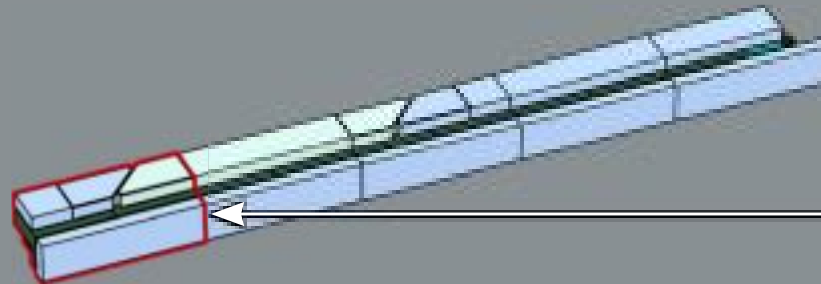



364

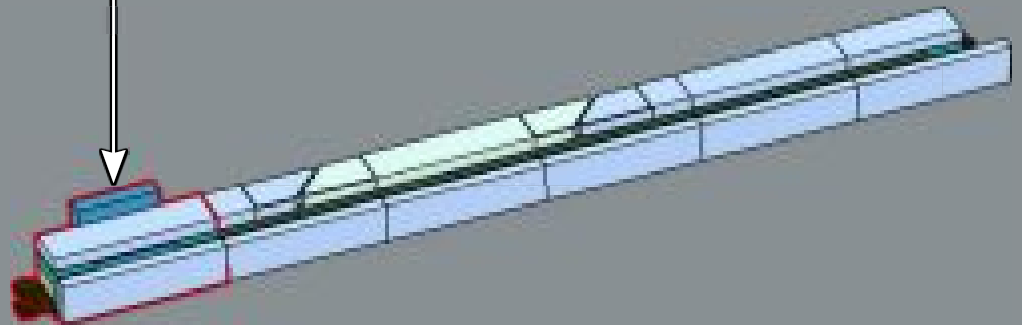
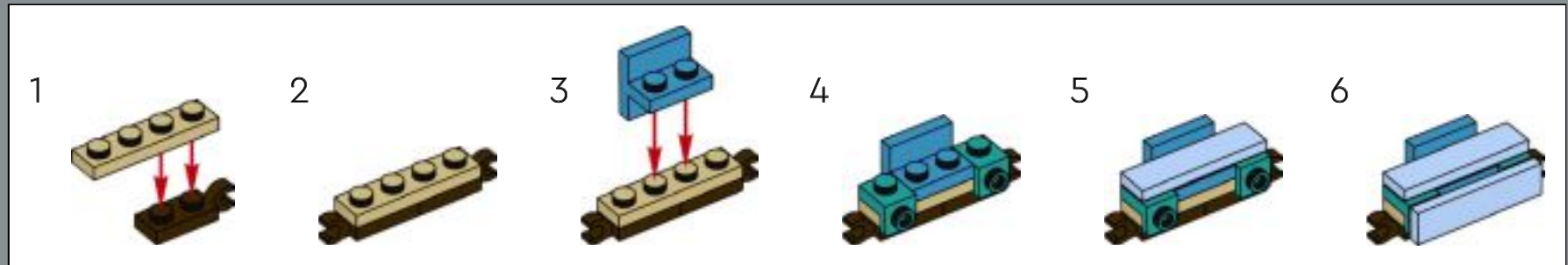



365

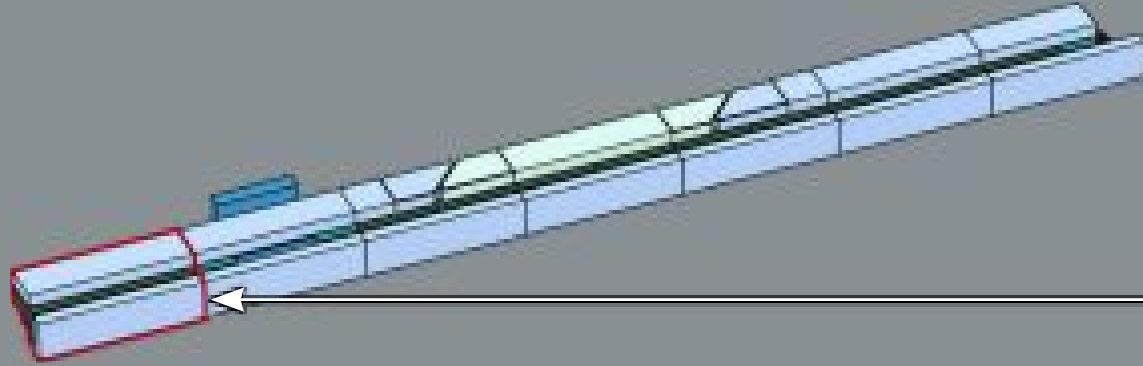

366

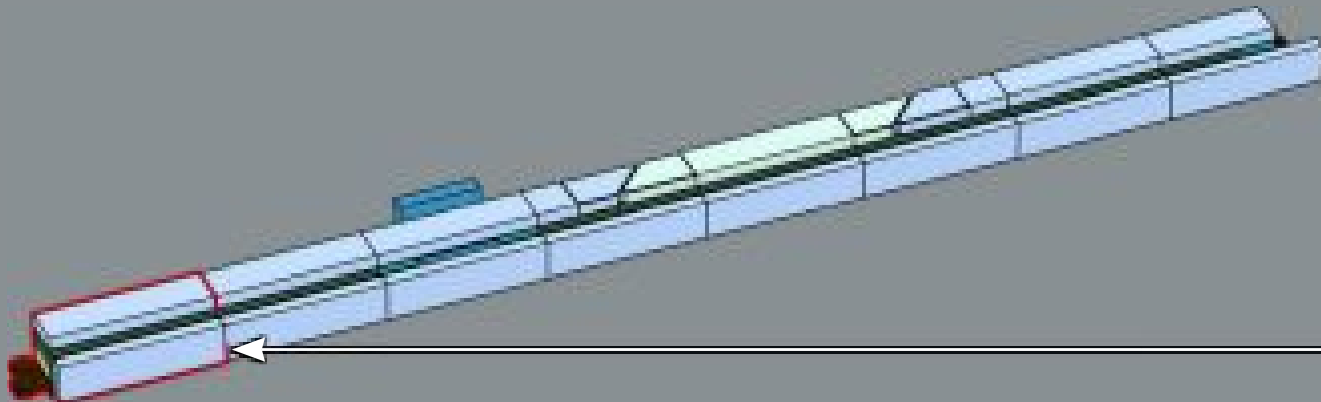
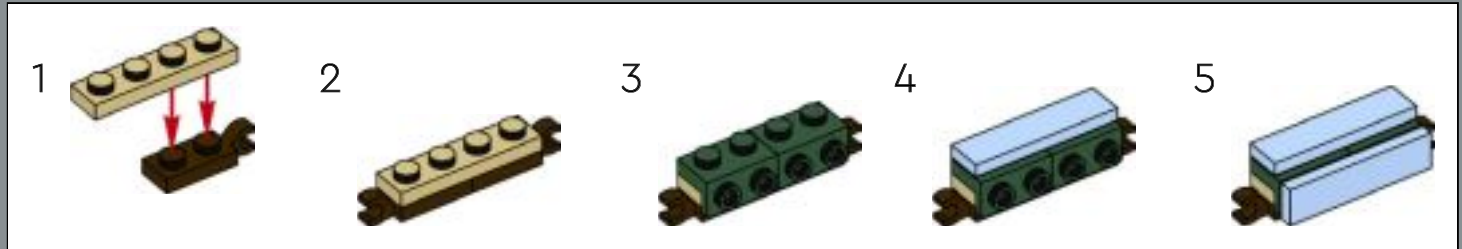



367

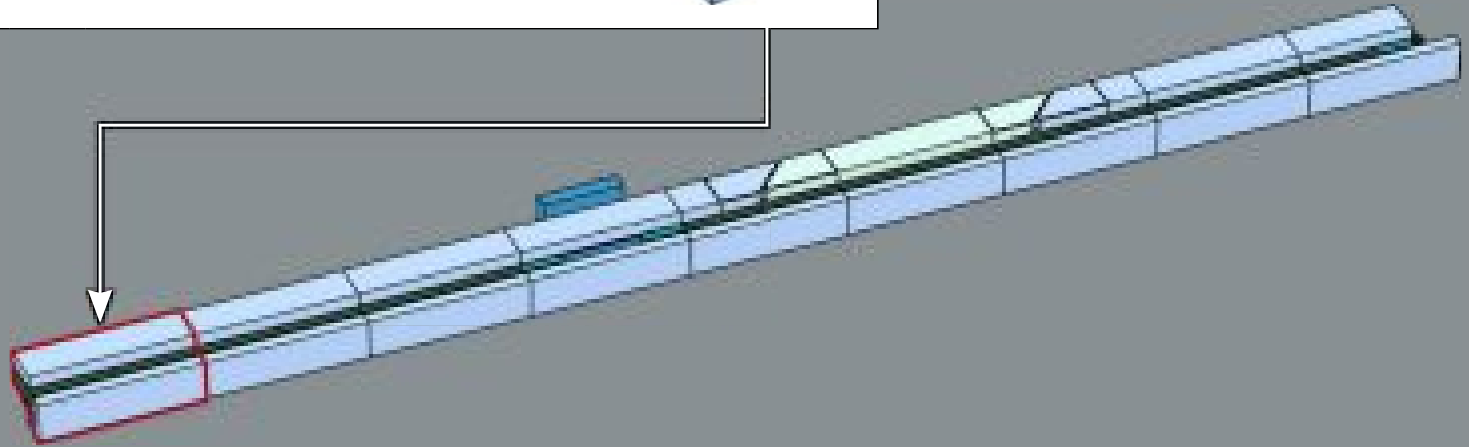



368

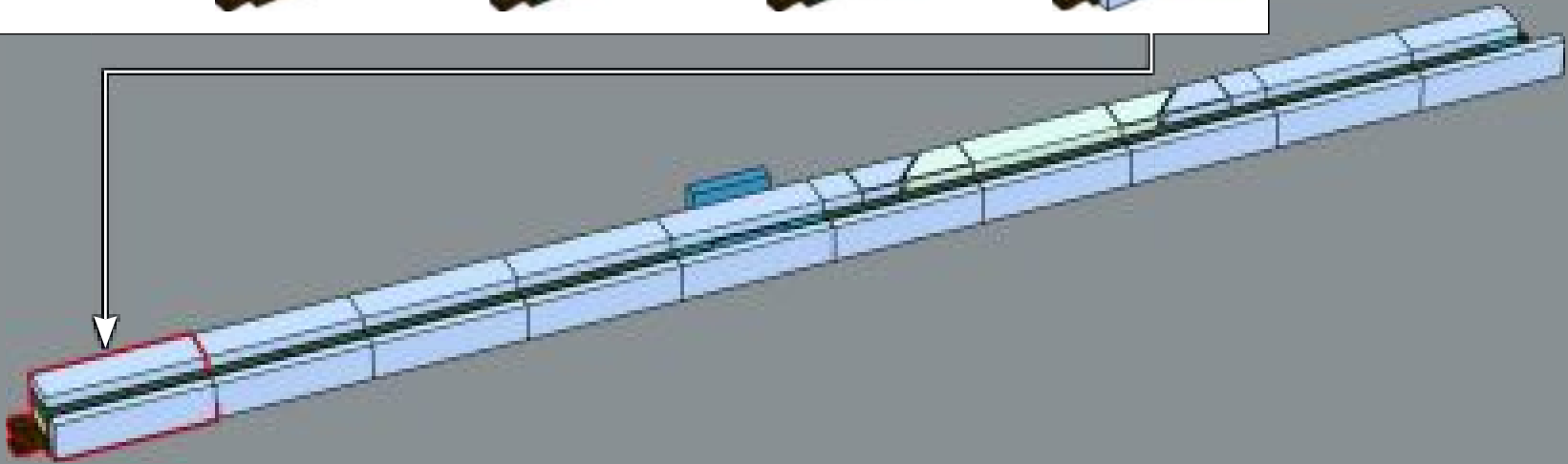



369

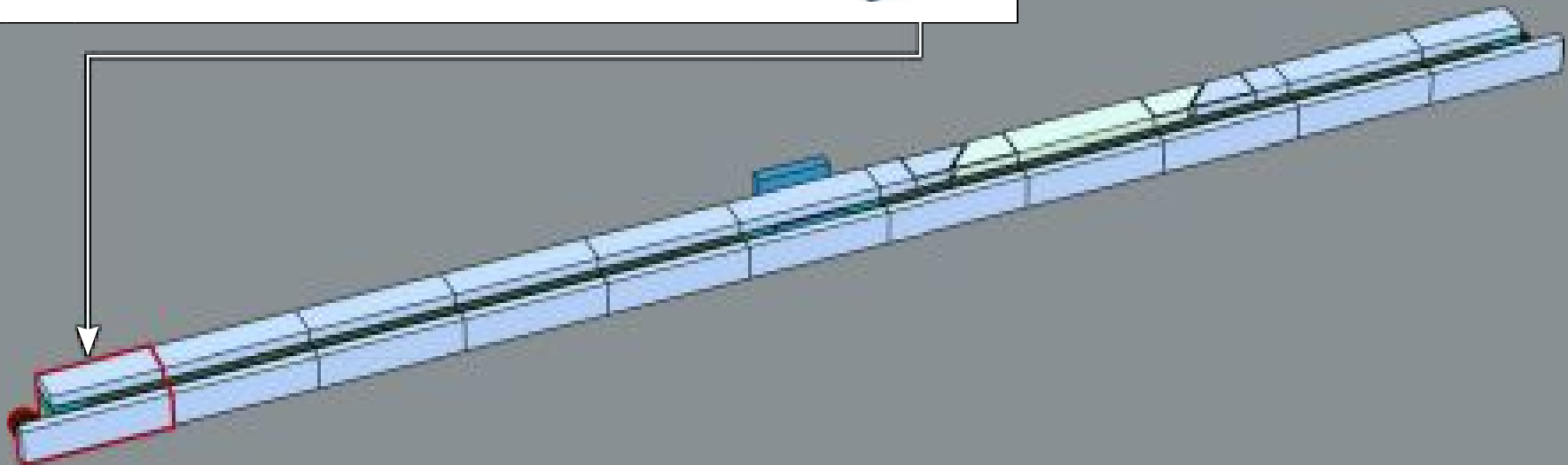



370

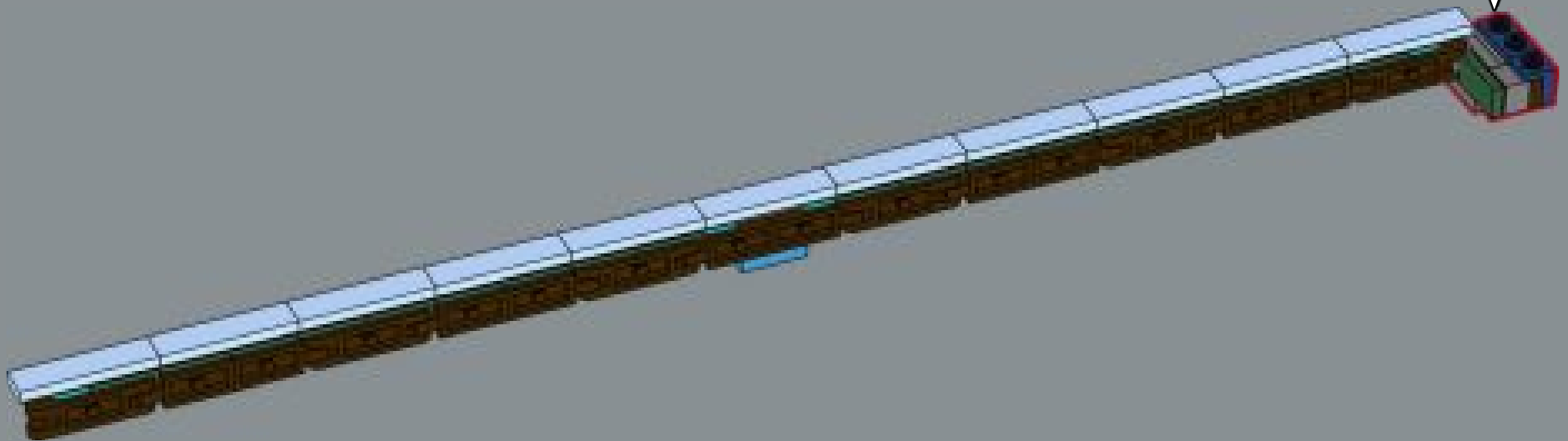
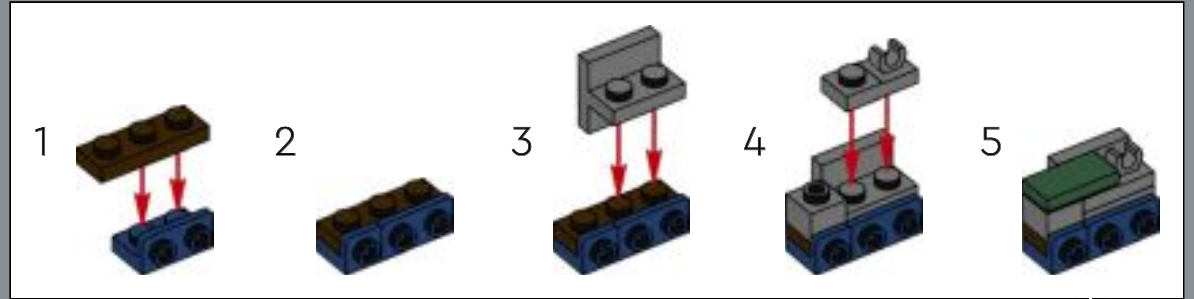



371

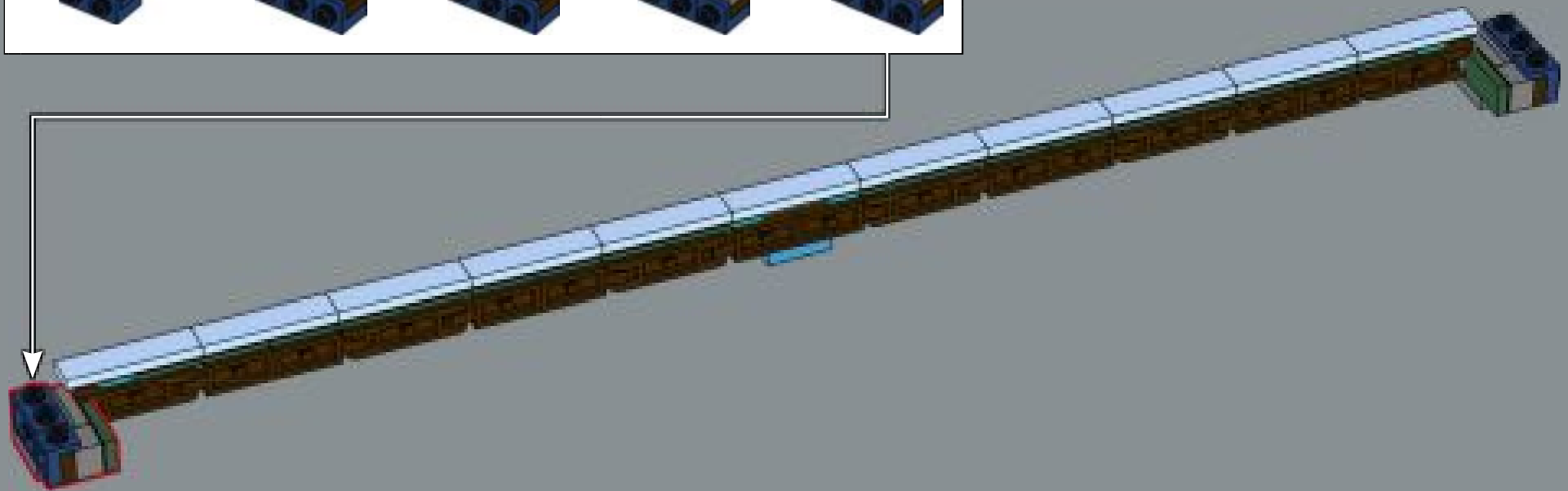
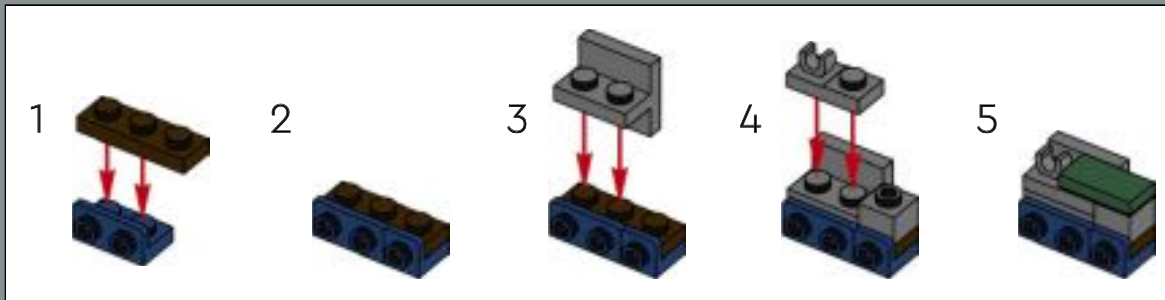



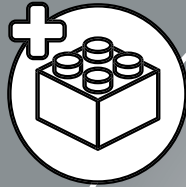

1x

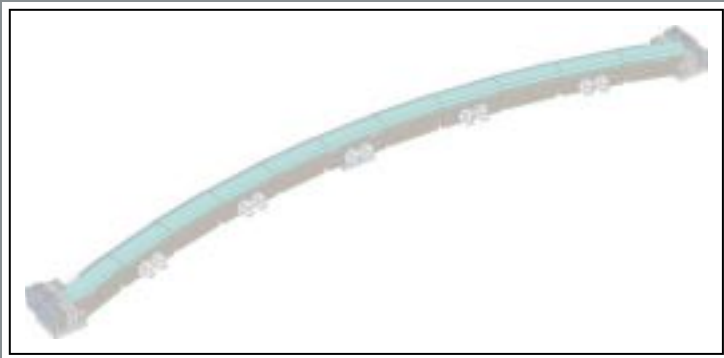

373



374



375

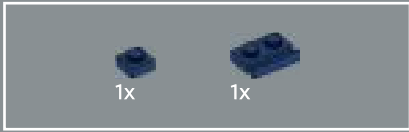

376

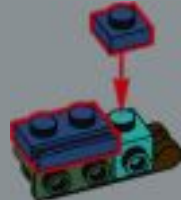

377

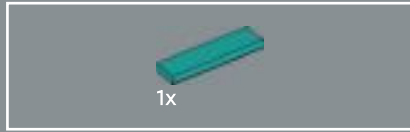

378





379

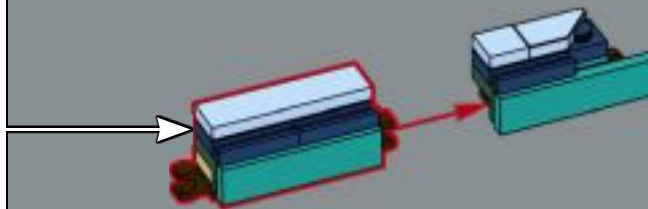
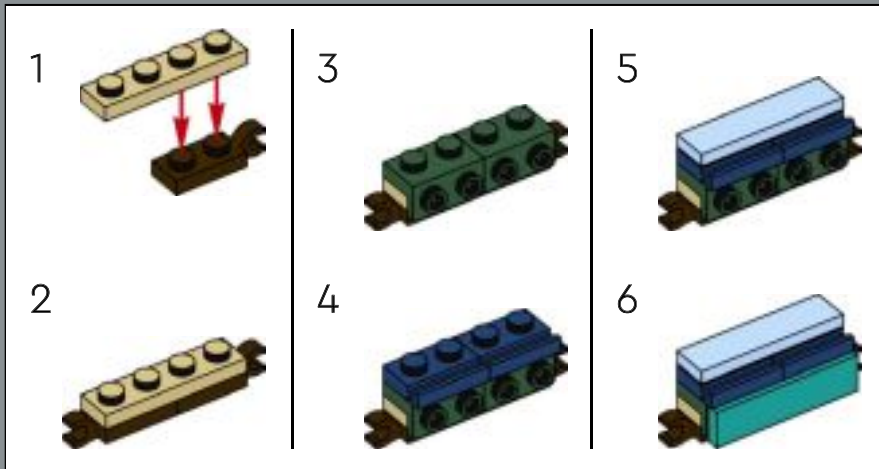



380

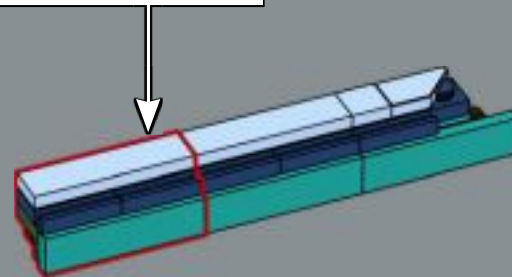
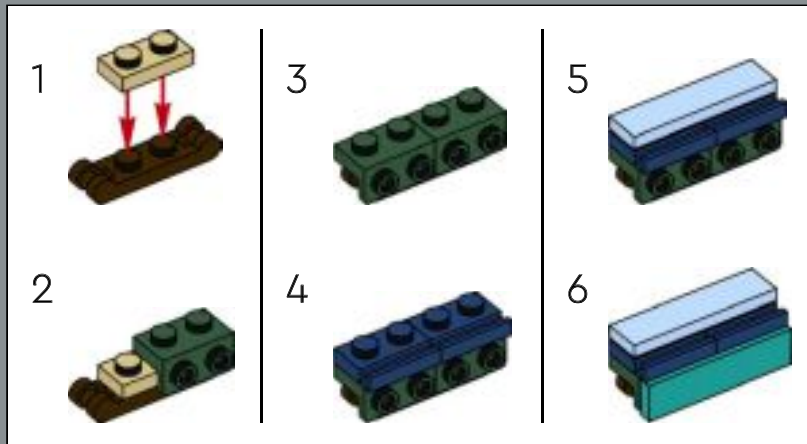



381

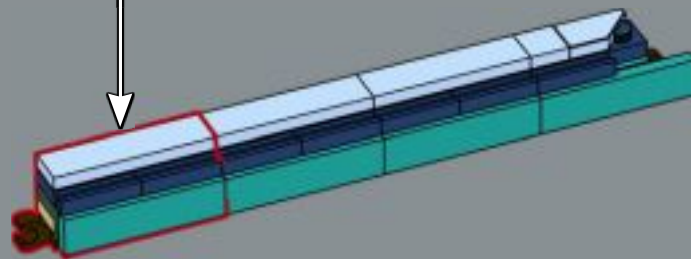
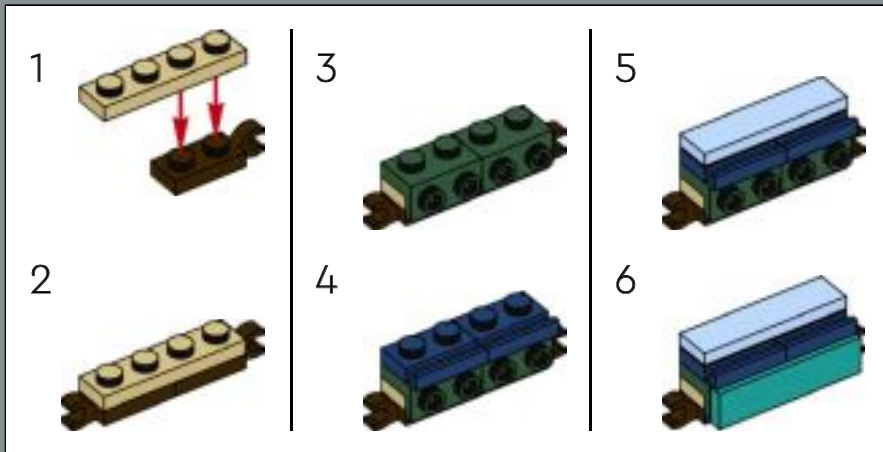



382

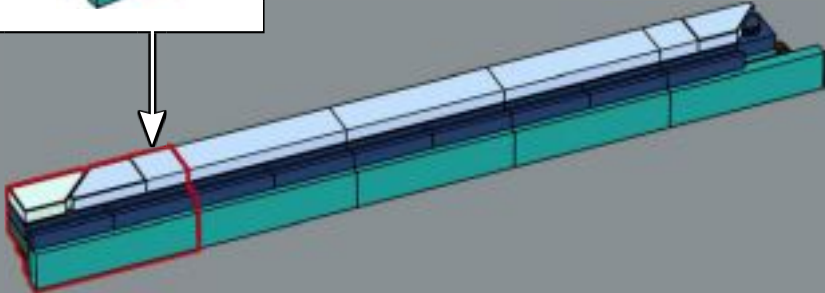
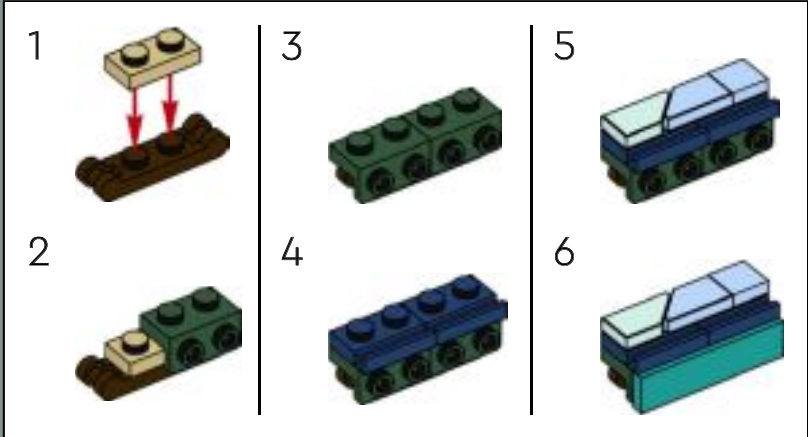

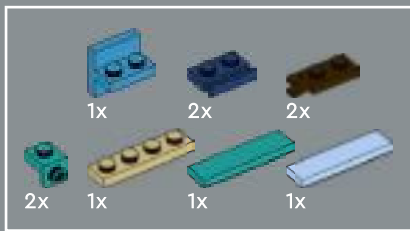

383

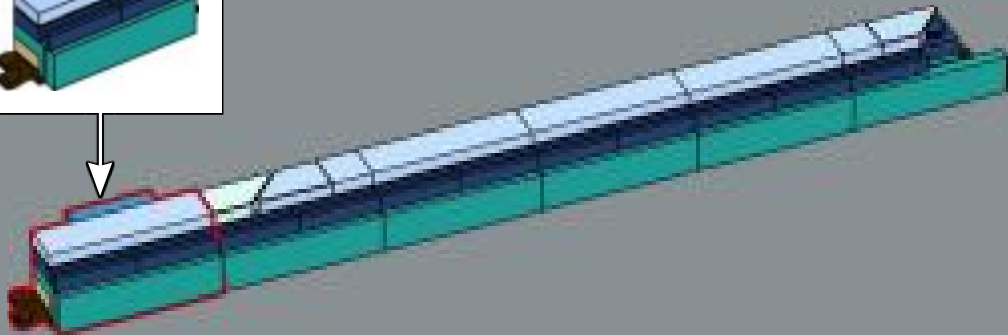
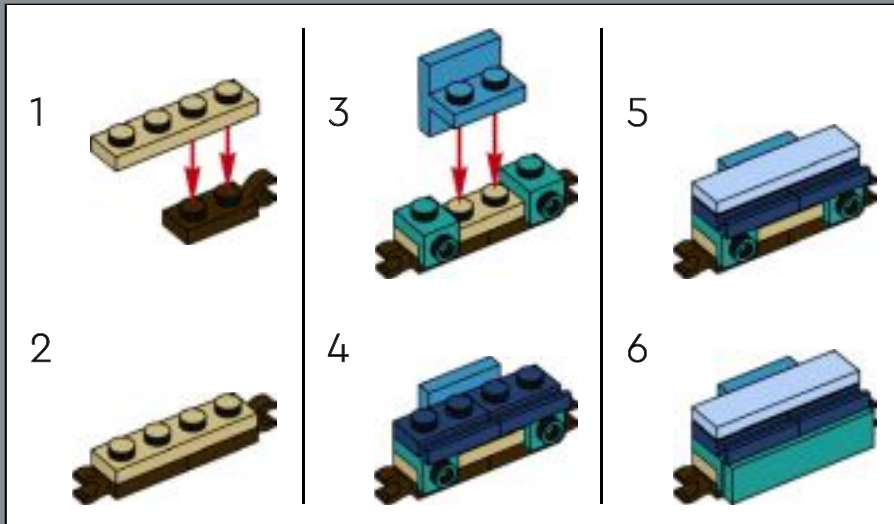



384

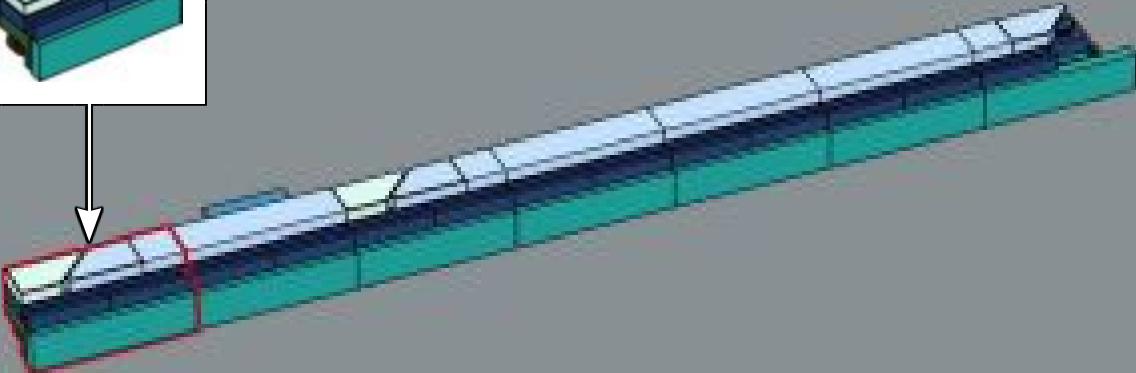
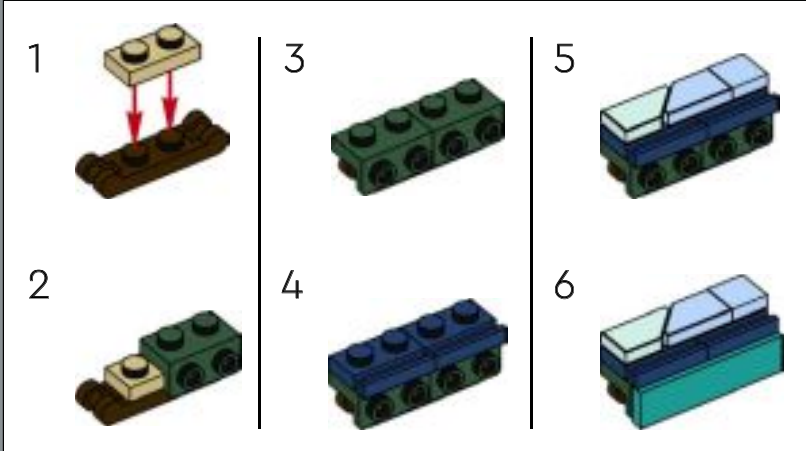



385

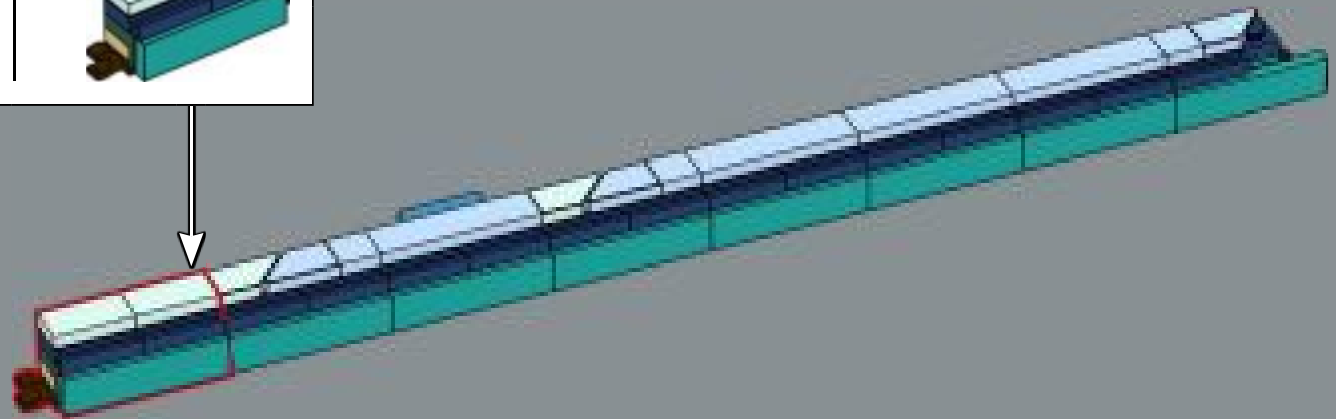
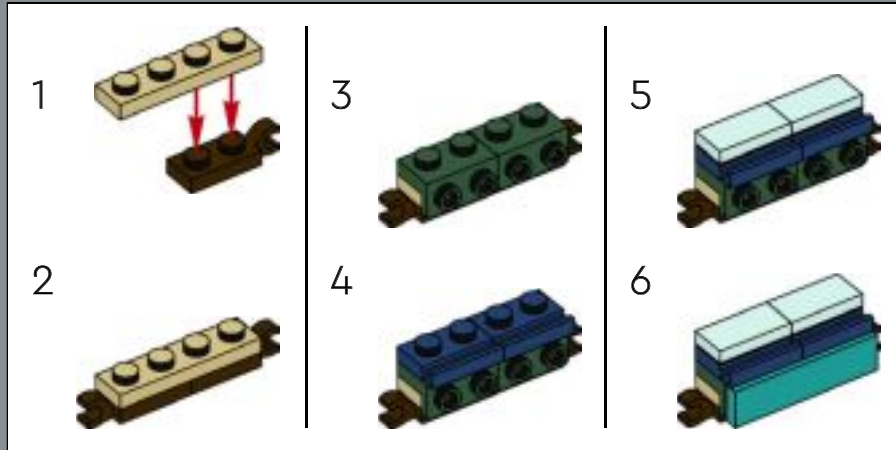



386

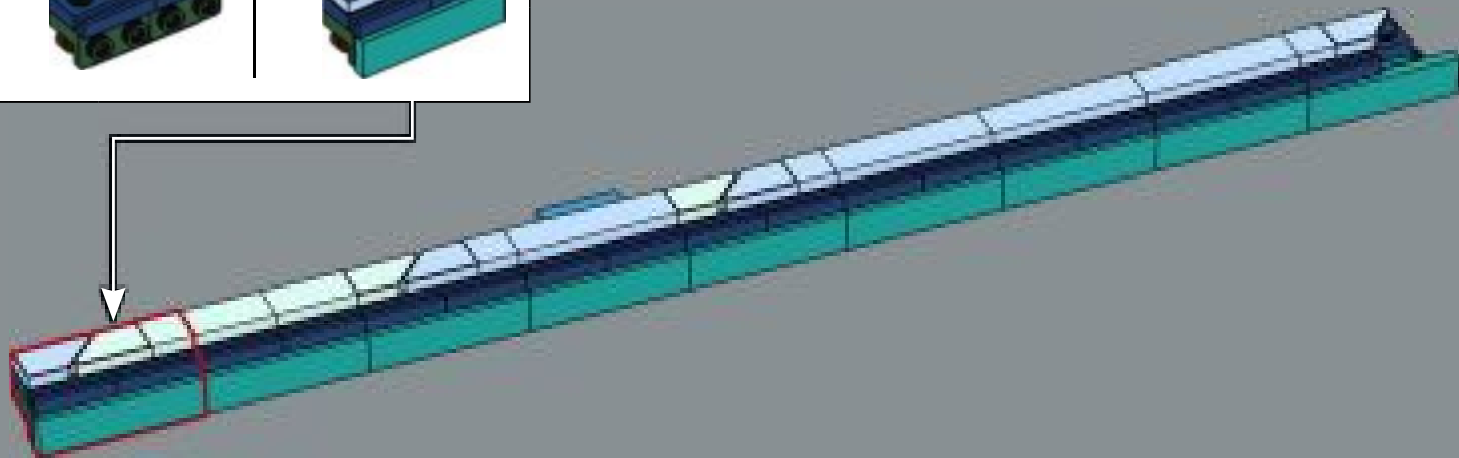
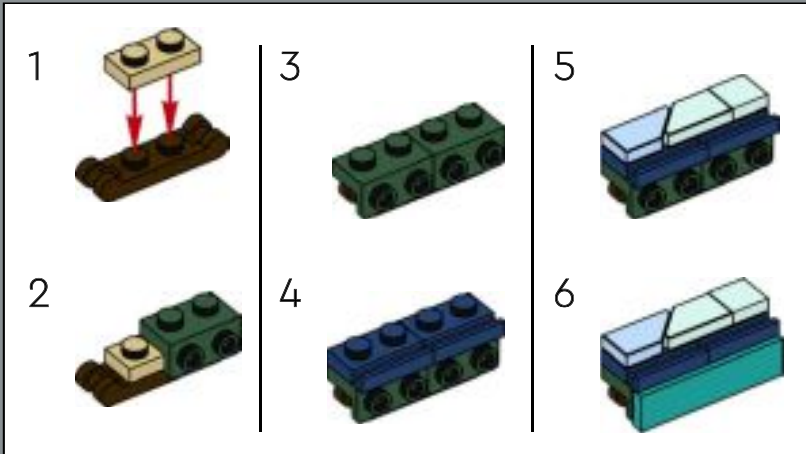



387

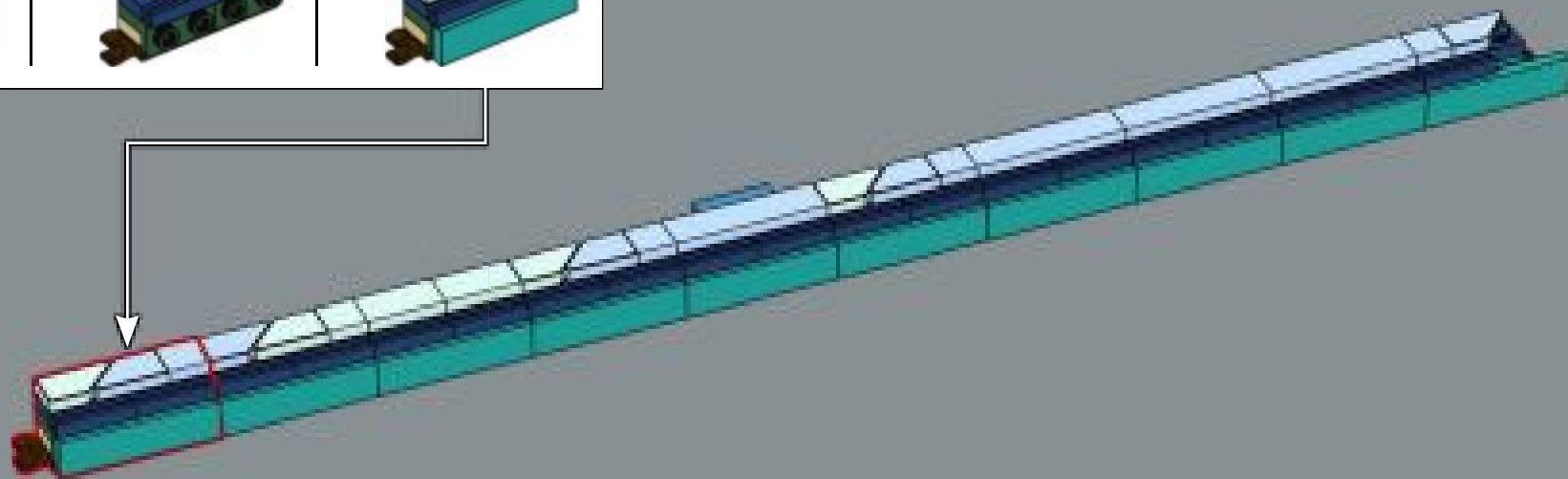
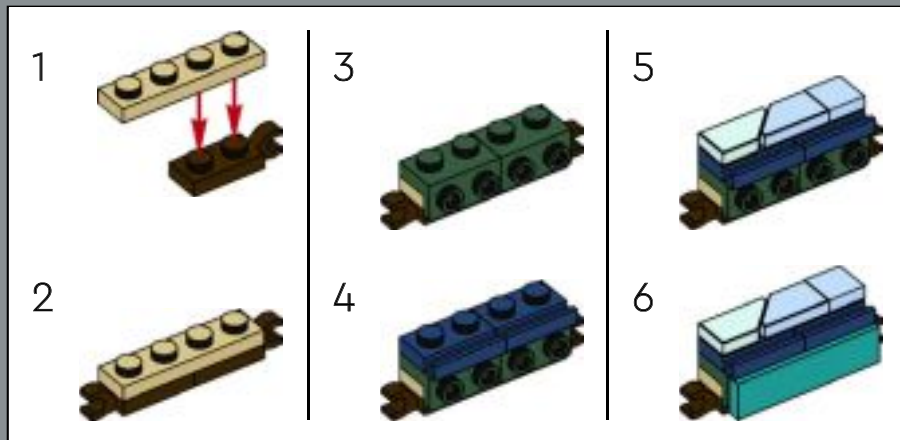



388

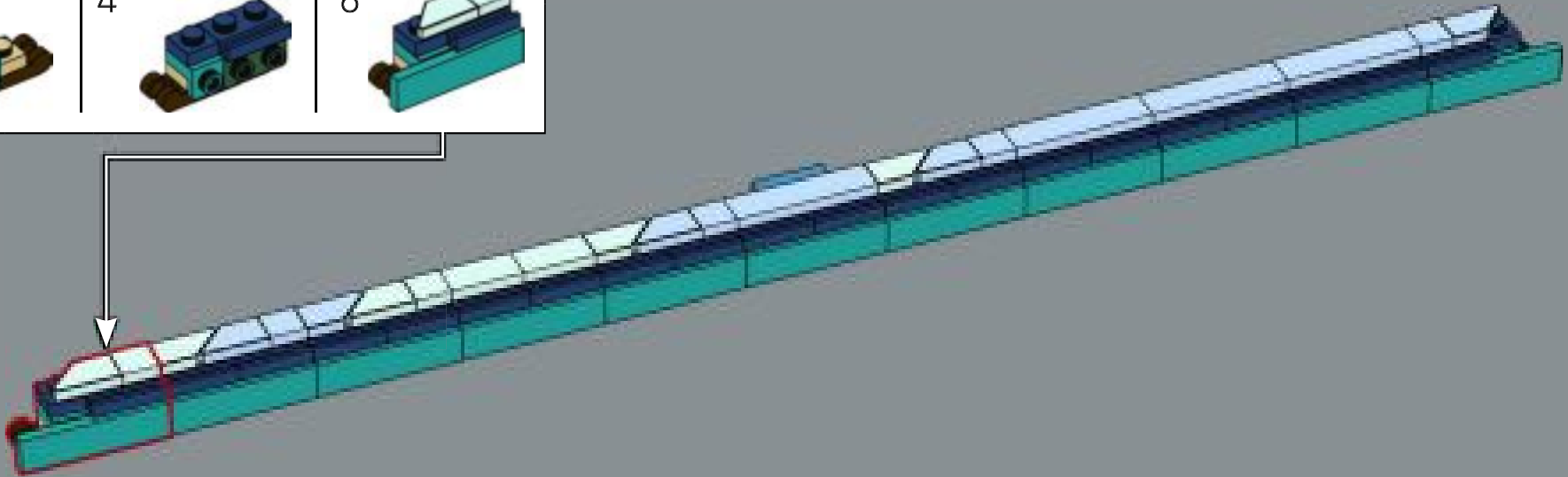
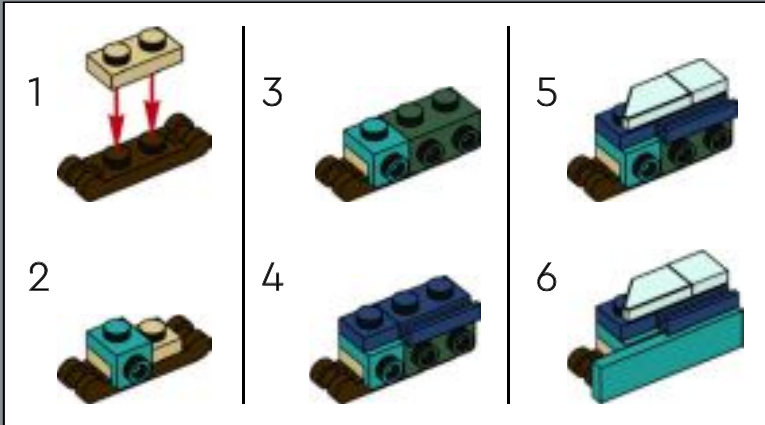



10x

389

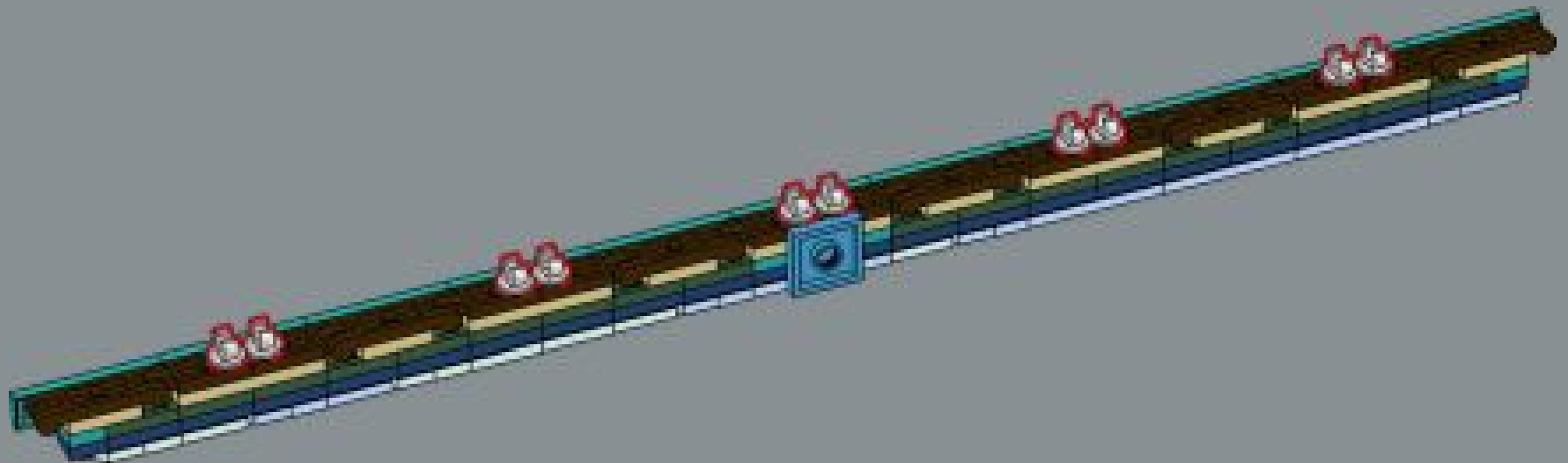



390

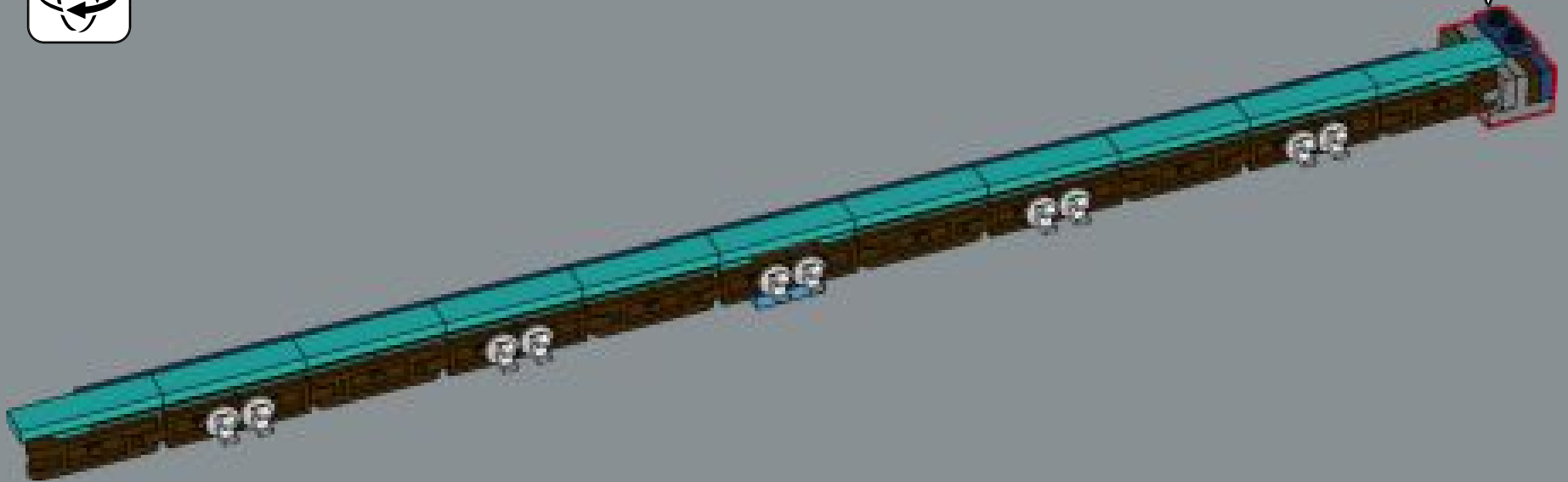
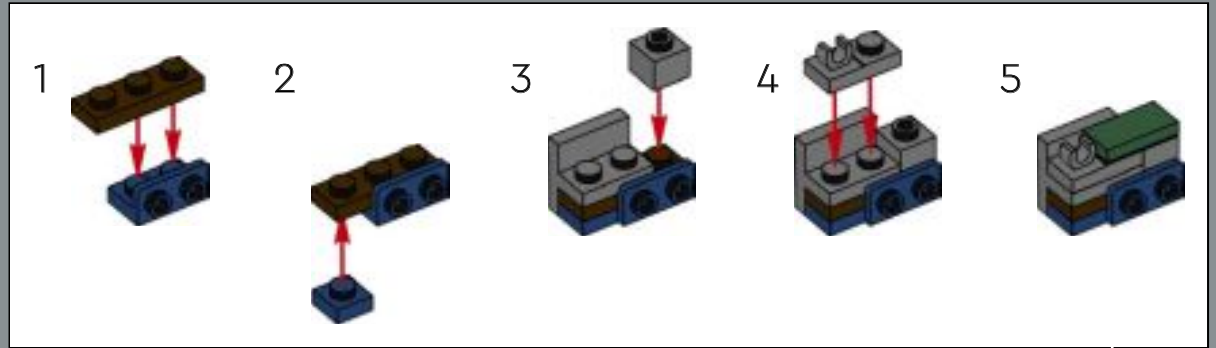



391

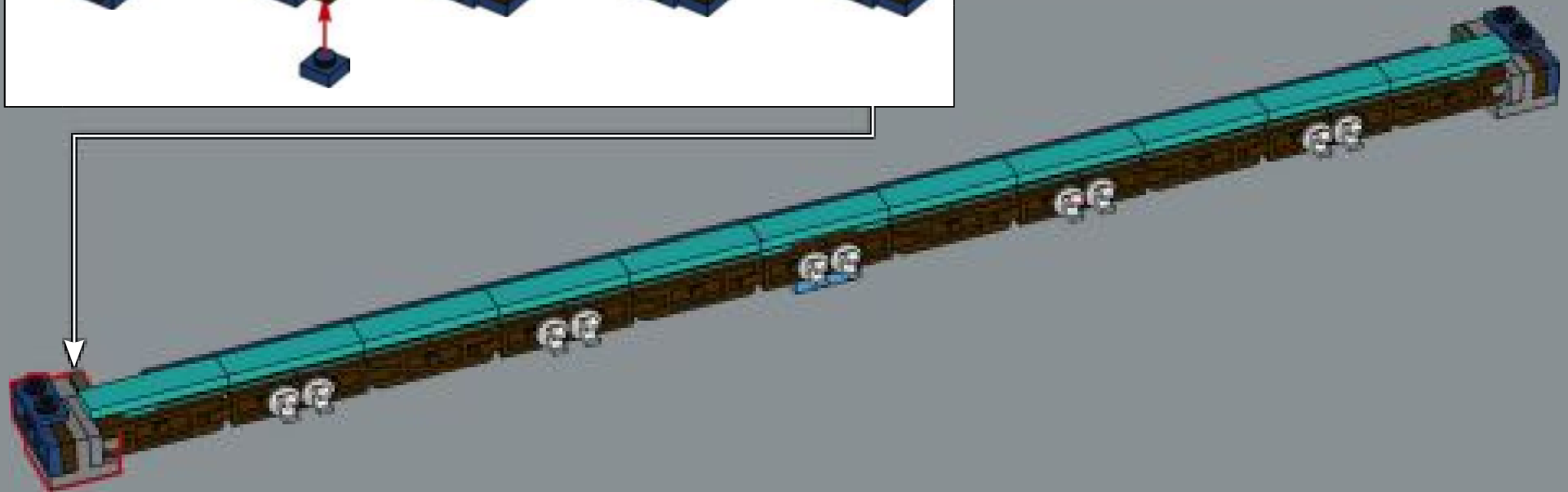
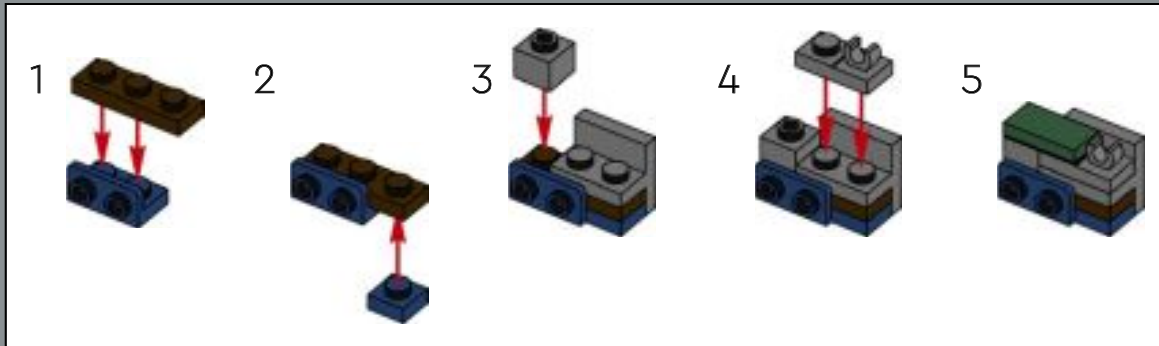





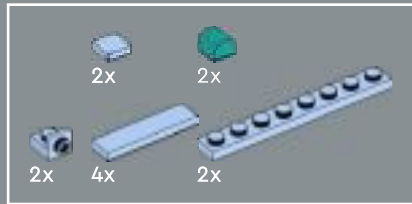

394

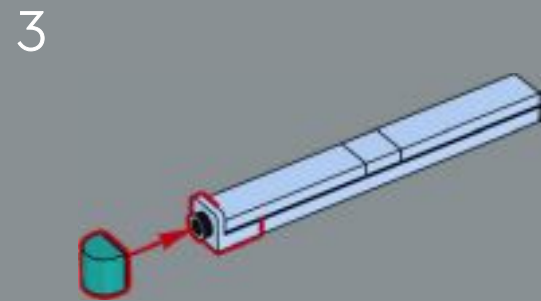
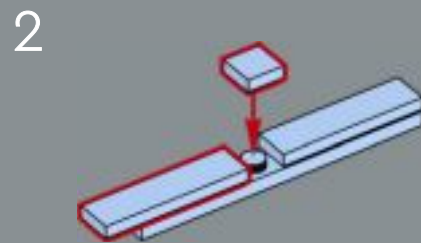
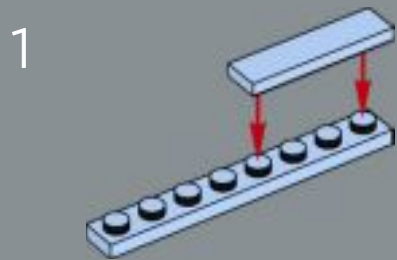

2x



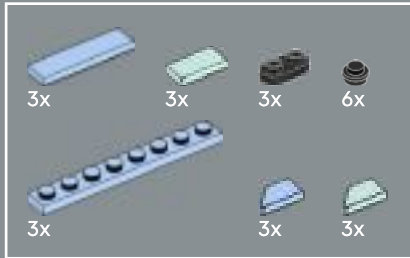
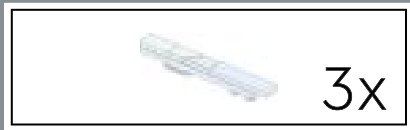

395

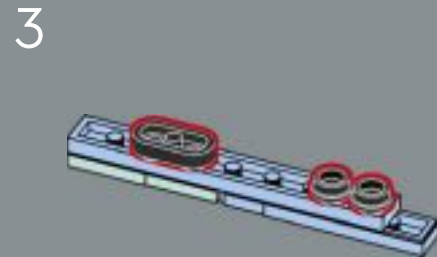
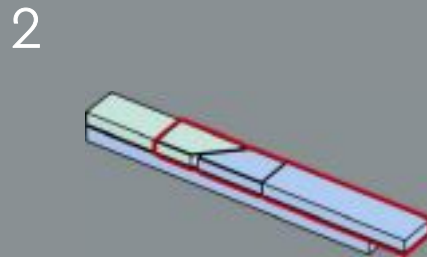
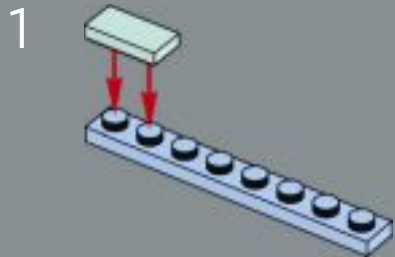
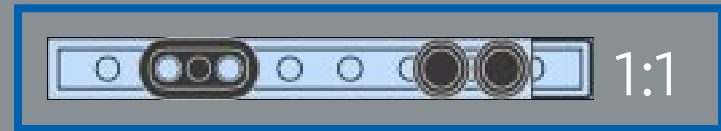

3x

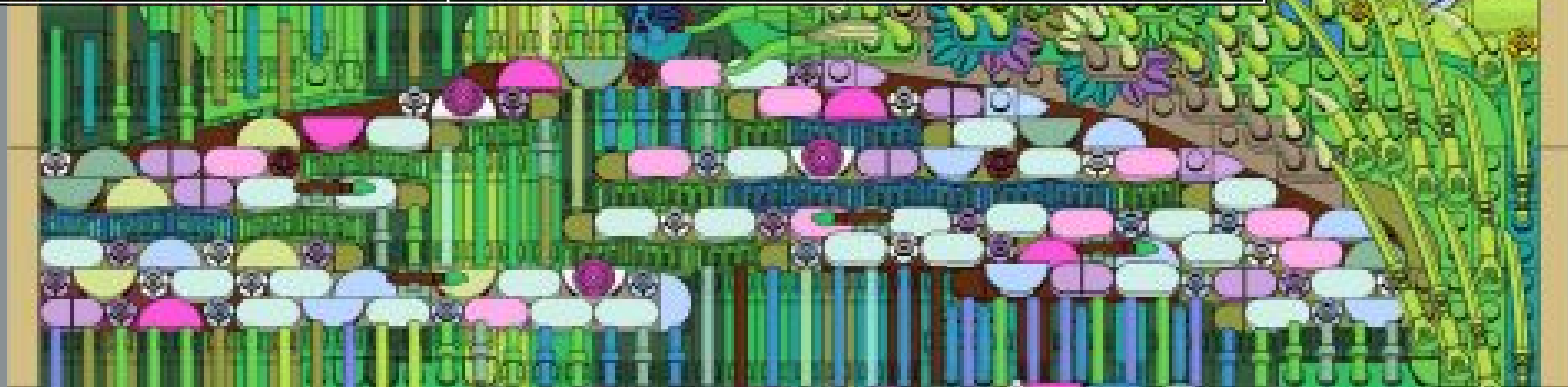

396



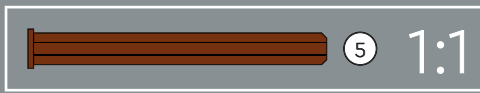

397





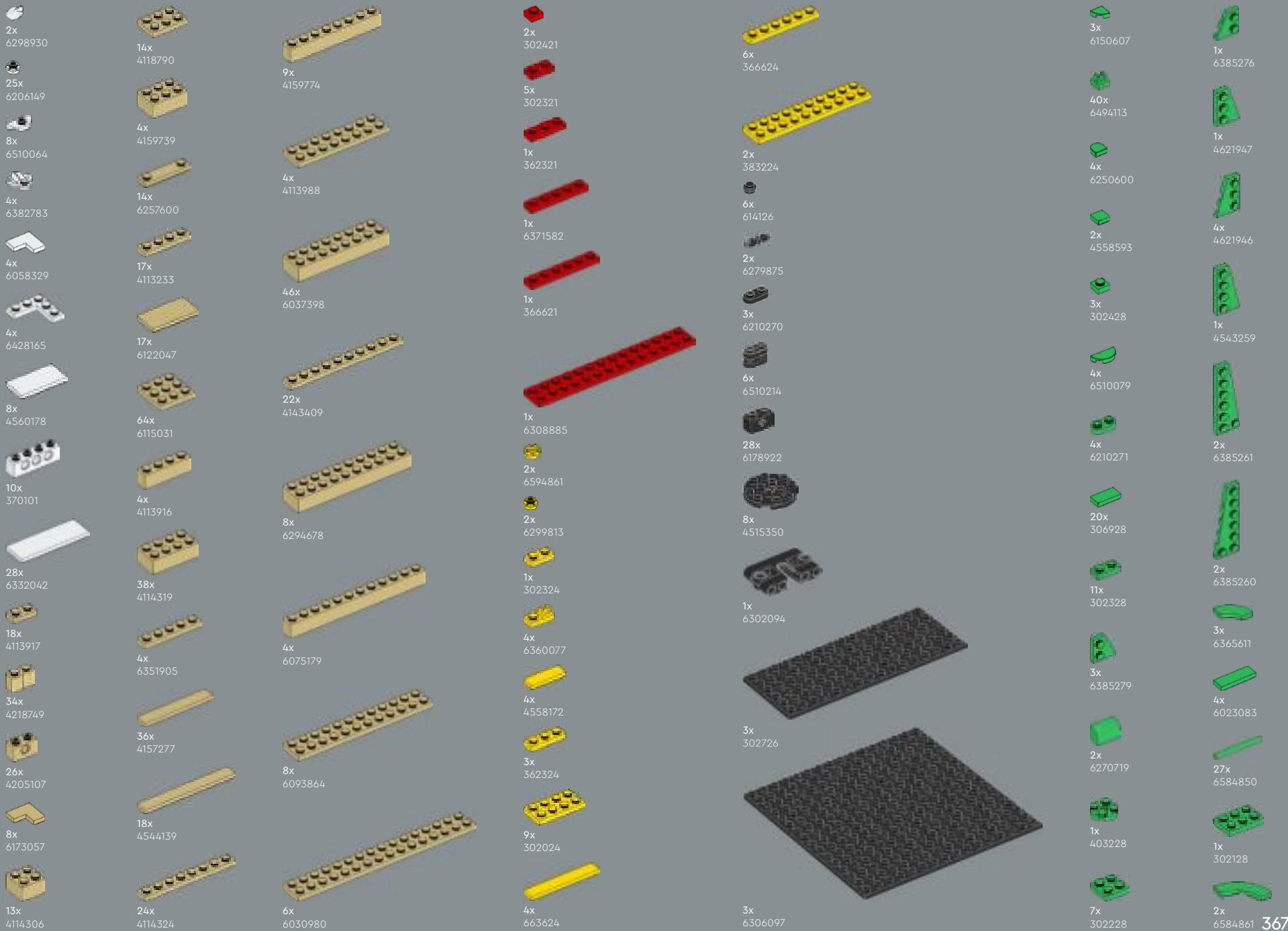

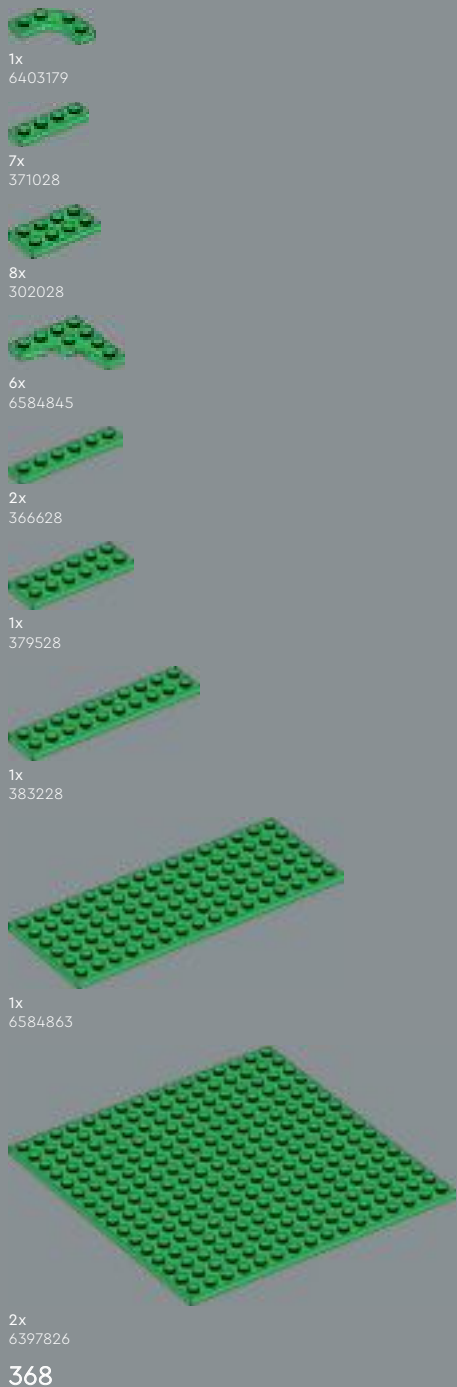

1x
6403179

7x
371028

8x
302028

6x
6584845

2x
366628

1x
379528

1x
383228

1x
6584863

1x
6584863

2x
6397826

2x
6397826

368

4x
6359662

5x
6405702

31x
6275873

57x
6536986

1x
6401817

14x
6400649

7x
6206150

4x
6172375

28x
6596496

19x
6536987

1x
6534935

1x
6527816

2x
6343326

14x
6195258

12x
6182261

17x
6596501

8x
6542391

1x
6534933

1x
6523385

3x
6542390

1x
6542389

4x
6498802

5x
6382958

7x
6161772

17x
6462578

1x
6357612

7x
6294513

7x
6294357

1x
6406233

4x
6395814

4x
6195267

3x
6141590

9x
6423952

3x
6331548

3x
4617799

1x
6462430

10x
6542392

4x
6489990

11x
6507882

1x
366623

1x
6240515

1x
6240467

1x
6240515

1x
6240515

1x
6240515

1x
6240515

1x
6240515

2x
6295358

4x
6213782

12x
6584798

19x
6491440

4x
6482693

4x
6270179

11x
6213779

3x
6213777

4x
6210400

24x
6596521

5x
6334098

2x
6350418

11x
6292786

9x
6584877

29x
6601014

20x
6211875

43x
6584891

2x
6435720

3x
6312452

1x
6250601

6x
4537251

10x
4212454

6x
6420268

16x
6286831

13x
6264062

9x
4500125

3x
4164037

6x
6596506

1x
6310290

3x
4539907

22x
6584846

5x
6441114

1x
4537937

5x
4518611

1x
4210210

1x
6013530

1x
6517742

3x
4164021

2x
6212989

9x
6372804

3x
4621548

8x
6601021

4x
6198156

3x
6248957

4x
6553757

4x
6300322

6x
6231386

1x
4521914

4x
6385277

1x
6002847

1x
6338985

2x
6385281

1x
6385280

1x
6449564

1x
6449564

15x
6603592

8x
6371455

2x
6310830

1x
4550168

1x
4255416

1x
6035540

2x
6001822

4x
4267874

4x
4247145

2x
4550329

2x
6462497

4x
6444941

4x
4184108

15x
6603592

8x
6371455

1x
6251381

1x
6385259

1x
6214808

20x
6363600

1x
6037890

1x
4177735

32x
6315608

2x
6554615

14x
6446790

98x
6348061

1x
6312450

8x
6055171

1x
6512536

21x
6423382

9x
6400754

32x
6326011

10x
6192250

54x
6586931

7x
6584866

1x
6526022

1x
6214291

1x
4648340

5x
6527810

4x
6426639

7x
4650622

3x
4528778

3x
4543949

2x
4586057

3x
4260493

2x
6554609

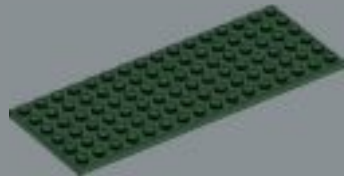

2x
6584857

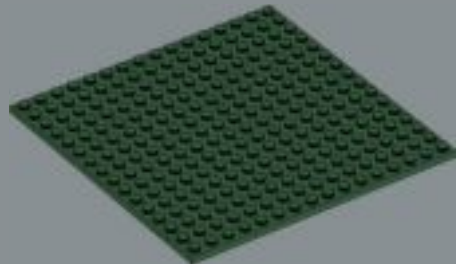

4x
6584848

3x
6316573

13x
6348059

1x
6099189

12x
6546184

13x
6530975

1x
4655080

2x
6233984

4x
6584874

2x
6100234

2x
6249817

7x
6458394

24x
6212040

2x
4539071

1x
6586570

5x
6432033

5x
6348057

3x
6328180

2x
6510060

5x
6451002

5x
6078605

3x
4211151

3x
4211150

4x
4211180

3x
6385263

2x
6021336

1x
4205469

3x
4205470

5x
6503733

5x
6503732

17x
4216695

2x
4211257

6x
4211200

4x
4211152

2x
6116613

6x
4211189

6x
4211181

14x
6159763

1x
4211186

18x
4211201

3x
4221590

2x
4216945

5x
4211211

33x
4225700

5



8x
6388133



2x
4211063



6x
6344754



2x
4211095



4x
4211055



1x
4210635



6x
6250018



3x
4257526



1x
4210678



3x
4257526



1x
4210678



3x
4257526



1x
4210678



3x
4257526



1x
4210678



3x
4257526



10x
6601012



2x
6383095



8x
6316569



49x
6209683



10x
6603597



1x
6590679



32x
6587510



10x
6510147



13x
6420914



2x
6097861



3x
6372225



11x
6596500



30x
6468267



5x
6372125



5x
6372125



5x
6372125



3x
6596503



4x
6426463



6x
6545172



2x
6296501



3x
6275872



1x
6480357



10x
6190252



1x
6462538



2x
6194729



3x
6568024



4x
6058221



1x
6058221



2x
6542683



2x
6542683



2x
6542683



2x
6542683



2x
6542682



30x
6347286



4x
6518013



1x
6494115



18x
6596482



6x
6252667



2x
6223039



6x
6507884



13x
6199887



16x
6584858



4x
6313557



1x
6151664



3x
6151658



7x
6596481



2x
6251846



2x
6251846



15x
6596478



2x
6151659



1x
4653988



12x
6219248



2x
6145418



1x
6565474



3x
6145416



4x
6199897



1x
6153538



3x
6424641



6x
6584851



2x
633728



2x
6251846



14x
6584868



16x
6186030



20x
6601015



10x
6596485



80x
6584887



5x
6133247



4x
6596494



12x
6102537



32x
6329119



42x
6214235



2x
6468342



17x
6275487



9x
6584886



28x
6541652



4x
6601020



16x
6186030



16x
6186030



16x
6186030



16x
6186030



16x
6601022



8x
6483528



5x
6058245



40x
6398008



6x
6100158



9x
6016483



32x
6584889



2x
6473460



10x
6278088



3x
6079617



2x
6058220



1x
632965



2x
6058220



1x
632965



1x
632965



1x
632965



5x
6186030



2x
6020144



13x
6278089



5x
6398503



8x
6210460



4x
6550578



10x
6529298



23x
6507796



1x
6552654



3x
6326478



16x
6596480



2x
6167464



2x
6167464



2x
6167464



2x
6167464



2x
6167464



[LEGO.com/service](https://www.LEGO.com/service)



YOU COULD
WIN



**YOU COULD
WIN**

Your feedback will help shape the future development of this product series.

Visit:

**DU KÖNNTEST
GEWINNEN**

Dein Feedback trägt zur Weiterentwicklung dieser Produktreihe bei.

Geh auf:

**VOUS POURRIEZ
GAGNER**

Vos commentaires nous aideront à concevoir les futurs produits de cette gamme.

Visitez :

**POTRESTI
VINCERE TU**

La tua opinione ci aiuterà a migliorare la creazione futura di questa linea di prodotti.

Visita:

**PUEDES
GANAR**

Tu opinión contribuirá al futuro de esta serie de productos.

Visita:

轻松获奖

您的反馈将有助于我们在今后改进本产品系列。

请访问:

LEGO.com/productfeedback

You also have the chance to win a LEGO® set.

Terms and conditions apply.*

Außerdem hast du die Chance, ein LEGO® Set zu gewinnen.

Es gelten die Teilnahmebedingungen.*

Vous pourriez également gagner un ensemble LEGO®.

Des conditions s'appliquent.*

Hai anche la possibilità di vincere un set LEGO®.

Termini e condizioni sono applicabili.*

También tienes la oportunidad de ganar un set LEGO®.

Aplican términos y condiciones.*

您还有机会赢取乐高®套装。

条款和条件适用。*

*LEGO.com/productfeedback-terms

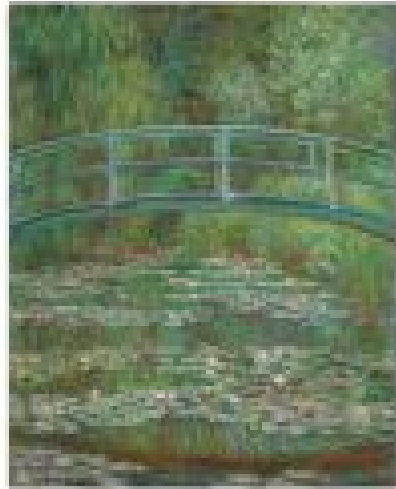

LEGO and the LEGO logo are trademarks of the LEGO Group. ©2026 The LEGO Group.
© The Metropolitan Museum of Art

 6632971